



PLASTIC PIPING SYSTEMS 2021









Validità dal 19 aprile 2021

TABELLA SCONTI

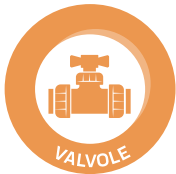
Gentile Cliente,

per rendere più semplice la consultazione dei nostri cataloghi e l'acquisto dei prodotti, abbiamo deciso di dividere le fasce sconto in 8 categorie: **Raccorderia PVC-U, Adesivi Solventi e Teflon, Valvole, Evacuazione, Valvole industriali Extreme, Raccorderia PVC-C, Tubo semirigido, Tubo rigido PVC-U e PVC-C.**

All'interno del catalogo troverà un codice alfanumerico in testa alla tabella prodotto che Le indicherà la categoria di appartenenza. Il Suo funzionario commerciale Le indicherà lo sconto relativo a Lei riservato, per ogni fascia sconto.

	Sconto	Si riferisce al Codice Alfanumerico: C01 (RACCORDERIA PVC-U)
	Sconto	Si riferisce al Codice Alfanumerico: C02 (ADESIVI, SOLVENTI E TEFLON)
	Sconto	Si riferisce al Codice Alfanumerico: C03 (VALVOLE)
	Sconto	Si riferisce al Codice Alfanumerico: C07 (EVACUAZIONE)
	Sconto	Si riferisce al Codice Alfanumerico: C08 (VALVOLE INDUSTRIALI EXTREME)
	Sconto	Si riferisce al Codice Alfanumerico: C19 (RACCORDERIA PVC-C)
	Sconto	Si riferisce al Codice Alfanumerico: T01 (TUBO SEMIRIGIDO)
	Sconto	Si riferisce al Codice Alfanumerico: T02 (TUBO RIGIDO PVC-U E PVC-C)

Esempio*:

UP. 01. SF

Codice Alfanumerico
Discount family

↓
C01 | ACP 010*



GOMITO 90°
incollaggio

90° ELBOW
solvent socket

SIZE	PN	REF.	PACK	kg	Q(B)	Q(P)	CODE	EUR
16	16	05 01 016	B	3,1	200 (20)	24000	11655	XXXXXX
20	16	05 01 020 ^{1 2}	B	2,8	140 (20)	16800	01712	XXXXXX
25	16	05 01 025 ^{1 2}	B	2,8	80 (10)	9600	01713	XXXXXX
32	16	05 01 032 ²	C	5,5	90 (10)	5400	01714	XXXXXX

* Le descrizioni utilizzate nell'esempio sono puramente a scopo indicativo.



COLLABORAZIONE CON I CLIENTI

Aggiungiamo valore per i
nostri utenti e clienti



PASSIONE PER IL SUCCESSO

Siamo dedicati al nostro lavoro,
responsabili e coerenti



ECCELLENZA E INNOVAZIONE

Miglioriamo continuamente ed
aspiriamo ad essere i migliori

I NOSTRI VALORI



ONESTÀ E FIDUCIA

Siamo onesti, trasparenti
e disponibili



APPRENDIMENTO ED ADATTAMENTO

Siamo di mentalità aperta,
flessibili e positivi



LAVORO DI SQUADRA **1+1>2**

Siamo umili e accogliamo tutti

FLUIDRA

THE PERFECT POOL EXPERIENCE

CHI È FLUIDRA

Il nostro portfolio include alcuni dei brand più affidabili sul mercato, come Jandy®, AstralPool®, Polaris®, Cepex®, Zodiac®, CTX Professional® e Gre®. Offriamo ai nostri clienti una vasta gamma di prodotti per le piscine residenziali e pubbliche e centri wellness; godiamo di una significativa presenza geografica, operando in più di 45 Stati.

Contiamo 5.500 dipendenti e investiamo forti risorse per promuovere l'innovazione in aree strategiche come l'efficienza energetica, l'automazione e la connettività applicata alla piscina.

Siamo guidati da valori chiari e lavoriamo ogni giorno con una semplice e chiara missione: **creare l'esperienza perfetta di piscina e wellness.**

Rimanendo focalizzati sulla nostra mission, creiamo valore per tutti i nostri stakeholder: clienti, possessori di piscine, investitori, dipendenti, fornitori e società.



MODELLI DI BUSINESS INTEGRATI



R+S+I

Eccellenza nell'innovazione con più di 200 ingegneri e più di 1.200 brevetti



Produzione

34 Centri di produzione flessibili e tecnologici nei Paesi chiave



Logistica

La logistica opera con l'obiettivo di assicurare consegne veloci e affidabili



Distribuzione

+140 filiali commerciali, che offrono supporto e formazione ai clienti in più di 45 Paesi



Ingegneria

Progettazioni riguardanti l'intero mondo dell'acqua

NUMERI SIGNIFICATIVI

5.500

Numero di dipendenti

+45

Numero di Paesi in cui siamo presenti

+140

Numero di filiali commerciali

34

Numero di centri di produzione

BRAND FORTEMENTE RICONOSCIUTI

Piscina residenziale e pubblica



UNA POTENZA GLOBALE

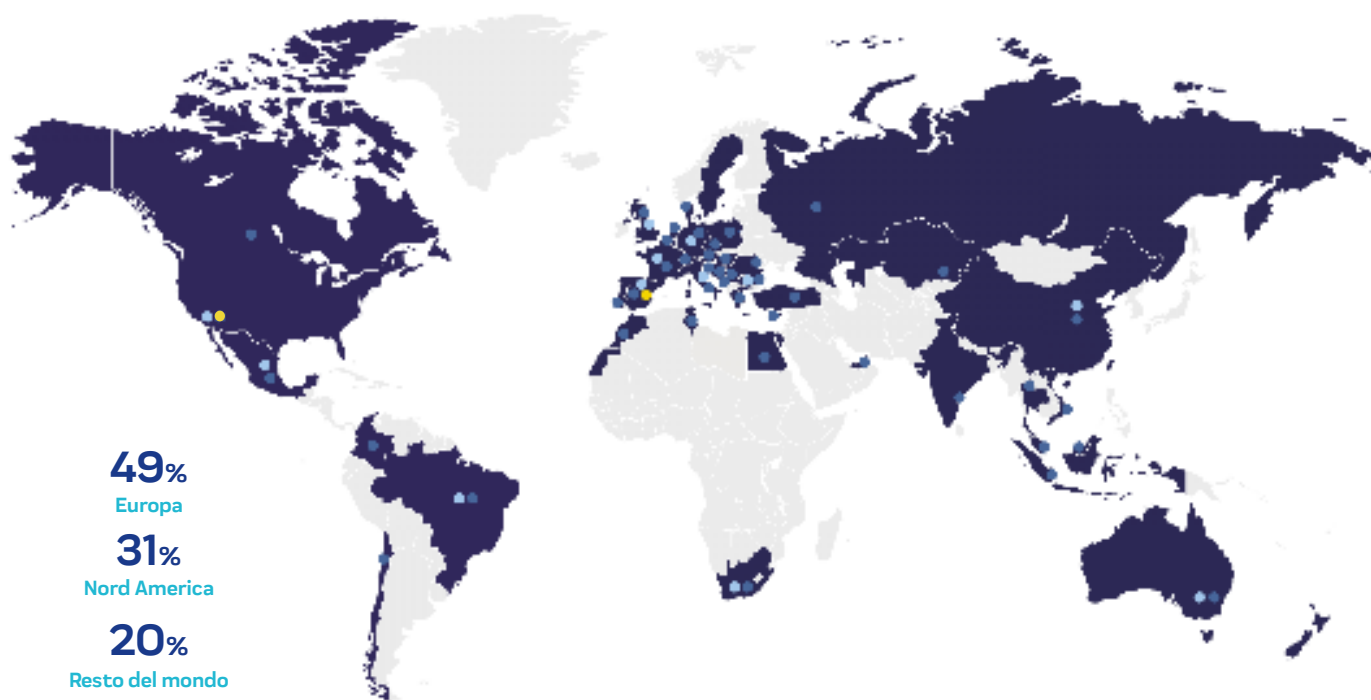

● Filiali

● Siti Produttivi

● Direzione

FLUIDRA COMMERCIALE ITALIA S.P.A.

L'organizzazione



FLUIDRA PRO | CENTER

I Fluidra Pro Center nascono negli anni 2000 con l'intento di creare un filo diretto con i propri clienti.

Il Fluidra Pro Center non vogliono essere solo i negozi professionali dove poter comprare prodotti per la costruzione di una piscina, bensì **il punto di riferimento per il professionista** all'interno del quale poter ricevere **consulenza tecnica e commerciale sui prodotti**, un supporto attento e mirato nell'acquisto, interagire ed aggiornarsi, partecipando alle **giornate formative e promozionali** organizzate nell'arco dell'intero anno.

I Fluidra Pro Center sono strategicamente posizionati **su tutto**

il **territorio nazionale** e, grazie alla vastità dei prodotti e i servizi disponibili al proprio interno, rispondono alle **esigenze commerciali e logistiche specifiche di ogni singolo cliente**. Il professionista della piscina potrà usufruire gratuitamente dei seguenti servizi: **toccare con mano i prodotti** prima dell'acquisto, visitare lo **showroom espositivo** di prodotti novità e/o wellness, **ricevere una consulenza tecnica**; essere aiutato **nel carico e scarico** del proprio ordine con il muletto; richiedere **preventivi dedicati**; approfittare di **promozioni speciali**; partecipare a **corsi e giornate dimostrative**.

Nei Fluidra Pro Center non siete semplici clienti, **siete uno di noi!**



Fluidra Pro Center LOMBARDIA
Via Trebocche, 7/D
25081 Bedizzole (BS)
Tel. **negozio** 030/6348998
Fax 030/6870571

Fluidra Pro Center PIEMONTE
Via Circonvallazione, 168
10026 SANTENA (TO)
Tel. 011/0243164

Fluidra Pro Center ADRIATICA
Via Cella Raibano 31
47843 Misano Adriatico (RN)
Tel. 0541/697483
Fax 0541/697485

Fluidra Pro Center TOSCANA
Via I Maggio, 28
Zona industriale Terrafino
50053 Empoli (FI)
Tel. 0571/1735038

Fluidra Pro Center LAZIO
Via Laurentina, km 23/000
00071 Pomezia (RM)
Tel. 06/9108470
Fax 06/9108978

Fluidra Pro Center PUGLIA
Via Baione sn
- Zona industriale 70043
Monopoli (BA)
Tel. 080/8498761
Fax 080/7985576

Fluidra Pro Center SARDEGNA
S.S. Ex 131 Km 7.650
09028 Sestu (CA)
Tel. 070/9166080
Fax 070/9166282

Fluidra Pro Center SICILIA
Strada provinciale 134
Contrada Rinaudo sn
95032 Belpasso (CT)
Tel. 095/7319159
Fax 095/7319148

FLUIDRA: LA FORMAZIONE

IN ACCORDO CON I PROTOCOLLI COVID-19, TUTTI I CORSI SARANNO TENUTI A DISTANZA

In un mondo competitivo dove è più importante farsi conoscere per la qualità del proprio servizio prima ancora del prezzo, **il professionista deve prima essere la figura di riferimento per tutto ciò che concerne la piscina e poi essere in grado di consegnare all'utente finale un lavoro eccellente.**

Al tempo stesso, però, è necessario che sappia anche **promuovere e valorizzare il proprio lavoro** affinché, tra la molteplicità delle offerte, la sua proposta risulti più professionale ed accattivante delle altre presenti sul mercato.

Il **piano formativo stilato da Fluidra** è pensato con la finalità di rendere il proprio cliente preparato, aggiornato, impeccabile sul piano tecnico, competitivo e comunicativo sul piano commerciale.

Attraverso il sito www.fluidraformazione.it, il professionista può visualizzare la totalità della proposta formativa ed **isciversi con un semplice click al corso d'interesse.**



Corsi tecnici/commerciali per imparare a **utilizzare e vendere i prodotti chimici.**



Corsi commerciali/tecnici per la **progettazione, la costruzione e la manutenzione** di **piscine residenziali, pubbliche, fontane e spazi wellness.**



Corsi commerciali e marketing che potenzino il contatto tra il professionista e il cliente e che migliorino la customer experience di quest'ultimo.



SCOPRI TUTTI I WEBINAR 2021



FLUIDRA PRO | ACADEMY

**LA PIATTAFORMA
FORMATIVA
ONLINE PER I
CLIENTI FLUIDRA**

www.proacademy.fluidra.com

Fluidra Pro Academy è la nuova piattaforma formativa per il professionista che permette di accedere in qualunque momento alle informazioni tecniche e commerciali dei prodotti, in modo facile e veloce.

I corsi sono sviluppati in tre livelli di apprendimento: base, medio ed esperto con test finali per verificare le competenze acquisite.

Come diventare un **PRO?**



1

Accedi al sito
proacademy.fluidra.com

2

Registrati

3

Inizia ad imparare



Accessibile
Sempre, ovunque



Veloce e facile
Eccellenti
conoscenze tecniche
a portata di mano



Livelli
Base, Intermedio,
Avanzato



Contenuti esclusivi
Impara ciò che nessun
altro conosce.
Per professionisti



L'ultimo aspetto
Sii il primo a scoprire
i nuovi lanci
di mercato



I NOSTRI SITI WEB

cepex.com/it

La nostra piattaforma web risponde alle esigenze del Professionista che vuole rimanere costantemente aggiornato sulle novità del mondo dell'irrigazione e della conduzione dei fluidi. All'interno del sito troverà la storia dell'azienda ed un blog sempre aggiornato sulle ultime novità, potrà usufruire della sezione **Download** per scaricare gratuitamente **materiale fotografico** e **cad** dei prodotti a marchio Cepex.

Inoltre **sul nostro sito web** potrà Consultare: **cataloghi**, **brochure**, **manuali ed istruzioni**, **resistenze chimiche**, **certificazioni**, **immagini** e una **libreria CAD completa**.

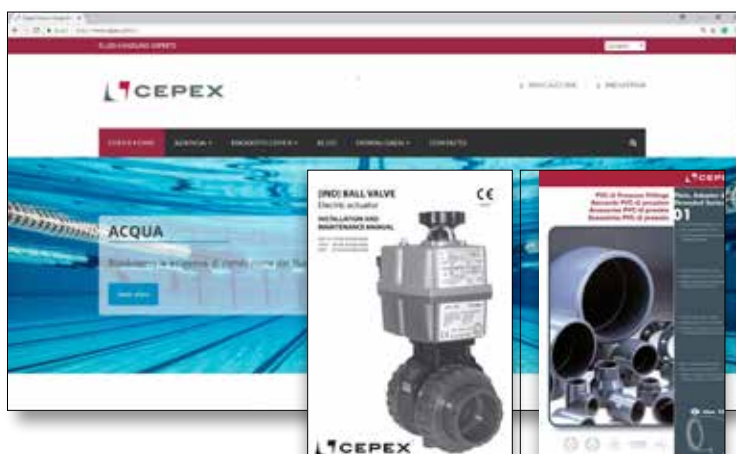

cepexindustrial.com

Il sito web dedicato alla nuova gamma di valvole della serie **CEPEX EXTREME**, dal quale il professionista potrà Consultare e scaricare i **cataloghi tecnici** e le **brochure di presentazione** della nuova gamma appositamente studiata per le **applicazioni industriali più esigenti** (impianti chimici, petrolchimici, siderurgici, miniere etc.).



cepexirrigation.com

Il sito web dedicato al mondo dell'irrigazione. All'interno troverà una sezione "Prodotti" dedicata ai **programmatori**, **gli irrigatori statici/dinamici**, **elettrovalvole**, **micro-irrigazione**, **filtrazione**, **pozzetti** e tanti altri accessori del brand, con **schede tecniche** e **cataloghi** facili da Consultare.



BENVENUTI NEL MONDO



Cepex risponde alle vostre necessità nella conduzione dei fluidi. Da oltre 30 anni è presente nel mercato sostenuta dalla piena soddisfazione dei suoi clienti. Grazie al suo appoggio e riconoscimento, Cepex si è confermata come una delle principali **fabbricanti europee di valvole e accessori in materiale plastico**, creando una propria rete di distribuzione proiettata verso un'espansione a livello mondiale.

Filosofia

Cepex concentra tutta la propria attività nell'offrire al mercato soluzioni efficaci, basandosi su **cinque principi** che danno come risultato un prodotto altamente competitivo e affidabile:

1- Ricerca

Per emergere nel mercato attuale, le imprese devono rispondere rapidamente alle sempre nuove necessità del cliente. Per questo **Cepex punta sull'innovazione e ricerca continua** appoggiandosi al costante lavoro del dipartimento R&S che sistematicamente analizza le differenti necessità del mercato per offrire prodotti che apportano soluzioni reali a necessità concrete.



2- Tecnologia

Il processo produttivo, dal concepimento del prodotto fino alla consegna al cliente, si sviluppa utilizzando la **tecnologia più avanzata per garantire la massima qualità** riducendo al minimo gli errori.

Per questo Cepex dispone di macchine ad iniezione, robot ed automatismi di ultima generazione ed un centro logistico automatizzato.



3- Qualità

Tutti i prodotti sono sottoposti a severi controlli, che includono una verifica del 100% di tutti i tipi di valvole. Per questo motivo Cepex ha potuto ottenere **numeroso certificazioni di qualità**, rilasciate da organismi di elevato prestigio mondiale.



OLTRE 30 ANNI DI ESPERIENZA

4- Servizio

Il servizio al cliente è la base del lavoro delle risorse umane e l'obiettivo di tutte le società che formano il gruppo. Il cliente ha a sua disposizione una collaudata **équipe tecnica e commerciale** per la risoluzione di qualsiasi dubbio o richiesta inerente il prodotto ed al suo funzionamento. Il continuo impegno per migliorare il servizio ha portato alla creazione nel 2003 di un centro logistico di 55.000 m² di superficie dotato dei sistemi più avanzati di stoccaggio e movimentazione automatica con capacità di 20.000 pallet.



5- Politica ambientale

Cepex è un'impresa rispettosa dell'ambiente le cui preoccupazioni sono particolarmente incentrate sui mezzi produttivi al fine di poter godere di un ambiente più gradevole. Per raggiungere i propri obiettivi, Cepex applica nelle imprese produttive **un Sistema di Gestione Ambientale basato sulla norma ISO 14001**, tramite il quale vengono monitorate tutte le attività e i processi che hanno un impatto sull'ambiente.



Applicazioni:

- Piscine



- Industria



- Irrigazione



IMBALLAGGIO

Imballaggio:

- Q(B) - Q : numero di pezzi per cartone
B : numero di pezzi per busta (raccordi)
o per cartone interno (valvole)
- Q(P) - numero di pezzi per pallet

- Per imballaggi fuori standard si indica il volume in m³ nella colonna PACK.
- Nuovo contenitore per grandi dimensioni: CP - 1,2 x 1 x 1.1m - 1,32 m³.

Packaging:

- Q(B) - Q: total quantity per box
B: quantity per bag (fittings)
or per internal box (valves)
- Q(P) - total quantity per pallet
- When non-standard boxes are used, volume (m³) is shown in the PACK column.
- The new carton box G has the measures of the old carton box F (600x400x680).
The new carton box F now has the following measures: 600x400x510.
- New carton box for big dimensions: CP - 1,2 x 1 x 1.1m - 1,32 m³.

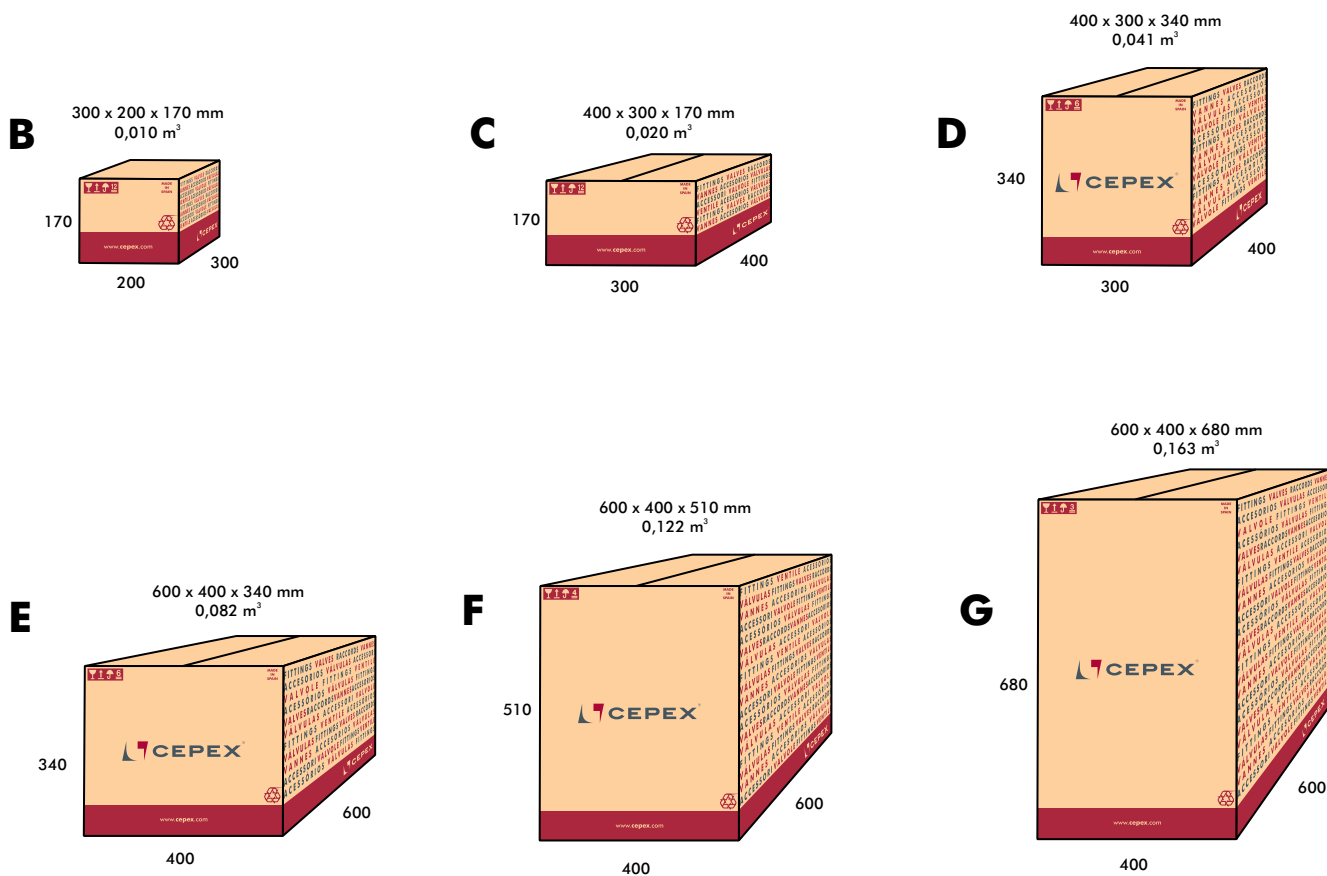

Valvole a farfalla Classic Series - Butterfly valves Classic Series

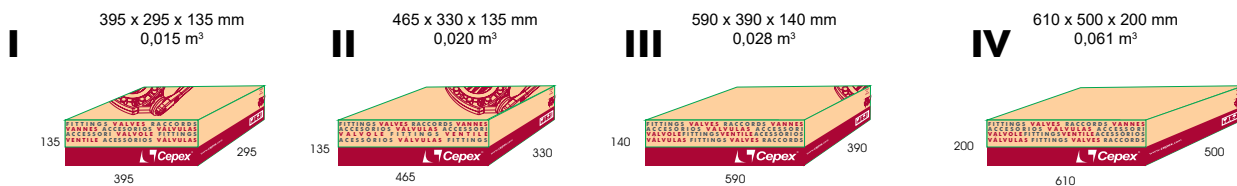

Valvole a farfalla Standard e Industrial Series - Butterfly valves Standard and Industrial Series

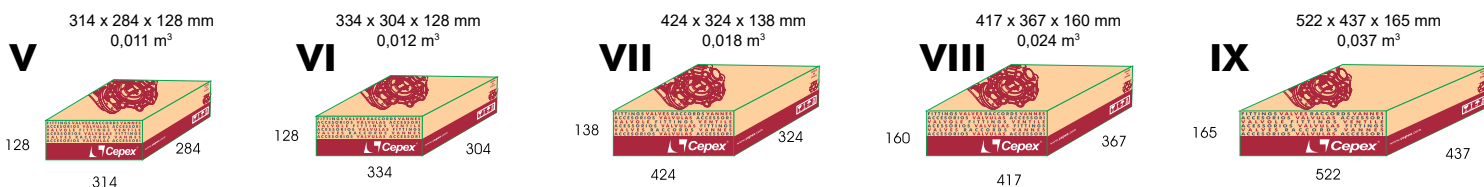

INDICE

ITALIANO	ENGLISH	PAGINA/PAGE	
ACCESSORI PVC-U PER PRESSIONE	PVC-U PRESSURE FITTINGS	17	Accessori PVC-U
ADESIVI / SOLVENTI	SOLVENT CEMENT / CLEANERS	41	
TUBO PRESSIONE PVC-U	PVC-U PRESSURE PIPE	43	
VALVOLE PER ACQUA PVC-U	PVC-U WATER VALVES	49	Valvole PVC-U
ACCESSORI PRESSIONE PVC-C	CPVC PRESSURE FITTINGS	85	Accessori PVC-C
ADESIVI/SOLVENTI PVC-C	SOLVENT CEMENT/CLEANERS CPVC	89	
TUBO PRESSIONE PVC-C	CPVC PRESSURE PIPE	89	
VALVOLE PER ACQUA PVC-C	CPVC WATER VALVES	93	Valvole PVC-C
VALVOLE INDUSTRIALI MANUALI CEPEX EXTREME	CEPEX EXTREME INDUSTRIAL MANUAL VALVES	105	Valvole Extreme
VALVOLE INDUSTRIALI ATTUATE CEPEX EXTREME	CEPEX EXTREME INDUSTRIAL ACTUATED VALVES	139	
ACCESSORI EVACUAZIONE	EVACUATION FITTINGS	188	Evacuazione
RICAMBI	SPARE PARTS	199	Ricambi

ACCESSORI PRESSIONE PVC-U

PVC-U PRESSURE FITTINGS

Accessori PVC-U

Valvole PVC-U

Accessori PVC-C

Valvole PVC-C

Valvole Extreme

Evacuazione

Ricambi

17 Gomiti e curve
Elbows and bends



31 Adattatori e manicotti nipplo
Nipples



38 Visori per liquidi
Sight glasses



19 Ti e croci
Tees and crosses



34 Bocchettoni
Unions



38 Accessori di riparazione
Fitting's repair



22 Manicotti e riduzioni
Sockets and reducers



37 Portagomma
Spigots



39 Accessori con guarnizione elastica
Rubber-ring joint fittings



25 Pinze fissaggio tubo
Pipe clips



38 Connessioni Victaulic®
Victaulic® coupling



40 Flussimetri
Flowmeters



26 Flange e collari
Flanges & bolts



30 Calotte
Caps



ADESIVI / SOLVENTI - SOLVENT CEMENT / CLEANER

41 Adesivi / solventi
Solvents cement/cleaners



TUBI PVC-U - PVC-U PIPE

43 Tubo semirigido PVC-U
PVC-U flexible hose



45 Tubo PVC rigido per pressione
PVC-U rigid pipe



44 Tubo flessibile spiralato FITT B-active
FITT B-ACTIVE: flexible hose



GOMITI E CURVE - ELBOWS AND BENDS

UP. 01. SF

C01 | ACP 010*



GOMITO 90°
incollaggio

90° ELBOW
solvent socket

SIZE	PN	REF.	PACK	kg	Q(B)	Q(P)	CODE	EUR
16	16	05 01 016	B	2,8	200	24.000	11655	1,35
20	16	05 01 020	B	2,5	140	16.800	01712	1,51
25	16	05 01 025	B	2,6	80	9.600	01713	1,76
32	16	05 01 032	C	5,1	90	5.400	01714	2,30
40	16	05 01 040	C	4,8	55	3.300	01715	3,84
50	16	05 01 050	D	8,9	60	1.800	01716	4,98
63	16	05 01 063	D	10,1	36	1.080	01717	7,41
75	16	05 01 075	D	8,6	21	630	01718	15,12
90	16	05 01 090	D	8,7	12	360	01719	20,45
110	16	05 01 110	E	17,8	14	210	01720	32,49
125	16	05 01 125	E	17,0	10	150	01721	61,96
140	16	05 01 140	E	10,8	5	75	01722	79,69
160	10	05 01 160	E	9,5	4	60	01723	118,75
200	10	05 01 200	F	13,5	3	30	01724	199,18
225	10	05 01 225	F	12,3	2	20	01725	287,79
250	10	05 01 250	F	19,6	2	20	01726	521,00
315	10	05 01 315	G	20,6	1	10	01727	1.080,60
400	5	05 01 400 *	CP	80,7	3	3	34807-IT	1.995,35

UP. 01. SFT

C01 | ACP 030



GOMITO 90° MISTO
incollaggio e filetto femmina

90° ELBOW
solvent socket x BSP female thread

SIZE	PN	REF.	PACK	kg	Q(B)	Q(P)	CODE	EUR
20 x 1/2"	10	05 01 420	B	2,6	130	15.600	01728	2,79
25 x 3/4"	10	05 01 425	B	2,4	70	8.400	01729	3,37
32 x 1"	10	05 01 432	B	2,1	30	3.600	01730	3,93
40 x 1 1/4"	10	05 01 440	C	4,2	50	3.000	01731	7,11
50 x 1 1/2"	10	05 01 450	C	5,2	28	1.680	01732	9,89
63 x 2"	10	05 01 463	C	5,4	16	960	01733	13,25
75 x 2 1/2"	10	05 01 475 *	C	3,7	9	540	22596	33,60
90 x 3"	10	05 01 490 *	C	4,2	6	360	22597	50,38
110 x 4"	10	05 01 510 *	C	3,1	3	180	22598	77,58

UP. 01. SFTR

C01 | ACP 030



GOMITO 90° MISTO RINFORZATO
incollaggio e filetto femmina

90° REINFORCED ELBOW
solvent socket x BSP female thread

SIZE	PN	REF.	PACK	kg	Q(B)	Q(P)	CODE	EUR
20 x 1/2"	16	05 01 820	B	2,9	130	15.600	01740	5,67
25 x 3/4"	16	05 01 825	B	2,7	70	8.400	01741	6,72
32 x 1"	16	05 01 832	B	2,3	30	3.600	01742	8,45
40 x 1 1/4"	16	05 01 840	B	2,5	20	2.400	01743	10,36
50 x 1 1/2"	16	05 01 850	C	5,4	28	1.680	01744	15,45
63 x 2"	16	05 01 863	C	5,1	16	960	01745	20,45

UP. 01. FT

C01 | ACP 040



GOMITO 90°
filetto femmina

90° ELBOW
BSP female thread

SIZE	PN	REF.	PACK	kg	Q(B)	Q(P)	CODE	EUR
1/2"	10	05 01 620	B	2,6	130	15.600	01734	2,40
3/4"	10	05 01 625	B	2,4	70	8.400	01735	2,98
1"	10	05 01 632	B	2,2	30	3.600	01736	3,46
1 1/4"	10	05 01 640	B	2,3	20	2.400	01737	5,09
1 1/2"	10	05 01 650	C	5,5	28	1.680	01738	7,78
2"	10	05 01 663	C	5,6	16	960	01739	11,32
2 1/2"	10	05 01 675 *	C	4,0	9	540	22587	35,89
3"	10	05 01 690 *	C	4,6	6	360	22588	53,21
4"	10	05 01 710 *	C	3,1	3	180	22589	87,36

UP. 29. SFG

C01 | ACP 010



GOMITO 90° RIDOTTO
incollaggio

90° REDUCING ELBOW
solvent socket

SIZE	PN	REF.	PACK	kg	Q(B)	Q(P)	CODE	EUR
50 x 50 - 40	16	05 29 050	D	11,0	60	1.800	02237	7,30
63 x 63 - 50	16	05 29 063	D	9,2	32	960	02238	11,13

UP. 29. SMT

C01 | ACP 030



GOMITO 90°
incollaggio e filetto maschio

90° ELBOW
solvent socket x BSP male thread

SIZE	PN	REF.	PACK	kg	Q(B)	Q(P)	CODE	EUR
50 x 1 1/2"	10	05 29 450	D	9,9	80	2.400	02239	8,54
63 x 2"	10	05 29 463	D	11,0	42	1.260	02240	12,58

UP. 02. SF

C01 | ACP 010*

GOMITO 45°
 incollaggio

45° ELBOW
 solvent socket

SIZE	PN	REF.	PACK	kg	Q(B)	Q(P)	CODE	EUR
16	16	05 02 016	B	1,8	200	24.000	16307	2,69
20	16	05 02 020	B	2,1	140	16.800	01746	2,59
25	16	05 02 025	B	2,4	80	9.600	01747	2,79
32	16	05 02 032	C	4,9	100	6.000	01748	3,84
40	16	05 02 040	C	4,5	60	3.600	01749	4,61
50	16	05 02 050	D	6,7	80	2.400	01750	5,67
63	16	05 02 063	D	9,0	45	1.350	01751	8,54
75	16	05 02 075	D	8,2	25	750	01752	15,65
90	16	05 02 090	D	8,3	15	450	01753	21,16
110	16	05 02 110	E	13,8	16	240	01754	45,70
125	16	05 02 125	E	16,3	12	180	01755	55,59
140	16	05 02 140	G	13,3	8	80	01756	79,20
160	10	05 02 160	E	9,1	5	75	01757	95,11
200	10	05 02 200	F	13,2	4	40	01758	189,79
225	10	05 02 225	E	9,2	2	30	01759	252,09
250	10	05 02 250	F	14,9	2	20	01760	434,18
315	10	05 02 315	F	15,0	1	10	01761	990,50
400	5	05 02 400 *	CP	84,0	4	4	34808-IT	1.675,15

UP. 02. SFT

C01 | ACP 030

GOMITO 45° MISTO
 incollaggio e filetto femmina

45° ELBOW
 solvent socket x BSP female thread

SIZE	PN	REF.	PACK	kg	Q(B)	Q(P)	CODE	EUR
20 x 1/2"	10	05 02 420	B	2,3	140	16.800	01762	3,93
25 x 3/4"	10	05 02 425	B	2,4	80	9.600	01763	4,22
32 x 1"	10	05 02 432	B	2,1	40	4.800	01764	5,01
40 x 1 1/4"	10	05 02 440	B	2,0	20	2.400	01765	7,00
50 x 1 1/2"	10	05 02 450	C	5,3	35	2.100	01766	8,93
63 x 2"	10	05 02 463	C	5,2	18	1.080	01767	13,25
75 x 2 1/2"	10	05 02 475 *	C	3,1	10	600	22599	43,16
90 x 3"	10	05 02 490 *	C	3,1	6	360	22600	55,63
110 x 4"	10	05 02 510 *	C	3,6	4	240	22601	99,00

UP. 02. SFTR

C01 | ACP 030

GOMITO 45° MISTO RINFORZATO
 incollaggio e filetto femmina

45° REINFORCED ELBOW
 solvent socket x BSP female thread

SIZE	PN	REF.	PACK	kg	Q(B)	Q(P)	CODE	EUR
20 x 1/2"	16	05 02 820	B	2,6	140	16.800	01774	7,20
25 x 3/4"	16	05 02 825	B	2,7	80	9.600	01775	7,68
32 x 1"	16	05 02 832	B	2,2	40	4.800	01776	10,08
40 x 1 1/4"	16	05 02 840	B	2,1	20	2.400	01777	11,81
50 x 1 1/2"	16	05 02 850	C	5,6	35	2.100	01778	17,00
63 x 2"	16	05 02 863	C	5,5	18	1.080	01779	22,56

UP. 02. FT

C01 | ACP 040

GOMITO 45°
 filetto femmina

45° ELBOW
 BSP female thread

SIZE	PN	REF.	PACK	kg	Q(B)	Q(P)	CODE	EUR
1/2"	10	05 02 620	B	2,3	140	16.800	01768	4,70
3/4"	10	05 02 625	B	2,4	80	9.600	01769	5,28
1"	10	05 02 632	B	2,0	40	4.800	01770	6,72
1 1/4"	10	05 02 640	B	1,7	20	2.400	01771	9,02
1 1/2"	10	05 02 650	C	5,5	35	2.100	01772	11,81
2"	10	05 02 663	C	5,7	18	1.080	01773	17,00
2 1/2"	10	05 02 675 *	C	3,3	10	600	22590	54,46
3"	10	05 02 690 *	C	3,5	6	360	22591	71,32
4"	10	05 02 710 *	C	3,5	4	240	22592	135,73

UP. 30. SFG

C01 | ACP 010

GOMITO 45° RIDOTTO
 incollaggio

45° REDUCING ELBOW
 solvent socket

SIZE	PN	REF.	PACK	kg	Q(B)	Q(P)	CODE	EUR
50 x 50 - 40	16	05 30 050	D	10,7	90	2.700	02241	7,87
63 x 63 - 50	16	05 30 063	D	10,3	50	1.500	02242	11,91

UP. 35. SF

C01 | ACP 025

CURVA 45°
 incollaggio

45° BEND
 solvent socket

SIZE	PN	REF.	PACK	kg	Q(B)	Q(P)	CODE	EUR
315	4	05 35 315 *	CP	157,0	6	6	05348-IT	1.249,76
400	4	05 35 400 *	CP	84,0	3	3	05349-IT	1.888,28

UP. 08. SF

C01 | ACP 010*



CURVA 90°
incollaggio

90° BEND
solvent socket

SIZE	PN	REF.	PACK	kg	Q(B)	Q(P)	CODE	EUR
20	16	05 08 020	B	2,0	60	7.200	01967	5,85
25	16	05 08 025	B	2,1	40	4.800	01968	6,91
32	16	05 08 032	B	2,3	24	2.880	01969	8,45
40	16	05 08 040	C	4,2	25	1.500	01970	11,62
50	16	05 08 050	D	8,5	30	900	01971	16,41
63	16	05 08 063	D	7,7	15	450	01972	21,70
75	16	05 08 075	D	6,6	8	240	01973	45,89
90	16	05 08 090	D	5,6	4	120	05331	93,06
110	16	05 08 110 *	E	11,3	4	60	05332	165,70
125	10	05 08 125 *	E	15,2	5	75	05333	328,38
140	10	05 08 140 *	E	12,3	4	60	05334	346,01
160	10	05 08 160 *	F	18,6	4	40	05335	396,69
200	4	05 08 200 *	F	6,9	1	10	05336	907,12
225	4	05 08 225 *	G	10,2	1	10	05337	1.003,09
250	4	05 08 250 *	G	11,7	1	10	05338	898,69
315	4	05 08 315 *	CP	74,8	3	3	05339	1.854,48
400	4	05 08 400 *	CP	82,0	2	2	05340	2.472,64

TI E CROCI - TEES AND CROSSES

UP. 03. SF

C01 | ACP 010*



TI 90°
incollaggio

90° TEE
solvent socket

SIZE	PN	REF.	PACK	kg	Q(B)	Q(P)	CODE	EUR
16	16	05 03 016	B	2,2	120	14.400	16308	1,63
20	16	05 03 020	B	2,3	100	12.000	01780	1,63
25	16	05 03 025	B	1,9	50	6.000	01781	2,30
32	16	05 03 032	C	4,2	60	3.600	01782	2,79
40	16	05 03 040	C	4,7	40	2.400	01783	4,61
50	16	05 03 050	D	11,1	48	1.440	01784	6,43
63	16	05 03 063	D	10,1	24	720	01785	9,57
75	16	05 03 075	D	8,4	15	450	01786	17,92
90	16	05 03 090	D	7,4	8	240	01787	27,08
110	16	05 03 110	E	16,4	10	150	01788	42,50
125	16	05 03 125	E	16,2	7	105	01789	86,98
140	16	05 03 140	E	11,1	4	60	01790	117,02
160	10	05 03 160	E	12,2	3	45	01791	140,35
200	10	05 03 200	F	13,4	2	20	01792	252,80
225	10	05 03 225	F	18,1	2	20	01793	353,37
250	10	05 03 250	F	13,0	1	10	01794	607,84
315	10	05 03 315	G	25,7	1	10	01795	1.167,43
400	4	05 03 400 *	CP	124,0	3	3	05328-IT	3.024,33

UP. 03. SFT

C01 | ACP 030



TI 90° MISTA
incollaggio e filetto femmina

90° TEE
solvent socket x BSP female thread

SIZE	PN	REF.	PACK	kg	Q(B)	Q(P)	CODE	EUR
20 x 1/2"	10	05 03 420	B	2,7	100	12.000	01796	2,98
25 x 3/4"	10	05 03 425	B	2,3	50	6.000	01797	3,54
32 x 1"	10	05 03 432	B	2,5	30	3.600	01798	4,52
40 x 1 1/4"	10	05 03 440	B	2,9	19	2.280	01799	6,72
50 x 1 1/2"	10	05 03 450	C	5,0	21	1.260	01800	9,70
63 x 2"	10	05 03 463	C	5,3	12	720	01801	16,41
75 x 2 1/2"	10	05 03 475 *	C	3,1	6	360	22602	38,74
90 x 3"	10	05 03 490 *	C	2,6	3	180	22603	58,05
110 x 4"	10	05 03 510 *	C	2,9	2	120	22604	95,65

UP. 03. SFTR

C01 | ACP 030



TI 90° MISTA RINFORZATA
incollaggio e filetto femmina

90° REINFORCED TEE
solvent socket x BSP female thread

SIZE	PN	REF.	PACK	kg	Q(B)	Q(P)	CODE	EUR
20 x 1/2"	16	05 03 820	B	2,9	100	12.000	01808	7,00
25 x 3/4"	16	05 03 825	B	2,6	50	6.000	01809	7,87
32 x 1"	16	05 03 832	B	2,6	30	3.600	01810	9,98
40 x 1 1/4"	16	05 03 840	B	2,4	19	2.280	01811	12,19
50 x 1 1/2"	16	05 03 850	C	4,7	21	1.260	01812	18,43
63 x 2"	16	05 03 863	C	4,8	12	720	01813	24,96

UP. 03. FT

C01 | ACP 040

TI 90°
filetto femmina

90° TEE
BSP female thread

SIZE	PN	REF.	PACK	kg	Q(B)	Q(P)	CODE	EUR
1/2"	10	05 03 620	B	3,3	100	12.000	01802	2,98
3/4"	10	05 03 625	B	2,2	50	6.000	01803	3,93
1"	10	05 03 632	B	2,5	30	3.600	01804	4,52
1 1/4"	10	05 03 640	B	2,9	19	2.280	01805	6,14
1 1/2"	10	05 03 650	C	5,8	21	1.260	01806	9,70
2"	10	05 03 663	C	6,0	12	720	01807	13,25
2 1/2"	10	05 03 675 *	C	3,4	6	360	22593	44,65
3"	10	05 03 690 *	C	2,9	3	180	22594	59,19
4"	10	05 03 710 *	C	2,9	2	120	22595	108,33

UP. 04. SFG

C01 | ACP 010*

TI 90° RIDOTTA
incollaggio

90° REDUCING TEE
solvent socket

SIZE	PN	REF.	PACK	kg	Q(B)	Q(P)	CODE	EUR
25 x 20	16	05 04 025	B	2,1	50	6.000	01814	2,40
32 x 25	16	05 04 032	C	4,3	60	3.600	01815	2,98
32 x 20	16	05 04 033	C	4,2	60	3.600	01816	2,98
40 x 32	16	05 04 040	C	5,1	46	2.760	01817	4,70
40 x 25	16	05 04 041	C	3,9	40	2.400	01818	4,70
40 x 20	16	05 04 042	C	5,6	48	2.880	01819	4,70
50 x 40	16	05 04 050	D	9,7	48	1.440	01820	6,82
50 x 32	16	05 04 051	D	9,7	48	1.440	01821	6,82
50 x 25	16	05 04 052	D	10,7	54	1.620	01822	6,82
50 x 20	16	05 04 053	D	11,2	56	1.680	01823	6,82
63 x 50	16	05 04 063	D	9,5	27	810	01824	10,27
63 x 40	16	05 04 064	D	10,0	28	840	01825	10,27
63 x 32	16	05 04 065	D	10,7	30	900	01826	10,27
63 x 25	16	05 04 066	D	10,5	30	900	01827	10,27
63 x 20	16	05 04 067	D	10,4	30	900	01828	10,27
75 x 63	16	05 04 075	D	8,8	16	480	01829	18,82
75 x 50	16	05 04 076	D	10,1	18	540	01830	18,82
75 x 40	16	05 04 077	D	10,0	18	540	01831	18,82
75 x 32	16	05 04 078	D	9,8	18	540	01832	18,82
90 x 75	16	05 04 090	D	8,3	9	270	01833	27,55
90 x 63	16	05 04 091	D	8,5	9	270	01834	27,55
90 x 50	16	05 04 092	D	8,8	9	270	01835	27,55
90 x 40	16	05 04 093	D	8,6	9	270	01836	27,55
110 x 90	16	05 04 110	E	15,9	11	165	01837	43,11
110 x 75	16	05 04 111	E	16,7	12	180	01838	43,11
110 x 63	16	05 04 112	E	16,2	12	180	01839	43,11
110 x 50	16	05 04 113	E	16,2	12	180	01840	43,11
125 x 110	16	05 04 125	E	15,0	7	105	01841	107,91
125 x 90	16	05 04 126	E	16,7	8	120	01842	107,91
125 x 75	16	05 04 127	E	15,7	8	120	01843	107,91
125 x 63	16	05 04 128	E	15,9	8	120	01844	107,91
140 x 125	16	05 04 140	E	12,9	5	75	01845	144,48
140 x 110	16	05 04 141	E	14,7	6	90	01846	144,48
140 x 90	16	05 04 142	E	14,2	6	90	01847	144,48
140 x 75	16	05 04 143	E	13,9	6	90	01848	144,48
160 x 140	10	05 04 160	E	11,2	3	45	07688	162,81
160 x 125	10	05 04 161	E	10,9	3	45	07689	162,81
160 x 110	10	05 04 162	E	10,7	3	45	07690	160,85
160 x 90	10	05 04 163	E	10,4	3	45	07691	160,85

Accessori PVC-U

Valvole PVC-U

Accessori PVC-C

Valvole PVC-C

Valvole Extreme

Evacuazione

Ricambi

UP. 04. SFTG

C01 | ACP 030

**TI 90° MISTA RIDOTTA**

incollaggio e filetto femmina

90° REDUCING TEE

solvent socket x BSP female thread

SIZE	PN	REF.	PACK	kg	Q(B)	Q(P)	CODE	EUR
25 x 1/2"	10	05 04 425	B	2,1	50	6.000	01849	4,22
32 x 3/4"	10	05 04 432	B	2,2	30	3.600	01850	5,28
32 x 1/2"	10	05 04 433	B	2,1	30	3.600	01851	5,28
40 x 1"	10	05 04 440	C	4,8	40	2.400	01852	7,87
40 x 3/4"	10	05 04 441	C	4,9	40	2.400	01853	7,87
40 x 1/2"	10	05 04 442	C	4,6	40	2.400	01854	7,87
50 x 1 1/4"	10	05 04 450	C	4,8	24	1.440	01855	11,04
50 x 1"	10	05 04 451	C	5,0	24	1.440	01856	11,04
50 x 3/4"	10	05 04 452	C	4,9	24	1.440	01857	11,04
50 x 1/2"	10	05 04 453	C	4,9	24	1.440	01858	11,04
63 x 1 1/2"	10	05 04 463	C	4,0	13	780	01859	16,13
63 x 1 1/4"	10	05 04 464	C	5,1	14	840	01860	16,13
63 x 1"	10	05 04 465	C	5,4	15	900	01861	16,13
63 x 3/4"	10	05 04 466	C	5,3	15	900	01862	16,13
63 x 1/2"	10	05 04 467	C	5,3	15	900	01863	16,13
75 x 2"	10	05 04 475	C	3,6	6	360	01864	27,27
75 x 1 1/2"	10	05 04 476	C	3,5	6	360	01865	27,27
75 x 1 1/4"	10	05 04 477	C	3,4	6	360	01866	27,27
75 x 1"	10	05 04 478	C	3,4	6	360	01867	27,27
90 x 2 1/2"	10	05 04 490	C	2,9	3	180	01868	46,09
90 x 2"	10	05 04 491	C	3,0	3	180	01869	46,09
90 x 1 1/2"	10	05 04 492	C	2,9	3	180	01870	46,09
90 x 1 1/4"	10	05 04 493	C	2,8	3	180	01871	46,09

UP. 36. SF

C01 | ACP 010

**TI 45°**

incollaggio

45° TEE

solvent socket

SIZE	PN	REF.	PACK	kg	Q(B)	Q(P)	CODE	EUR
20	16	05 36 020 *	B	2,3	70	8.400	22583	7,36
25	16	05 36 025 *	B	2,3	40	4.800	22584	8,51
32	16	05 36 032 *	B	2,4	24	2.880	22585	9,52
40	16	05 36 040 *	C	5,2	30	1.800	22586	12,99
50	10	05 36 050	D	8,7	32	960	20155	15,39
63	10	05 36 063	D	8,6	18	540	20156	21,85
75	10	05 36 075 *	D	7,5	11	330	32804	74,98
90	10	05 36 090 *	D	6,6	6	180	32805	123,25
110	10	05 36 110 *	E	13,6	7	105	32806	249,63

UP. 28. SF

C01 | ACP 010

**CROCE**

incollaggio

CROSS

solvent socket

SIZE	PN	REF.	PACK	kg	Q(B)	Q(P)	CODE	EUR
20	16	05 28 020	B	2,1	60	7.200	20143	3,39
25	16	05 28 025	B	2,2	40	4.800	20144	4,36
32	16	05 28 032	B	2,0	20	2.400	20145	6,29
40	16	05 28 040	C	4,9	30	1.800	20146	10,35
50	16	05 28 050	D	9,0	32	960	02235	14,50
63	16	05 28 063	D	8,1	16	480	02236	19,30
75	16	05 28 075 *	D	6,8	12	360	27958	77,24
90	16	05 28 090 *	E	10,8	12	180	22581	98,94
110	16	05 28 110 *	E	9,3	6	90	22582	157,43

MANICOTTI E RIDUZIONI - SOCKETS AND REDUCERS
UP. 05. SF

C01 | ACP 010*

MANICOTTO
 incollaggio

SOCKET
 solvent socket

SIZE	PN	REF.	PACK	kg	Q(B)	Q(P)	CODE	EUR
16	16	05 05 016	B	1,5	200	24.000	16309	1,23
20	16	05 05 020	B	2,6	200	24.000	01872	1,28
25	16	05 05 025	B	2,5	120	14.400	01873	1,38
32	16	05 05 032	C	5,3	160	9.600	01874	1,54
40	16	05 05 040	C	4,6	80	4.800	01875	2,33
50	16	05 05 050	C	4,9	56	3.360	01876	2,94
63	16	05 05 063	C	5,1	34	2.040	01877	4,36
75	16	05 05 075	C	3,5	14	840	01878	9,50
90	16	05 05 090	D	7,6	18	540	01879	15,93
110	16	05 05 110	D	8,5	12	360	01880	22,30
125	16	05 05 125	E	15,7	16	240	01881	35,14
140	16	05 05 140	E	15,4	12	180	01882	45,70
160	10	05 05 160	E	7,9	6	90	01883	55,87
200	10	05 05 200	E	7,9	3	45	01884	134,11
225	10	05 05 225	F	12,8	4	40	01885	150,04
250	10	05 05 250	E	9,6	2	30	01886	328,04
315	10	05 05 315	F	9,9	1	10	01887	539,83
400	6	05 05 400 *	F	14,8	1	8	05329-IT	799,20

UP. 05. SFT

C01 | ACP 030

MANICOTTO MISTO
 incollaggio e filetto femmina

ADAPTOR SOCKET
 solvent socket x BSP female thread

SIZE	PN	REF.	PACK	kg	Q(B)	Q(P)	CODE	EUR
16 x 3/4"	10	05 05 416	B	2,2	200	24.000	01888	2,50
20 x 1/2"	10	05 05 420	B	2,8	180	21.600	01889	2,50
25 x 3/4"	10	05 05 425	B	2,5	100	12.000	01890	2,69
32 x 1"	10	05 05 432	C	5,2	120	7.200	01891	3,02
40 x 1 1/4"	10	05 05 440	C	4,6	60	3.600	01892	4,32
50 x 1 1/2"	10	05 05 450	C	6,5	56	3.360	01893	6,82
63 x 2"	10	05 05 463	C	6,4	28	1.680	01894	8,93
75 x 2 1/2"	10	05 05 475	C	3,9	14	840	01895	25,34
90 x 3"	10	05 05 490	D	10,9	24	720	01896	28,03
110 x 4"	10	05 05 510	D	8,2	10	300	01897	40,02

UP. 05. SFTR

C01 | ACP 030

MANICOTTO MISTO RINFORZATO
 incollaggio e filetto femmina

ADAPTOR REINFORCED SOCKET
 solvent socket x BSP female thread

SIZE	PN	REF.	PACK	kg	Q(B)	Q(P)	CODE	EUR
20 x 1/2"	16	05 05 820	B	3,3	180	21.600	01908	6,52
25 x 3/4"	16	05 05 825	B	2,9	100	12.000	01909	7,00
32 x 1"	16	05 05 832	B	2,9	60	7.200	01910	9,02
40 x 1 1/4"	16	05 05 840	B	2,5	30	3.600	01911	10,27
50 x 1 1/2"	16	05 05 850	C	7,2	56	3.360	01912	14,77
63 x 2"	16	05 05 863	C	6,9	28	1.680	01913	17,86

UP. 05. FT

C01 | ACP 040

MANICOTTO
 filetto femmina

THREADED SOCKET
 BSP female thread

SIZE	PN	REF.	PACK	kg	Q(B)	Q(P)	CODE	EUR
3/8"	10	05 05 616	B	2,2	200	24.000	01898	2,50
1/2"	10	05 05 620	B	2,7	180	21.600	01899	2,50
3/4"	10	05 05 625	B	2,5	100	12.000	01900	2,69
1"	10	05 05 632	C	5,1	120	7.200	01901	3,37
1 1/4"	10	05 05 640	C	4,6	60	3.600	01902	4,32
1 1/2"	10	05 05 650	C	7,2	56	3.360	01903	6,52
2"	10	05 05 663	C	7,2	28	1.680	01904	8,06
2 1/2"	10	05 05 675	C	4,1	14	840	01905	24,38
3"	10	05 05 690	C	4,0	8	480	01906	28,99
4"	10	05 05 710	C	4,0	5	300	01907	41,57

UP. 27. SF. MBS

C01 | ACP 030

**MANICOTTO**incollaggio metrico
x BS**TRANSITION SOCKET**

solvent socket metric x British Standard (BS)

SIZE	PN	REF.	PACK	kg	Q(B)	Q(P)	CODE	EUR
20 x ½"	16	05 27 901	B	2,4	200	24.000	07229	1,51
25 x ¾"	16	05 27 902	B	2,3	120	14.400	07230	1,86
32 x 1"	16	05 27 903	C	5,0	160	9.600	07231	2,09
40 x 1¼"	16	05 27 904	C	4,0	80	4.800	07232	3,17
50 x 1½"	16	05 27 905	C	5,2	56	3.360	07233	4,00
63 x 2"	16	05 27 906	C	5,9	34	2.040	07234	5,97
90 x 3"	10	05 27 908	D	10,9	24	720	07236	15,86
110 x 4"	10	05 27 910	D	6,8	12	360	07237	26,27

UP. 27. SF. MMA

C01 | ACP 030

**MANICOTTO**

incollaggio metrico x ASTM

TRANSITION SOCKET

solvent socket metric x American size (ASTM)

SIZE	PN	REF.	PACK	kg	Q(B)	Q(P)	CODE	EUR
20 x ½"	16	05 27 901 MA	B	2,6	200	24.000	60257	3,61
25 x ¾"	16	05 27 902 MA	B	2,4	120	14.400	64467	3,86
32 x 1"	16	05 27 903 MA	C	3,8	120	7.200	64468	4,73
40 x 1¼"	16	05 27 904 MA	C	4,2	80	4.800	64496	5,59
50 x 1½"	16	05 27 905 MA	C	6,3	56	3.360	64497	7,42
63 x 2"	16	05 27 906 MA	C	6,4	28	1.680	64498	10,98
75 x 2½"	10	05 27 907 MA	C	3,9	14	840	64499	19,68
90 x 3"	10	05 27 908 MA	D	10,9	24	720	64500	23,06
110 x 4"	10	05 27 910 MA	D	6,9	12	360	64501	37,96

UP. 06. SMF

C01 | ACP 010*

**BUSSOLA RIDUZIONE**

incollaggio

REDUCING BUSH

solvent socket

SIZE	PN	REF.	PACK	kg	Q(B)	Q(P)	CODE	EUR
20 x 16	16	05 06 020	B	0,5	200	24.000	01914	1,09
25 x 20	16	05 06 025	B	0,9	200	24.000	01915	1,21
32 x 25	16	05 06 032	B	2,0	200	24.000	01916	1,38
32 x 20	16	05 06 033	B	2,5	200	24.000	01917	1,38
40 x 32	16	05 06 040	B	2,0	120	14.400	01918	1,76
40 x 25	16	05 06 041	B	2,8	120	14.400	01919	1,76
40 x 20	16	05 06 042	B	2,8	120	14.400	01920	1,76
50 x 40	16	05 06 050	B	1,9	60	7.200	01921	2,30
50 x 32	16	05 06 051	B	2,4	60	7.200	01922	2,30
50 x 25	16	05 06 052	B	2,8	60	7.200	01923	2,30
50 x 20	16	05 06 053	B	2,7	60	7.200	01924	2,30
63 x 50	16	05 06 063	B	3,0	48	5.760	01925	3,27
63 x 40	16	05 06 064	B	3,1	40	4.800	01926	3,37
63 x 32	16	05 06 065	B	3,1	40	4.800	01927	3,37
75 x 63	16	05 06 075	B	2,2	28	3.360	01928	5,00
75 x 50	16	05 06 076	B	3,3	28	3.360	18685	6,34
75 x 40	16	05 06 077	B	3,4	28	3.360	18686	6,34
90 x 75	16	05 06 090	C	5,1	36	2.160	01929	7,87
90 x 63	16	05 06 091	C	6,0	36	2.160	18687	10,36
90 x 50	16	05 06 092	C	6,4	36	2.160	18688	10,36
110 x 90	16	05 06 110	C	4,3	16	960	01930	12,74
110 x 75	16	05 06 111	C	5,1	16	960	18689	19,48
110 x 63	16	05 06 112	C	5,0	16	960	18690	19,48
125 x 110	16	05 06 125	D	6,6	24	720	01931	22,18
125 x 90	16	05 06 126	C	5,1	12	720	18691	25,44
125 x 75	16	05 06 127	C	5,0	12	720	20142	25,44
140 x 125	16	05 06 140	D	6,6	20	600	01932	32,45
140 x 110	16	05 06 141	C	4,6	10	600	18692	34,85
160 x 140	10	05 06 160	D	6,8	12	360	01933	35,14
160 x 125	10	05 06 161	C	5,6	6	360	62136	42,27
160 x 110	10	05 06 162	C	4,5	6	360	18693	45,79
200 x 180	10	05 06 199	D	5,4	6	180	01934	52,02
200 x 160	10	05 06 200	D	7,6	6	180	01935	52,02
225 x 200	10	05 06 225	E	9,8	7	105	01936	86,98
225 x 160	10	05 06 226	E	15,4	7	105	01937	86,98
250 x 225	10	05 06 250	E	10,0	6	90	01938	185,47
250 x 200	10	05 06 251	E	15,4	6	90	01939	185,47
315 x 280	6	05 06 315	E	10,8	3	45	10093	433,07
315 x 250	6	05 06 316 *	E	15,1	3	45	01940	352,66
315 x 225	6	05 06 317 *	E	15,8	3	45	01941	352,66
400 x 315	6	05 06 400 *	F	10,3	1	10	05330-IT	530,23

UP. 09. SMF

C01 | ACP 010*

RIDUZIONE CONICA

incollaggio

CONICAL REDUCER

solvent socket

SIZE	PN	REF.	PACK	kg	Q(B)	Q(P)	CODE	EUR
32 - 25 x 25	16	05 09 032	B	2,2	100	12.000	01974	1,89
32 - 25 x 20	16	05 09 033	B	2,3	120	14.400	01975	2,40
40 - 32 x 32	16	05 09 040	B	1,7	50	6.000	01976	2,59
40 - 32 x 25	16	05 09 041	B	2,1	60	7.200	01977	2,59
40 - 32 x 20	16	05 09 042	B	2,2	80	9.600	01978	2,59
50 - 40 x 40	16	05 09 050	B	2,0	30	3.600	01979	3,84
50 - 40 x 32	16	05 09 051	C	3,6	60	3.600	01980	3,84
50 - 40 x 25	16	05 09 052	B	2,1	40	4.800	01981	3,84
50 - 40 x 20	16	05 09 053	B	2,3	50	6.000	01982	3,84
63 - 50 x 50	16	05 09 063	B	2,5	20	2.400	01983	4,45
63 - 50 x 40	16	05 09 064	C	5,2	46	2.760	01984	4,45
63 - 50 x 32	16	05 09 065	B	2,5	30	3.600	01985	4,45
63 - 50 x 25	16	05 09 066	B	2,5	30	3.600	01986	4,45
63 - 50 x 20	16	05 09 067	B	2,7	30	3.600	01987	4,45
75 - 63 x 63	16	05 09 075	C	4,4	26	1.560	01988	6,62
75 - 63 x 50	16	05 09 076	C	5,7	40	2.400	01989	6,62
75 - 63 x 40	16	05 09 077	C	5,2	40	2.400	01990	6,62
75 - 63 x 32	16	05 09 078	C	4,7	40	2.400	01991	6,62
90 - 75 x 75	16	05 09 090	C	3,6	12	720	01992	12,58
90 - 75 x 63	16	05 09 091	D	9,0	34	1.020	01993	12,58
90 - 75 x 50	16	05 09 092	D	10,6	48	1.440	01994	12,58
90 - 75 x 40	16	05 09 093	C	5,0	24	1.440	01995	12,58
110 - 90 x 90	16	05 09 110	D	8,7	16	480	01996	20,93
110 - 90 x 75	16	05 09 111	D	8,8	18	540	01997	20,93
110 - 90 x 63	16	05 09 112	D	11,7	27	810	01998	20,93
110 - 90 x 50	16	05 09 113	D	11,0	27	810	01999	20,93
125 - 110 x 90	16	05 09 126	D	9,9	18	540	02000	31,29
125 - 110 x 75	16	05 09 127	D	9,5	18	540	02001	31,29
125 - 110 x 63	16	05 09 128	D	8,2	20	600	02002	31,29
140 - 125 x 110	16	05 09 141	D	7,7	9	270	02003	49,72
140 - 125 x 90	16	05 09 142	D	8,1	12	360	02004	49,72
140 - 125 x 75	16	05 09 143	D	7,8	12	360	02005	49,72
160 - 140 x 125	10	05 09 161	E	12,3	11	165	02006	67,68
160 - 140 x 110	10	05 09 162	E	14,8	14	210	02007	67,68
160 - 140 x 90	10	05 09 163	E	17,9	18	270	02008	67,68
200 - 180 x 140	10	05 09 202	E	9,9	6	90	02009	86,98
200 - 180 x 125	10	05 09 203	E	9,3	6	90	02010	86,98
200 - 180 x 110	10	05 09 204	E	8,9	6	90	02011	86,98
225 - 200 x 160	10	05 09 227	E	7,4	3	45	02012	130,46
225 - 200 x 140	10	05 09 228	E	7,2	3	45	02013	130,46
225 - 200 x 125	10	05 09 229	E	9,2	4	60	02014	130,46
250 - 225 x 200	10	05 09 251	E	7,5	2	30	02015	215,04
250 - 225 x 160	10	05 09 253	E	6,4	2	30	02016	215,04
250 - 225 x 140	10	05 09 254	E	8,9	3	45	02017	215,04
315 - 280 x 200	6	05 09 318 *	E	10,9	2	30	02018	666,12
315 - 280 x 160	6	05 09 320 *	E	10,5	2	30	02019	666,12

UP. 09. SF

C01 | ACP 010

RIDUZIONE CONICA ECCENTRICA

incollaggio

EXCENTRIC CONICAL REDUCER

solvent socket

SIZE	PN	REF.	PACK	kg	Q(B)	Q(P)	CODE	EUR
90 - 75 x 63	16	05 09 691	C	3,1	12	720	09030	13,04

Accessori PVC-U

Valvole PVC-U

Accessori PVC-C

Valvole PVC-C

Valvole Extreme

Evacuazione

Ricambi

PINZE FISSAGGIO TUBO - PIPE CLIPS

PP. 20. OP

C01 | OPP 041



PINZA APERTA

OPEN PIPE CLIP

SIZE	PN	REF.	PACK	kg	Q(B)	Q(P)	CODE	EUR
20		11 20 020	B	1,9	500	60.000	02132	1,11
25		11 20 025	B	1,8	350	42.000	02133	1,16
32		11 20 032	B	1,9	225	27.000	02134	1,46
40		11 20 040	B	1,8	150	18.000	02135	1,78
50		11 20 050	C	4,3	150	9.000	02136	2,17
63		11 20 063	C	3,2	100	6.000	02137	2,54
75		11 20 075	C	4,4	80	4.800	02138	3,39
90		11 20 090	C	4,9	50	3.000	02139	3,92
110		11 20 110	C	3,8	35	2.100	08908	7,60
125		11 20 125	C	4,1	30	1.800	08909	8,59
140		11 20 140	C	3,3	15	900	10955	9,34
160		11 20 160	C	3,7	15	900	08910	11,32
200		11 20 200	C	3,5	10	600	08911	13,84
225		11 20 225	C	2,5	4	240	10957	22,01

PP. 20. CL

C01 | OPP 041



PINZA CHIUSA

CLOSED PIPE CLIP

SIZE	PN	REF.	PACK	kg	Q(B)	Q(P)	CODE	EUR
50		11 20 450	C	2,5	100	6.000	02140	2,71
63		11 20 463	C	1,9	50	3.000	02141	3,05
75		11 20 475	C	2,6	40	2.400	02142	3,92
90		11 20 490	C	2,6	25	1.500	02143	4,63
110		11 20 510	C	3,8	30	1.800	08916	11,85
125		11 20 525	C	3,7	25	1.500	08917	13,34
140		11 20 540	C	3,8	15	900	10956	14,10
160		11 20 560	C	2,9	10	600	08918	16,41
200		11 20 599	C	3,3	8	480	08919	19,92
225		11 20 425	C	2,8	4	240	10958	28,68

PP. 20. CP

C01 | OPP 041



CLIP PINZA

BRIDLE CLAMP

SIZE	PN	REF.	PACK	kg	Q(B)	Q(P)	CODE	EUR
50		11 20 650	C	2,0	350	21.000	02144	0,63
63		11 20 663	C	2,1	250	15.000	02145	0,63
75		11 20 675	B	1,0	90	10.800	02146	0,73
90		11 20 690	C	2,5	144	8.640	02147	0,85
110		11 20 710	B	0,7	42	5.040	08912	5,01
125		11 20 725	D	4,6	180	5.400	08913	5,56
140		11 20 740	D	4,4	108	3.240	11300	5,85
160		11 20 760	C	1,3	32	1.920	08914	6,04
200		11 20 799	D	2,7	50	1.500	08915	7,10
225		11 20 625	D	2,5	20	600	11301	7,81

FLANGE E COLLARI - FLANGES AND BOLTS
UP. 10. SF

C01 | ACP 010*

COLLARE
incollaggio

FLANGE ADAPTOR (STUB FLANGE)
solvent socket

SIZE	PN	REF.	PACK	kg	Q(B)	Q(P)	CODE	EUR
20	16	05 10 020	B	2,0	200	24.000	07692	2,21
25	16	05 10 025	B	2,6	160	19.200	07693	2,59
32	16	05 10 032	B	1,9	80	9.600	07694	2,79
40	16	05 10 040	B	1,9	50	6.000	07695	3,46
50	16	05 10 050	B	2,4	40	4.800	02020	4,32
63	16	05 10 063	B	2,0	18	2.160	02021	6,91
75	16	05 10 075	C	4,8	29	1.740	02022	10,75
90	16	05 10 090	C	3,9	14	840	02023	12,86
110	16	05 10 110	D	9,3	20	600	02024	17,00
125	16	05 10 125	D	8,4	14	420	02025	36,48
140	16	05 10 140	D	8,2	10	300	02026	38,98
160	10	05 10 160	E	14,1	12	180	02027	43,59
200	10	05 10 200	E	11,1	7	105	02028	84,57
225	10	05 10 225	E	10,8	6	90	02029	90,91
250	10	05 10 250	F	17,2	5	50	02030	192,97
315	10	05 10 315	F	13,1	3	30	02031	299,10
400	6	05 10 400	F	8,1	1	10	05341-IT	590,43
500	4	05 10 402	G	14,7	2	20	05342-IT	628,44

UP. 11. FLG

C01 | ACP 010*

FLANGIA
FLANGE (BACKING RING)

SIZE	PN	REF.	PACK	kg	Q(B)	Q(P)	CODE	EUR
20	16	05 11 020	B	3,4	40	4.800	07696	5,67
25	16	05 11 025	B	3,3	30	3.600	07697	6,14
32	16	05 11 032	B	3,0	20	2.400	07698	6,82
40	16	05 11 040	B	5,0	22	2.640	07699	7,95
50	16	05 11 050	B	4,4	18	2.160	02032	9,22
63	16	05 11 063	C	5,8	20	1.200	02033	10,46
75	16	05 11 075	C	6,7	15	900	02034	13,88
90	16	05 11 090	D	16,1	34	1.020	02035	16,40
110	16	05 11 110	D	12,2	22	660	02036	19,98
125 *	16	05 11 125	D	10,8	18	540	02037	25,28
140	16	05 11 140	D	11,3	16	480	02038	29,01
125 (DN125) ¹	16	05 11 141	D	12,2	16	480	02039	42,64
160	10	05 11 160	D	12,6	12	360	02040	36,48
200 *	10	05 11 200	D	9,5	8	240	02041	71,52
225	10	05 11 225	D	6,7	5	150	02042	78,14
200 (DN200) ²	10	05 11 226	D	8,5	5	150	09039	74,99
250	10	05 11 250	E	12,8	6	90	02043	173,67
280	10	05 11 280	F	8,5	2	20	70959	357,76
315	10	05 11 315	F	14,7	6	60	02044	252,21
400	6	05 11 400	F	8,5	2	20	05343-IT	426,56
500	4	05 11 402	G	8,6	2	20	05344-IT	549,50

UP. 25. FLG

C01 | ACP 010*

FLANGIA
con collare

FLANGE ADAPTOR
stub and backing ring

SIZE	PN	REF.	PACK	kg	Q(B)	Q(P)	CODE	EUR
20	16	05 25 020 *	B	2,2	30	3.600	22575	9,19
25	16	05 25 025 *	B	2,1	20	2.400	22576	12,09
32	16	05 25 032 *	B	2,7	20	2.400	22577	14,47
40	16	05 25 040 *	C	4,5	20	1.200	22578	18,86
50	16	05 25 050 *	C	5,6	20	1.200	22579	22,16
63	16	05 25 063 *	C	4,5	12	720	22580	27,55
75	16	05 25 075	D	10,7	20	600	02226	29,18
90	16	05 25 090	D	10,2	15	450	02227	40,22
110	16	05 25 110	D	9,9	10	300	02228	50,40
125 *	16	05 25 125	E	17,4	16	240	02229	62,69
125 (DN125) ¹	16	05 25 126	E	20,5	15	225	02234	75,75
140	16	05 25 140	E	16,2	11	165	02230	75,75
160	10	05 25 160	E	15,9	8	120	02231	96,48
200*	10	05 25 200	E	11,9	5	75	02232	131,33
225	10	05 25 225	E	8,6	3	45	02233	149,57

1- Distanza tra i fori corrispondente a flangia DN125.
Hole distance corresponding to DN125 flange.
2- Distanza tra i fori corrispondente a flangia DN200.
Hole distance corresponding to DN200 flange.

* Misure speciali, accoppiabili con valvole Cepex (Consultare catalogo tecnico Cepex per le dimensioni complete)
Special sizes for Cepex valves (ask Cepex technical catalogue for complete sizes)

UP. 37. FLG

C01 | ACP 010*



FLANGIA CIECA

BLIND FLANGE

SIZE	PN	REF.	PACK	kg	Q(B)	Q(P)	CODE	EUR
20	16	05 37 020 *	B	3,0	40	4.800	22561	10,02
25	16	05 37 025 *	B	3,0	30	3.600	22562	11,48
32	16	05 37 032 *	B	2,8	20	2.400	22563	15,35
40	16	05 37 040 *	B	4,5	20	2.400	22564	20,02
50	16	05 37 050 *	B	3,9	16	1.920	22565	24,46
63	16	05 37 063 *	B	3,5	10	1.200	22566	30,07
75	16	05 37 075 *	B	3,4	7	840	22567	39,50
90	16	05 37 090 *	C	6,4	10	1.200	22568	45,51
110	16	05 37 110 *	C	5,0	6	360	22569	59,89
125 *	16	05 37 125 *	C	4,7	5	600	22570	67,86
140	16	05 37 140 *	C	5,7	5	300	22571	78,38
160	10	05 37 160 *	C	8,1	5	300	22572	88,31
200 (DN200) ²	10	05 37 200 *	D	11,2	5	150	22573	170,03
225	10	05 37 225 *	D	9,9	4	120	22574	179,46

* Misure speciali (Consultare catalogo tecnico Cepex per le dimensioni complete)
Special sizes (ask Cepex technical catalogue for complete sizes)

PP. 12. FLG

C01 | ACP 010*



FLANGIA PP

PP FLANGE (BACKING RING)

SIZE	PN	REF.	PACK	kg	Q(B)	Q(P)	CODE	EUR
50	16	05 12 050	B	3,5	18	2.160	02045	17,03
63	16	05 12 063	B	2,8	12	1.440	02046	21,14
75	16	05 12 075	C	5,1	16	960	02047	31,25
90	16	05 12 090	C	5,3	14	840	02048	37,67
110	16	05 12 110	C	3,4	7	420	02049	47,82
125 *	16	05 12 125	C	2,8	6	360	02050	61,09
140	16	05 12 140	C	3,4	6	360	02051	65,98
125 (DN125) ¹	16	05 12 141	C	4,0	6	360	02052	77,64
160	10	05 12 160	C	3,6	5	300	02053	82,05
200 *	10	05 12 200	D	7,9	9	270	02054	92,40
225	10	05 12 225	D	5,6	6	180	02055	101,79
200 (DN200) ²	10	05 12 226	D	6,6	6	180	02056	116,35

* Misure speciali, accoppiabili con valvole Cepex (Consultare catalogo tecnico Cepex per le dimensioni complete)
Special sizes for Cepex valves (ask Cepex technical catalogue for complete sizes)

EVA. 14

C01 | ACP 010*



GUARNIZIONE EVA

EVA FLAT GASKET

EVA: Ethilene Vinil Acetato

SIZE	PN	REF.	PACK	kg	Q(B)	Q(P)	CODE	EUR
20		05 14 020	B	1,4	80	9.600	07700	1,51
25		05 14 025	B	1,7	80	9.600	07701	1,54
32		05 14 032	B	2,1	80	9.600	07702	1,66
40		05 14 040	B	2,9	80	9.600	07703	2,21
50		05 14 050	B	2,8	60	7.200	02061	2,40
63		05 14 063	B	2,7	50	6.000	02062	2,79
75		05 14 075	B	2,5	40	4.800	02063	3,65
90		05 14 090	B	2,2	30	3.600	02064	4,13
110		05 14 110	B	2,1	30	3.600	02065	4,61
125		05 14 125	B	1,8	20	2.400	02066	5,28
140		05 14 140	B	2,1	20	2.400	02067	5,95
160		05 14 160	B	1,3	10	1.200	02068	6,82
200		05 14 200	B	1,7	10	1.200	02069	8,93
225		05 14 225	B	1,4	10	1.200	02070	11,43
250		05 14 250	B	1,8	10	1.200	02071	39,94
315		05 14 315	B	1,1	6	720	02072	51,76

EPDM. 14

C01 | ACP 010*



GUARNIZIONE EPDM

EPDM FLAT GASKET

SIZE	PN	REF.	PACK	kg	Q(B)	Q(P)	CODE	EUR
20	16	05 14 020 EPDM	B	1,4	80	9.600	66933	6,61
25	16	05 14 025 EPDM	B	1,7	80	9.600	66934	7,25
32	16	05 14 032 EPDM	B	2,1	80	9.600	66935	8,15
40	16	05 14 040 EPDM	B	2,9	80	9.600	66936	11,16
50	16	05 14 050 EPDM	B	2,8	60	7.200	66937	12,45
63	16	05 14 063 EPDM	B	2,7	50	6.000	66938	14,39
75	16	05 14 075 EPDM	B	2,5	40	4.800	66939	17,37
90	16	05 14 090 EPDM	B	2,2	30	3.600	66940	19,95
110	16	05 14 110 EPDM	B	2,1	30	3.600	66941	23,45
125	16	05 14 125 EPDM	B	1,8	20	2.400	66942	28,52
140	16	05 14 140 EPDM	B	2,1	20	2.400	66943	30,33
160	10	05 14 160 EPDM	B	1,3	10	1.200	66944	33,06
200	10	05 14 200 EPDM	B	1,7	10	1.200	66945	41,08
225	10	05 14 225 EPDM	B	1,4	10	1.200	66946	42,37
250	10	05 14 250 EPDM	B	1,8	10	1.200	66947	55,73
315	10	05 14 315 EPDM	B	1,1	6	720	66948	69,07
400	10	05 14 400 EPDM	B	1,0	6	720	05345-IT	121,13
500	10	05 14 500 EPDM	B	1,4	6	720	05346-IT	154,03

1- Distanza tra i fori corrispondente a flangia DN125.
Hole distance corresponding to DN125 flange.
2- Distanza tra i fori corrispondente a flangia DN200.
Hole distance corresponding to DN200 flange.

GIUNTI ANTIVIBRANTI PN10
FLANGED RUBBER FLEXIBLE JOINT

Assorbono vibrazioni, oscillazioni, contrazioni e dilatazioni.
Flange in acciaio cadmiato, corpo in EPDM.
Per il corretto accoppiamento a flange in PVC Consultare il diametro nominale corrispondente.

Per tubazioni D 125 accoppiare con flangia cod. 02039
Per tubazioni D 200 accoppiare con flangia cod. 09039

DN mm	DN "	Lungh.LIBERA	Lungh. MIN-MAX	CODE	EUR
50	2"	105	99 -110	71747	121,84
65	2 ½	115	103 -121	71748	155,59
80	3	130	118 -133	71749	179,05
100	4	135	117-145	71750	284,53
125	5	170	152-180	71751	290,71
150	6	180	162 -190	71752	394,74
200	8	205	180 -220	71753	528,13
250	10	240	215 -254	71754	823,94
300	12	260	235 -274	72485	1.135,03

VITE, DADO E RONDELLA
BOLTS, NUTS AND WASHERS

SIZE	PN	REF.	PACK	kg	Q(B)	Q(P)	CODE	EUR
M 12 x 60		05 91 060 *	B	4,3	48	2.880	16061	3,61
M 16 x 70		05 91 070 *	B	8,8	48	2.880	02437	4,13
M 16 x 80		05 91 080 *	B	9,4	48	2.880	02438	4,35
M 16 x 90		05 91 090 *	B	10,3	48	2.880	02439	4,83
M 16 x 100		05 91 100 *	B	11,0	48	2.880	66775	5,94
M 16 x 110		05 91 110 *	B	11,8	48	2.880	66776	6,33
M 16 x 120		05 91 120 *	B	8,3	32	1.920	02440	6,77
M 16 x 130		05 91 130 *	B	8,7	32	1.920	02441	7,43
M 16 x 140		05 91 140 *	B	9,3	32	1.920	02442	8,08
M 16 x 150		05 91 150 *	B	9,7	32	1.920	02443	8,59
M 16 x 160		05 91 160 *	B	7,7	24	1.440	02444	10,37
M 16 x 170		05 91 170 *	B	8,0	24	1.440	02445	11,03
M 16 x 200		05 91 200 *	B	6,1	16	960	07718	12,60
M 16 x 220		05 91 220 *	B	6,4	16	960	07719	13,83
M 16 x 240		05 91 240 *	B	6,7	16	960	07720	15,81
M 20 x 90		05 91 290 *	B	8,5	24	1.440	02446	9,06
M 20 x 110		05 91 310 *	B	9,5	24	1.440	02447	10,52
M 20 x 120		05 91 320 *	B	10,2	24	1.440	66777	11,41
M 20 x 130		05 91 330 *	B	9,5	24	1.440	66778	11,75
M 20 x 140		05 91 340 *	B	11,4	24	1.440	66779	12,34
M 20 x 150		05 91 350 *	B	9,5	24	1.440	66780	13,15
M 20 x 160		05 91 360 *	B	8,3	16	960	02448	16,68
M 20 x 180		05 91 380 *	B	9,0	16	960	02449	19,82
M 20 x 190		05 91 390 *	B	9,4	16	960	02450	19,82
M 20 x 200		05 91 400 *	B	9,8	16	960	20263	19,82
M 20 x 210		05 91 410 *	B	10,1	16	960	02451	22,03
M 20 x 230		05 91 430 *	B	11,0	16	960	02452	26,26
M 20 x 270		05 91 470 *	B	12,4	16	960	07721	33,27
M 20 x 310		05 91 510 *	C	13,8	16	480	07722	36,13
M 20 x 340		05 91 540 *	C	14,9	16	480	07723	41,91
M 24 x 140		05 91 640 *	C	14,9	16	480	66781	19,48
M 24 x 160		05 91 660 *	C	14,9	16	480	66782	21,21

CALOTTE - CAPS

UP. 07. SF

C01 | ACP 010*

CALOTTA

incollaggio

CAP

solvent socket

SIZE	PN	REF.	PACK	kg	Q(B)	Q(P)	CODE	EUR
16	16	05 07 016	B	0,6	200	24.000	01942	1,09
20	16	05 07 020	B	1,1	200	24.000	01943	1,17
25	16	05 07 025	B	2,4	200	24.000	01944	1,38
32	16	05 07 032	B	2,6	120	14.400	01945	1,66
40	16	05 07 040	B	2,6	70	8.400	01946	2,40
50	16	05 07 050	B	3,4	48	5.760	01947	3,46
63	16	05 07 063	B	2,5	24	2.880	01948	4,32
75	16	05 07 075	C	5,4	32	1.920	01949	10,75
90	16	05 07 090	C	5,8	16	960	01950	14,16
110	16	05 07 110	C	5,1	9	540	01951	20,85
125	16	05 07 125	D	10,3	15	450	01952	41,19
140	16	05 07 140	D	10,5	10	300	01953	42,81
160	10	05 07 160	D	8,0	6	180	01954	52,89
200	10	05 07 200	E	12,1	6	90	01955	97,05
225	10	05 07 225	E	9,8	4	60	01956	190,13
250	10	05 07 250	E	15,5	4	60	15776	350,15
315	10	05 07 315	F	16,3	2	20	15777	536,93

UP. 07. FT

C01 | ACP 040

CALOTTA

filetto femmina

CAP

BSP female thread

SIZE	PN	REF.	PACK	kg	Q(B)	Q(P)	CODE	EUR
3/8"	10	05 07 616	B	1,7	200	24.000	01957	2,32
1/2"	10	05 07 620	B	2,4	200	24.000	01958	2,40
3/4"	10	05 07 625	B	3,4	160	19.200	01959	2,55
1"	10	05 07 632	B	2,9	80	9.600	01960	2,79
1 1/4"	10	05 07 640	B	3,3	50	6.000	01961	4,05
1 1/2"	10	05 07 650	B	4,1	40	4.800	01962	4,58
2"	10	05 07 663	B	4,1	22	2.640	01963	6,43
2 1/2"	10	05 07 675	B	2,9	12	1.440	01964	21,12
3"	10	05 07 690	C	6,7	16	960	01965	27,75
4"	10	05 07 710	C	5,2	8	480	01966	35,90

UP. 19. MT

C01 | ACP 040

TAPPO

filetto maschio

PLUG

BSP male thread

SIZE	PN	REF.	PACK	kg	Q(B)	Q(P)	CODE	EUR
1/4"	10	05 19 612	B	0,3	200	24.000	02121	1,38
3/8"	10	05 19 616	B	1,1	200	24.000	02122	1,38
1/2"	10	05 19 620	B	2,5	200	24.000	02123	1,54
3/4"	10	05 19 625	B	3,5	200	24.000	02124	1,90
1"	10	05 19 632	B	3,1	120	14.400	02125	2,40
1 1/4"	10	05 19 640	B	3,4	80	9.600	02126	3,37
1 1/2"	10	05 19 650	B	4,0	60	7.200	02127	3,93
2"	10	05 19 663	C	7,0	70	4.200	02128	5,10
2 1/2"	10	05 19 675	C	6,8	45	2.700	02129	17,38
3"	10	05 19 690	C	7,3	33	1.980	02130	20,93
4"	10	05 19 710	C	6,0	12	720	02131	34,95

Accessori PVC-U

Valvole PVC-U

Accessori PVC-C

Valvole PVC-C

Valvole Extreme

Evacuazione

Ricambi

ADATTATORI E MANICOTTI NIPPLO - NIPPLES

UP. 15. SFMT

C01 | ACP 030



MANICOTTO NIPPLO
incollaggio e filetto maschio

ADAPTOR NIPPLE
solvent socket x BSP male thread

SIZE	PN	REF.	PACK	kg	Q(B)	Q(P)	CODE	EUR
16 - 12 x 3/8"	10	05 15 416	B	1,3	200	24.000	02073	1,52
20 - 16 x 1/2"	10	05 15 420	B	2,5	200	24.000	02074	1,59
20 - 16 x 3/8"	10	05 15 421	B	2,4	200	24.000	02075	1,59
25 - 20 x 3/4"	10	05 15 425	B	2,2	120	14.400	02076	2,30
25 - 20 x 1/2"	10	05 15 426	B	2,5	140	16.800	02077	2,30
25 - 20 x 3/8"	10	05 15 427	B	2,3	140	16.800	02078	2,30
32 - 25 x 1"	10	05 15 432	B	2,6	80	9.600	02079	2,50
32 - 25 x 3/4"	10	05 15 433	B	2,2	80	9.600	02080	2,50
32 - 25 x 1/2"	10	05 15 434	B	2,1	80	9.600	02081	2,50
40 - 32 x 1 1/4"	10	05 15 440	B	2,6	50	6.000	02082	3,46
40 - 32 x 1"	10	05 15 441	B	2,4	50	6.000	02083	3,46
40 - 32 x 3/4"	10	05 15 442	B	2,1	50	6.000	02084	3,46
50 - 40 x 1 1/2"	10	05 15 450	C	5,6	68	4.080	02085	3,67
50 - 40 x 1 1/4"	10	05 15 451	C	5,2	68	4.080	02086	3,83
50 - 40 x 1"	10	05 15 452	C	5,0	70	4.200	02087	3,83
63 - 50 x 2"	10	05 15 463	C	5,9	46	2.760	02088	5,80
63 - 50 x 1 1/2"	10	05 15 464	C	7,2	60	3.600	02089	5,80
63 - 50 x 1 1/4"	10	05 15 465	C	6,9	60	3.600	02090	6,27
75 - 63 x 2 1/2"	10	05 15 475	C	4,7	24	1.440	02091	9,60
75 - 63 x 2"	10	05 15 476	C	5,5	30	1.800	02092	9,60
75 - 63 x 1 1/2"	10	05 15 477	C	5,1	30	1.800	02093	9,60
90 - 75 x 3"	10	05 15 490	C	3,6	12	720	02094	14,49
90 - 75 x 2 1/2"	10	05 15 491	C	4,3	15	900	02095	14,49
90 - 75 x 2"	10	05 15 492	C	6,3	24	1.440	02096	14,49
110 - 90 x 4"	10	05 15 510	C	3,8	6	360	02097	28,32
110 - 90 x 3"	10	05 15 511	C	5,1	9	540	02098	28,32
110 - 90 x 2 1/2"	10	05 15 512	C	5,0	9	540	02099	28,32

UP. 17. SFMT

C01 | ACP 030



MANICOTTO FM
incollaggio e filetto maschio

ADAPTOR BUSH
solvent socket x BSP male thread

SIZE	PN	REF.	PACK	kg	Q(B)	Q(P)	CODE	EUR
20 x 1/2"	10	05 17 420	B	2,7	200	24.000	02102	2,11
25 x 3/4"	10	05 17 425	B	2,5	120	14.400	02103	2,40
32 x 1"	10	05 17 432	B	2,4	60	7.200	02104	2,79
40 x 1 1/4"	10	05 17 440	C	4,6	80	4.800	02105	3,93
50 x 1 1/2"	10	05 17 450	C	6,2	72	4.320	02106	4,52
63 x 2"	10	05 17 463	C	6,9	50	3.000	02107	6,91
75 x 2 1/2"	10	05 17 475	C	6,1	24	1.440	02108	12,48
90 x 3"	10	05 17 490	D	11,7	28	840	02109	24,18
110 x 4"	10	05 17 510	D	6,3	10	300	02110	40,22

C01 | ACP 030



MANICOTTO FM (filetto lungo cil.)
incollaggio e filetto maschio

ADAPTOR BUSH (cyl. Long thread)
solvent socket x male thread

SIZE	PN	REF.	PACK	kg	Q(B)	Q(P)	CODE	EUR
50x1"1/2-40			D	16,3	150	4.500	0599001	4,42
63x2"-44			D	14,3	85	2.550	0599002	6,80
75x2"1/2-44			C	7,3	24	1.440	0599003	10,80
90x3"-45			D	13,1	28	840	0599004	21,54

UP. 18. MT

C01 | ACP 040



NIPPLO
filetto maschio

HEXAGON NIPPLE
BSP male thread

SIZE	PN	REF.	PACK	kg	Q(B)	Q(P)	CODE	EUR
3/8"	10	05 18 616	B	1,2	200	24.000	02111	1,98
1/2"	10	05 18 620	B	2,5	200	24.000	02112	1,74
3/4"	10	05 18 625	B	2,2	120	14.400	02113	2,30
1"	10	05 18 632	B	2,4	80	9.600	02114	2,69
1 1/4"	10	05 18 640	B	2,4	50	6.000	02115	3,54
1 1/2"	10	05 18 650	B	2,4	36	4.320	02116	3,93
2"	10	05 18 663	C	4,7	46	2.760	02117	5,48
2 1/2"	10	05 18 675	C	5,2	30	1.800	02118	14,41
3"	10	05 18 690	C	2,9	12	720	02119	19,48
4"	10	05 18 710	C	3,2	6	360	02120	31,00

UP. 31. SFT

C01 | ACP 030

ADATTATORE MISTO
 incollaggio e filetto femmina

ADAPTOR NIPPLE
 solvent socket x BSP female thread

SIZE	PN	REF.	PACK	kg	Q(B)	Q(P)	CODE	EUR
20 - 16 x 3/4"	10	05 31 420	B	2,9	120	14.400	02243	3,65
20 - 16 x 1/2"	10	05 31 421	B	2,8	140	16.800	02244	3,46
20 - 16 x 3/8"	10	05 31 422	B	2,7	160	19.200	02245	3,37
20 - 16 x 1/4"	10	05 31 423	B	3,4	200	24.000	02246	3,37
25 - 20 x 1"	10	05 31 425	B	2,3	60	7.200	02247	3,93
25 - 20 x 3/4"	10	05 31 426	B	2,6	100	12.000	02248	3,93
25 - 20 x 1/2"	10	05 31 427	B	2,5	120	14.400	02249	3,42
32 - 25 x 1 1/4"	10	05 31 432	B	1,9	30	3.600	02250	5,00
32 - 25 x 1"	10	05 31 433	B	2,6	60	7.200	02251	4,70
32 - 25 x 3/4"	10	05 31 434	B	2,8	80	9.600	02252	4,22
32 - 25 x 1/2"	10	05 31 435	B	2,6	80	9.600	24822	4,35
40 - 32 x 1 1/2"	10	05 31 440	B	2,7	30	3.600	02253	6,43
40 - 32 x 1 1/4"	10	05 31 441	C	4,2	50	3.000	02254	5,42
40 - 32 x 1"	10	05 31 442	C	4,9	80	4.800	02255	5,42
40 - 32 x 3/4"	10	05 31 443	C	4,9	80	4.800	71572	6,53
50 - 40 x 2"	10	05 31 450	C	7,5	45	2.700	02256	8,54
50 - 40 x 1 1/2"	10	05 31 451	C	4,1	40	2.400	02257	6,91
50 - 40 x 1 1/4"	10	05 31 452	C	3,9	40	2.400	02258	6,91
63 - 50 x 2 1/2"	10	05 31 463	C	5,6	24	1.440	02259	17,92
63 - 50 x 2"	10	05 31 464	C	6,9	36	2.160	02260	12,42
63 - 50 x 1 1/2"	10	05 31 465	C	5,4	36	2.160	02261	12,42
75 - 63 x 3"	10	05 31 475	C	5,4	16	960	02262	21,12
75 - 63 x 2 1/2"	10	05 31 476	C	2,9	12	720	02263	19,30
75 - 63 x 2"	10	05 31 477	C	5,4	24	1.440	02264	16,40
90 - 75 x 4"	10	05 31 490	C	5,8	10	600	02265	29,27
90 - 75 x 3"	10	05 31 491	C	3,5	9	540	02266	24,09
90 - 75 x 2 1/2"	10	05 31 492	C	3,1	9	540	02267	23,19
110 - 90 x 4"	10	05 31 511	C	4,1	6	360	02268	30,32
110 - 90 x 3"	10	05 31 512	C	3,6	6	360	02269	33,03

UP. 32. MFT

C01 | ACP 040

RIDUZIONE FILETTATA
 filetto maschio e femmina

REDUCER
 BSP male x female thread

SIZE	PN	REF.	PACK	kg	Q(B)	Q(P)	CODE	EUR
3/8" x 1/2"	10	05 32 616	B	3,7	200	24.000	02270	3,84
1/2" x 3/4"	10	05 32 620	B	3,0	120	14.400	02271	3,93
1/2" x 3/8"	10	05 32 621	B	1,9	200	24.000	02272	2,21
3/4" x 1"	10	05 32 625	B	2,7	70	8.400	02273	4,13
3/4" x 1 1/2"	10	05 32 626	B	2,3	120	14.400	02274	2,21
3/4" x 3/8"	10	05 32 627	B	2,4	140	16.800	02275	2,21
1" x 1 1/4"	10	05 32 632	B	2,6	40	4.800	02276	4,52
1" x 3/4"	10	05 32 633	B	2,7	80	9.600	02277	3,98
1" x 1/2"	10	05 32 634	B	2,4	80	9.600	02278	3,98
1" x 3/8"	10	05 32 635	B	2,8	100	12.000	02279	3,98
1 1/4" x 1 1/2"	10	05 32 640	B	3,4	40	4.800	02280	5,76
1 1/4" x 1"	10	05 32 641	B	2,6	50	6.000	02281	4,42
1 1/4" x 3/4"	10	05 32 642	B	2,4	50	6.000	02282	4,42
1 1/4" x 1/2"	10	05 32 643	B	2,3	50	6.000	02283	4,42
1 1/2" x 2"	10	05 32 650	B	2,8	18	2.160	02284	6,91
1 1/2" x 1 1/4"	10	05 32 651	C	4,7	70	4.200	02285	5,99
1 1/2" x 1"	10	05 32 652	C	4,5	70	4.200	02286	5,99
1 1/2" x 3/4"	10	05 32 653	C	5,3	90	5.400	02287	5,99
2" x 2 1/2"	10	05 32 663	C	7,4	36	2.160	02288	14,50
2" x 1 1/2"	10	05 32 664	C	4,9	48	2.880	02289	8,66
2" x 1 1/4"	10	05 32 665	C	4,6	48	2.880	02290	8,66
2" x 1"	10	05 32 666	C	4,5	50	3.000	02291	8,66
2 1/2" x 3"	10	05 32 675	C	5,2	16	960	02292	18,43
2 1/2" x 2"	10	05 32 676	C	5,7	32	1.920	02293	14,77
2 1/2" x 1 1/2"	10	05 32 677	C	5,5	32	1.920	02294	14,77
2 1/2" x 1 1/4"	10	05 32 678	C	6,0	40	2.400	02295	14,77
3" x 4"	10	05 32 690	C	6,8	12	720	02296	31,58
3" x 2 1/2"	10	05 32 691	C	5,7	24	1.440	02297	19,58
3" x 2"	10	05 32 692	C	5,4	24	1.440	02298	19,58
3" x 1 1/2"	10	05 32 693	C	4,9	24	1.440	02299	19,58
4" x 3"	10	05 32 711	C	4,4	9	540	02300	32,07
4" x 2 1/2"	10	05 32 712	C	5,6	12	720	02301	32,07
4" x 2"	10	05 32 713	C	5,7	12	720	02302	32,07

Accessori PVC-U

Valvole PVC-U

Accessori PVC-C

Valvole PVC-C

Valvole Extreme

Evacuazione

Ricambi

UP. 33. MT

C01 | ACP 040

**NIPPOLO RIDOTTO**

filetto maschio

REDUCING NIPPLE

BSP male thread

SIZE	PN	REF.	PACK	kg	Q(B)	Q(P)	CODE	EUR
1/2" x 3/4"	10	05 33 620	B	1,7	200	24.000	02303	2,79
3/4" x 1/2"	10	05 33 625	B	2,8	160	19.200	02304	3,37
3/4" x 3/8"	10	05 33 626	B	2,6	160	19.200	02305	3,37
1" x 3/4"	10	05 33 632	B	2,6	80	9.600	02306	3,84
1" x 1/2"	10	05 33 633	B	2,3	90	10.800	02307	3,84
1" x 3/8"	10	05 33 634	B	2,5	90	10.800	02308	3,84
1 1/4" x 1"	10	05 33 640	B	2,4	50	6.000	02309	4,61
1 1/4" x 3/4"	10	05 33 641	B	2,7	60	7.200	02310	4,61
1 1/4" x 1/2"	10	05 33 642	B	2,6	60	7.200	02311	4,61
1 1/2" x 1 1/4"	10	05 33 650	B	2,4	38	4.560	02312	5,95
1 1/2" x 1"	10	05 33 651	B	2,7	60	7.200	02313	5,95
1 1/2" x 3/4"	10	05 33 652	B	3,4	60	7.200	02314	5,95
2" x 1 1/2"	10	05 33 663	B	2,2	24	2.880	02315	8,15
2" x 1 1/4"	10	05 33 664	B	2,9	33	3.960	02316	8,15
2" x 1"	10	05 33 665	B	2,9	33	3.960	02317	8,15
2 1/2" x 2"	10	05 33 675	C	4,9	30	1.800	02318	16,61
2 1/2" x 1 1/2"	10	05 33 676	C	6,7	45	2.700	02319	16,61
2 1/2" x 1 1/4"	10	05 33 677	C	6,6	45	2.700	02320	16,61
3" x 2 1/2"	10	05 33 690	C	5,4	24	1.440	02321	20,25
3" x 2"	10	05 33 691	C	5,0	24	1.440	02322	20,25
3" x 1 1/2"	10	05 33 692	C	7,3	36	2.160	02323	20,25
4" x 3"	10	05 33 710	C	5,7	12	720	02324	30,43
4" x 2 1/2"	10	05 33 711	C	5,6	12	720	02325	30,43
4" x 2"	10	05 33 712	C	5,4	12	720	02326	30,43

UP. 34. MFT

C01 | ACP 040

**RIDUZIONE FILETTATA CORTA**

filetto maschio e femmina

SHORT REDUCING NIPPLE

BSP male x female thread

SIZE	PN	REF.	PACK	kg	Q(B)	Q(P)	CODE	EUR
1/2" x 1/4"	10	05 34 621	B	2,3	200	24.000	23087	2,26
3/4" x 1/2"	10	05 34 625	B	2,6	200	24.000	20147	2,66
3/4" x 1/4"	10	05 34 627	B	3,7	200	24.000	23088	2,68
3/4" x 1/8"	10	05 34 628	B	3,8	200	24.000	28081	2,68
1" x 3/4"	10	05 34 632	B	2,2	120	14.400	20148	3,26
1" x 1/4"	10	05 34 635	B	3,2	120	14.400	23089	3,30
1 1/4" x 1"	10	05 34 640	B	2,5	80	9.600	20149	3,98
1 1/2" x 1 1/4"	10	05 34 650	B	1,8	50	6.000	20150	4,59
2" x 1 1/2"	10	05 34 663	B	2,4	36	4.320	20151	6,98
2 1/2" x 2"	10	05 34 675	B	2,6	22	2.640	20152	10,24
3" x 2 1/2"	10	05 34 690	B	2,4	18	2.160	20153	16,80
4" x 3"	10	05 34 710	B	2,5	6	720	20154	38,12

BOCCHETTONI - UNIONS
UP. 50. SF

C01 | ACP 050

BOCCHETTONE

incollaggio

UNION

solvent socket

SIZE	PN	REF.	PACK	kg	Q(B)	Q(P)	CODE	EUR
16	16	05 50 016	B	2,3	100	12.000	20157	5,00
20	16	05 50 020	B	3,1	80	9.600	02327	4,45
25	16	05 50 025	B	2,6	40	4.800	02328	5,76
32	16	05 50 032	B	2,8	30	3.600	02329	7,78
40	16	05 50 040	C	6,4	40	2.400	02330	10,08
50	16	05 50 050	C	5,5	30	1.800	02331	11,18
63	16	05 50 063	C	4,1	12	720	02332	15,70
75	10	05 50 075	D	8,7	16	480	02333	54,72
90	10	05 50 090	D	9,5	12	360	02334	63,84
110	10	05 50 110	D	7,6	5	150	02335	74,29

UP. 50. SFT

C01 | ACP 050

BOCCHETTONE MISTO

incollaggio e filetto femmina

UNION

solvent socket x BSP female thread

SIZE	PN	REF.	PACK	kg	Q(B)	Q(P)	CODE	EUR
16 x 3/8"	10	05 50 416	B	2,4	100	12.000	20158	7,49
20 x 1/2"	10	05 50 420	B	3,0	80	9.600	02336	7,39
25 x 3/4"	10	05 50 425	B	2,6	40	4.800	02337	9,02
32 x 1"	10	05 50 432	B	3,2	30	3.600	02338	12,00
40 x 1 1/4"	10	05 50 440	C	6,6	40	2.400	02339	14,41
50 x 1 1/2"	10	05 50 450	C	5,9	30	1.800	02340	20,06
63 x 2"	10	05 50 463	C	4,4	12	720	02341	25,44
75 x 2 1/2"	10	05 50 475	D	8,8	16	480	02342	69,32
90 x 3"	10	05 50 490	D	9,7	12	360	02343	79,68
110 x 4"	10	05 50 510	D	8,0	5	150	02344	92,92

UP. 50. FT

C01 | ACP 050

BOCCHETTONE

filetto femmina

UNION

BSP female thread

SIZE	PN	REF.	PACK	kg	Q(B)	Q(P)	CODE	EUR
3/8"	10	05 50 616	B	2,3	100	12.000	20159	7,20
1/2"	10	05 50 620	B	3,0	80	9.600	02345	7,20
3/4"	10	05 50 625	B	2,6	40	4.800	02346	8,15
1"	10	05 50 632	B	2,9	30	3.600	02347	11,13
1 1/4"	10	05 50 640	C	6,4	40	2.400	02348	13,25
1 1/2"	10	05 50 650	C	6,3	30	1.800	02349	18,82
2"	10	05 50 663	C	4,7	12	720	02350	25,34
2 1/2"	10	05 50 675	C	4,5	8	480	07713	57,86
3"	10	05 50 690	C	4,4	5	300	07714	78,43
4"	10	05 50 710	C	3,2	2	120	07715	120,43

UP. 51. SMF

C01 | ACP 050

BOCCHETTONE

incollaggio femmina e maschio

UNION

solvent socket

SIZE	PN	REF.	PACK	kg	Q(B)	Q(P)	CODE	EUR
50	16	05 51 050	C	4,7	20	1.200	02351	12,42
63	16	05 51 063	C	5,2	12	720	02352	19,83

UP. 51. SMT

C01 | ACP 050

BOCCHETTONE MISTO

incollaggio femmina e filetto maschio

UNION

solvent socket x BSP male thread

SIZE	PN	REF.	PACK	kg	Q(B)	Q(P)	CODE	EUR
16 x 3/8"	10	05 51 416	B	2,7	100	12.000	20160	6,91
20 x 1/2"	10	05 51 420	B	3,4	80	9.600	02353	6,72
25 x 3/4"	10	05 51 425	B	2,8	40	4.800	02354	7,11
32 x 1"	10	05 51 432	B	3,3	30	3.600	02355	9,22
40 x 1 1/4"	10	05 51 440	C	6,4	36	2.160	02356	10,84
50 x 1 1/2"	10	05 51 450	C	6,4	30	1.800	02357	12,77
63 x 2"	10	05 51 463	C	4,9	12	720	02358	20,73
75 x 2 1/2"	10	05 51 475	D	7,6	16	480	02359	59,43
90 x 3"	10	05 51 490	D	9,4	10	300	02360	79,68
110 x 4"	10	05 51 510	D	6,2	4	120	02361	102,91

UP. 51. MFT

C01 | ACP 050

**BOCCHETTONE**

filetto femmina e maschio

UNION

BSP female x male thread

SIZE	PN	REF.	PACK	kg	Q(B)	Q(P)	CODE	EUR
3/8" x 3/8"	10	05 51 616	B	2,7	100	12.000	20161	7,68
1/2" x 1/2"	10	05 51 620	B	3,4	80	9.600	02362	7,68
3/4" x 3/4"	10	05 51 625	B	2,7	40	4.800	02363	7,97
1" x 1"	10	05 51 632	B	3,3	30	3.600	02364	10,56
1 1/4" x 1 1/4"	10	05 51 640	C	6,4	36	2.160	02365	12,19
1 1/2" x 1 1/2"	10	05 51 650	C	4,5	20	1.200	02366	15,45
2" x 2"	10	05 51 663	C	5,1	12	720	02367	24,86
2 1/2" x 2 1/2"	10	05 51 675	C	3,8	6	360	02368	68,54
3" x 3"	10	05 51 690	C	4,6	5	300	02369	91,20
4" x 4"	10	05 51 710	D	7,2	4	120	02370	119,91

UP. 51. SMT2

C01 | ACP 050

**BOCCHETTONE MISTO**

incollaggio femmina e filetto maschio

UNION

solvent socket x BSP male thread

SIZE	PN	REF.	PACK	kg	Q(B)	Q(P)	CODE	EUR
50 x 1 1/2"	10	05 51 250	C	6,9	30	1.800	07716	14,68
50 x 2"	10	05 51 251	C	4,8	12	720	26638	20,64
63 x 2"	10	05 51 263	C	4,9	12	720	07717	22,69

UP. 51. SFMT

C01 | ACP 050

**BOCCHETTONE MISTO**

incollaggio femmina e filetto maschio

UNION

solvent socket x BSP male thread

SIZE	PN	REF.	PACK	kg	Q(B)	Q(P)	CODE	EUR
50 x 2"	10	05 51 451	C	4,8	20	1.200	09033	22,91

UP. 57. SFMT

C01 | ACP 050

**MANICOTTO ORIENTABILE**

incollaggio femmina e filetto maschio

SELF-ALIGN UNION

solvent socket x BSP male thread

SIZE	PN	REF.	PACK	kg	Q(B)	Q(P)	CODE	EUR
50 x 1 1/2"	10	05 57 550	B	2,9	6	720	18874	28,35

UP. 21. SFMT

C01 | ACP 030

**PEZZO FOLLE MISTO**

incollaggio femmina e filetto maschio

UNION BUSH

solvent socket x BSP male thread

SIZE	PN	REF.	PACK	kg	Q(B)	Q(P)	CODE	EUR
16 x 3/4"	10	05 21 416	B	1,0	100	12.000	41526	1,85
20 x 1"	10	05 21 420	B	3,0	200	24.000	02148	1,96
25 x 1 1/4"	10	05 21 425	B	3,5	150	18.000	02150	2,38
32 x 1 1/2"	10	05 21 432	C	6,8	200	12.000	02151	3,39
40 x 2"	10	05 21 440	B	3,6	60	7.200	02153	4,09
50 x 2 1/4"	10	05 21 450	C	5,8	80	4.800	02154	5,46
63 x 2 3/4"	10	05 21 463	C	6,2	46	2.760	02156	8,32
75 x 3 1/2"	10	05 21 475	C	5,8	28	1.680	02157	23,05
90 x 4"	10	05 21 490	C	4,7	16	960	02158	30,09
110 x 5 1/2"	10	05 21 510	D	10,9	20	600	02159	43,72

UP. 21. MFT

C01 | ACP 040

**PEZZO FOLLE**

filetto maschio e femmina

UNION BUSH

BSP male x female thread

SIZE	PN	REF.	PACK	kg	Q(B)	Q(P)	CODE	EUR
3/8" x 3/4"	10	05 21 616	C	6,2	400	24.000	41527	2,38
1" x 1/2"	10	05 21 620	B	3,0	200	24.000	02160	2,44
1 1/4" x 3/4"	10	05 21 625	B	3,6	150	18.000	02162	3,04
1 1/2" x 1"	10	05 21 632	B	3,5	100	12.000	02163	4,34
2" x 1 1/4"	10	05 21 640	B	3,6	60	7.200	02165	5,32
2 1/4" x 1 1/2"	10	05 21 650	C	6,8	80	4.800	02166	7,11
2 3/4" x 2"	10	05 21 663	C	7,6	46	2.760	02168	10,41
3 1/2" x 2 1/2"	10	05 21 675	C	7,1	30	1.800	02169	29,37
4" x 3"	10	05 21 690	C	5,3	16	960	02170	37,69
5 1/2" x 4"	10	05 21 710	C	4,8	8	480	02171	52,25

UP. 22. SF

C01 | ACP 010

PEZZO FOLLE

incollaggio

UNION END

solvent socket

SIZE	PN	REF.	PACK	kg	Q(B)	Q(P)	CODE	EUR
16	16	05 22 016	B	3,1	600	72.000	20229	1,15
20	16	05 22 020	B	2,9	300	36.000	02172	1,15
25	16	05 22 025	B	3,1	150	18.000	02173	1,38
32	16	05 22 032	B	2,7	125	15.000	02174	2,21
40	16	05 22 040	B	2,6	60	7.200	02175	2,40
50	16	05 22 050	B	2,1	50	6.000	02176	3,84
63	16	05 22 063	C	4,5	60	3.600	02177	4,52
75	16	05 22 075	C	5,4	35	2.100	02178	11,81
90	16	05 22 090	C	3,5	18	1.080	02179	14,89
110	16	05 22 110	C	4,3	10	600	02180	22,36

UP. 22. FT

C01 | ACP 040

PEZZO FOLLE

filetto femmina

UNION END

BSP female thread

SIZE	PN	REF.	PACK	kg	Q(B)	Q(P)	CODE	EUR
3/8"	10	05 22 616	B	3,1	600	72.000	20230	1,80
1/2"	10	05 22 620	B	2,8	300	36.000	16310	1,98
3/4"	10	05 22 625	B	3,5	200	24.000	16311	2,45
1"	10	05 22 632	B	2,8	125	15.000	16312	3,09
1 1/4"	10	05 22 640	B	2,8	60	7.200	16313	3,55
1 1/2"	10	05 22 650	B	2,9	50	6.000	16314	5,42
2"	10	05 22 663	C	6,6	60	3.600	16315	6,63
2 1/2"	10	05 22 675	C	6,1	36	2.160	16316	16,84
3"	10	05 22 690	C	4,6	20	1.200	16317	20,27
4"	10	05 22 710	C	4,6	10	600	16318	57,06

UP. 22. MT

C01 | ACP 040

PEZZO FOLLE

filetto maschio

UNION END

BSP male thread

SIZE	PN	REF.	PACK	kg	Q(B)	Q(P)	CODE	EUR
3/8"	10	05 22 416	B	1,0	100	12.000	25959	2,94
1/2"	10	05 22 420	B	3,3	250	30.000	25960	3,19
3/4"	10	05 22 425	B	2,6	125	15.000	25961	3,59
1"	10	05 22 432	B	2,9	80	9.600	25962	4,24
1 1/4"	10	05 22 440	B	2,9	50	6.000	25963	5,18
1 1/2"	10	05 22 450	C	4,5	60	3.600	25964	5,98
2"	10	05 22 463	C	5,8	40	2.400	25965	10,03
2 1/2"	10	05 22 475	C	7,9	30	1.800	25966	17,37
3"	10	05 22 490	C	6,1	18	1.080	25967	23,67
4"	10	05 22 510	C	9,8	15	900	25968	31,13

UP. 22. SM

C01 | ACP 010

PEZZO FOLLE

incollaggio maschio

UNION END

male solvent socket

SIZE	PN	REF.	PACK	kg	Q(B)	Q(P)	CODE	EUR
50	16	05 22 250	C	5,4	60	3.600	25957	4,12
63	16	05 22 263	C	5,4	30	1.800	25958	7,65

UP. 23. FT

C01 | ACP 040

GHIERA

filetto femmina

UNION NUT

BSP female thread

SIZE	PN	REF.	PACK	kg	Q(B)	Q(P)	CODE	EUR
3/4" (3/8")	10	05 23 625	B	3,3	300	36.000	02187	1,90
1" (1/2")	10	05 23 632	B	2,8	200	24.000	02188	1,90
1 1/4" (3/4")	10	05 23 640	B	2,4	100	12.000	02189	2,27
41,5	10	05 23 641	C	4,6	200	12.000	02190	2,27
1 1/2" (1")	10	05 23 650	B	2,7	70	8.400	02191	3,51
2" (1 1/4")	10	05 23 663	B	2,7	45	5.400	02192	3,87
2 1/4" (1 1/2")	10	05 23 664	B	2,4	30	3.600	02193	4,74
2"	10	05 23 665	C	5,0	90	5.400	02194	4,14
2 1/2"	10	05 23 675	B	2,7	36	4.320	02195	5,46
2 3/4" (2")	10	05 23 676	C	5,2	40	2.400	02196	8,46
3 1/2" (2 1/2")	10	05 23 692	C	5,4	30	1.800	02197	24,69
4" (3")	10	05 23 710	C	4,9	16	960	02198	37,63
5 1/2" (4")	10	05 23 741	C	3,3	6	360	02199	47,74

Tra parentesi si riporta la dimensione dell'unione bocchettonata corrispondente.
The size of the corresponding union is indicated in brackets.

PORTAGOMMA - SPIGOTS**UP. 24. SF**

C01 | ACP 010

**PORTAGOMMA**

incollaggio maschio

SPIGOT CONNECTION

solvent socket

SIZE	PN	REF.	PACK	kg	Q(B)	Q(P)	CODE	EUR
16 x 16	10	05 24 016	B	1,3	200	24.000	02200	1,53
20 x 18	10	05 24 018	B	2,3	200	24.000	02201	1,76
20 x 20	10	05 24 020	B	2,3	200	24.000	02202	1,81
25 x 25	10	05 24 025	B	2,0	120	14.400	02203	2,11
32 x 30	10	05 24 032	B	2,2	80	9.600	02204	2,42
40 x 40	10	05 24 040	B	1,8	40	4.800	02205	2,96
50 x 50	10	05 24 050	B	2,5	30	3.600	02206	4,32
50 x 38	10	05 24 051	B	3,0	40	4.800	02207	4,32
63 x 60	10	05 24 063	B	2,4	18	2.160	02208	7,00

UP. 24. MT

C01 | ACP 040

**PORTAGOMMA**

filetto maschio

SPIGOT CONNECTION

BSP male thread

SIZE	PN	REF.	PACK	kg	Q(B)	Q(P)	CODE	EUR
¾" x 16	10	05 24 616	B	1,7	200	24.000	02217	1,54
½" x 18	10	05 24 618	B	2,7	200	24.000	02218	1,76
½" x 20	10	05 24 620	B	2,4	180	21.600	02219	2,30
¾" x 25	10	05 24 625	B	2,5	120	14.400	02220	2,40
¾" x 20	10	05 24 626	B	2,5	140	16.800	15763	2,50
1" x 30	10	05 24 632	B	2,1	60	7.200	02221	3,37
1" x 25	10	05 24 633	B	2,5	80	9.600	09031	3,37
1¼" x 40	10	05 24 640	B	1,8	30	3.600	02222	3,93
1½" x 50	10	05 24 650	B	2,7	30	3.600	02223	4,70
1½" x 38	10	05 24 651	B	2,8	36	4.320	02224	4,70
1½" x 40	10	05 24 652	B	3,0	36	4.320	09032	4,80
2" x 60	10	05 24 663	B	2,0	15	1.800	02225	7,59

UP. 55. SPI

C01 | ACP 050

**PORTAGOMMA CON GHIERA****SPIGOT AND NUT UNION**

SIZE	PN	REF.	PACK	kg	Q(B)	Q(P)	CODE	EUR
16 x ¾"		05 55 016	B	2,1	100	12.000	02399	5,11
18 x ¾"		05 55 018	B	2,3	100	12.000	02400	5,37
20 x ¾"		05 55 020	B	1,9	80	9.600	02401	5,53
25 x 1"		05 55 025	B	1,9	60	7.200	02402	5,74
20 x 1"		05 55 026	B	1,8	60	7.200	15764	5,82
30 x 1¼"		05 55 032	B	2,1	40	4.800	02403	6,60
40 x 1½"		05 55 040	B	2,4	30	3.600	02404	11,38
50 x 2"		05 55 050	B	2,7	20	2.400	02405	13,88
38 x 2"		05 55 051	B	2,0	20	2.400	02406	13,88
60 x 2½"		05 55 063	B	2,2	12	1.440	02407	18,89

UP. 55. SPIFT

C01 | ACP 050

**BOCCHETTONE PORTAGOMMA**

filetto femmina

SPIGOT UNION

BSP female thread

SIZE	PN	REF.	PACK	kg	Q(B)	Q(P)	CODE	EUR
16 x ¾"		05 55 416	B	3,6	100	12.000	02408	8,33
18 x ½"		05 55 418	B	3,6	90	10.800	02409	8,69
20 x ½"		05 55 420	B	2,4	60	7.200	02410	8,87
25 x ¾"		05 55 425	B	2,4	40	4.800	02411	9,79
30 x 1"		05 55 432	B	2,0	20	2.400	02412	11,73
40 x 1¼"		05 55 440	B	3,0	21	2.520	02413	14,88
50 x 1½"		05 55 450	B	2,2	10	1.200	02414	18,55
38 x 1½"		05 55 451	B	3,3	15	1.800	02415	18,55
60 x 2"		05 55 463	B	2,5	8	960	02416	23,94

UP. 55. SPIMT

C01 | ACP 050

**BOCCHETTONE PORTAGOMMA**

filetto maschio

SPIGOT UNION

BSP male thread

SIZE	PN	REF.	PACK	kg	Q(B)	Q(P)	CODE	EUR
16 x ¾"		05 55 616	B	2,8	80	9.600	02417	8,33
18 x ½"		05 55 618	B	3,0	80	9.600	02418	8,63
20 x ½"		05 55 620	B	3,0	80	9.600	02419	8,76
25 x ¾"		05 55 625	B	2,8	50	6.000	02420	9,14
30 x 1"		05 55 632	B	1,9	20	2.400	02421	10,51
40 x 1¼"		05 55 640	B	2,9	21	2.520	02422	13,63
50 x 1½"		05 55 650	B	2,1	10	1.200	02423	16,54
38 x 1½"		05 55 651	B	2,4	12	1.440	02424	16,54
60 x 2"		05 55 663	B	2,1	6	720	02425	22,24

UP. 56. SF

C01 | ACP 050

RACCORDO CONNESSIONE
FITTING CONNECTION

SIZE	PN	REF.	PACK	kg	Q(B)	Q(P)	CODE	EUR
40 x 2"	16	05 56 440	B	2,6	20	2.400	05350	10,24
50 x 2"	16	05 56 450	B	1,9	15	1.800	05351	13,84

CONNESSIONI VICTAULIC® - VICTAULIC® COUPLING

UP. 58. SFVT

C01 | ACP 010*

RACCORDO GIUNTO VICTAULIC®

incollaggio

GROOVED COUPLING SOCKET

solvent socket

SIZE	PN	REF.	PACK	kg	Q(B)	Q(P)	CODE	EUR
75 - 63 x 2"	16	05 58 463	B	2,6	16	1.920	20162	15,37
110 - 90 x 3"	16	05 58 490	C	4,1	8	480	20163	40,15
125 - 110 x 4"	16	05 58 510	D	8,5	12	360	20164	53,52
180 - 160 x 6"	10	05 58 560	D	6,2	4	120	21444	75,73

UP. 58. VT

C01 | ACP 100

GIUNTO VICTAULIC®
GROOVED COUPLING

SIZE	PN	REF.	PACK	kg	Q(B)	Q(P)	CODE	EUR
2"		05 58 063 *	B	9,6	12	720	20165	76,64
3"		05 58 090 *	B	9,7	8	480	20166	88,34
4"		05 58 110 *	B	7,1	4	240	20167	131,47
6"		05 58 160 *	C	12,6	4	120	21445	233,95

VISORI PER LIQUIDI - SIGHT GLASSES

UP. 54. SF

C01 | VCS 210

VISORE PER LIQUIDI

incollaggio

SIGHT GLASS

solvent socket

SIZE	PN	REF.	PACK	kg	Q(B)	Q(P)	CODE	EUR
50	6	05 54 050	C	4,8	12	720	02387	35,14
63	6	05 54 063	C	7,2	12	720	02388	43,48
75	10	05 54 075	C	7,4	3	180	02389	139,97
90	10	05 54 090	D	12,0	4	120	02390	182,29
110	10	05 54 110	D	8,0	2	60	02391	202,07
125	10	05 54 125	D	9,0	2	60	02392	238,75
140	10	05 54 140	D	5,5	1	30	02393	293,86
160	10	05 54 160	D	7,9	1	30	02394	445,81
200	10	05 54 200	E	10,0	1	15	02395	514,84
225	10	05 54 225	F	11,8	1	10	02396	610,83

UP. 54. FT

C01 | VCS 210

VISORE PER LIQUIDI

filetto femmina

SIGHT GLASS

BSP female thread

SIZE	PN	REF.	PACK	kg	Q(B)	Q(P)	CODE	EUR
1½"	6	05 54 650	C	4,8	12	720	02397	37,25
2"	6	05 54 663	C	7,8	12	720	02398	47,13

C01 | 007 999

PASSAPARETE IN PVC
BULKHEAD PVC FITTINGS

Alta resistenza al prodotto chimico.
Include 2 guarnizioni.

SIZE	PN	REF.	PACK	kg	Q(B)	Q(P)	CODE	EUR
1/2"	-	-	-	-	-	-	46975	48,01
3/4"	-	-	-	-	-	-	46976	54,84
1"	-	-	-	-	-	-	46977	61,92
1"1/4	-	-	-	-	-	-	46978	77,93
1"1/2	-	-	-	-	-	-	46979	91,39
2"	-	-	-	-	-	-	46980	107,12
3"	-	-	-	-	-	-	46981	250,06
4"	-	-	-	-	-	-	46982	598,97

C01 | 0007 999

ACCESSORI DI RIPARAZIONE
REPAIR FITTINGS

Fusione griglia in ghisa GG-22.
Viti bicromate gialle.
Tenuta EPDM.
Per PVC rigido.
Modello lungo.

SIZE	PN	REF.	PACK	kg	Q(B)	Q(P)	CODE	EUR
63	-	-	-	-	-	-	20543	41,01
75	-	-	-	-	-	-	20544	47,93
90	-	-	-	-	-	-	20545	56,38
110	-	-	-	-	-	-	20546	80,12
125	-	-	-	-	-	-	20547	92,85
140	-	-	-	-	-	-	20548	101,30
160	-	-	-	-	-	-	20549	127,03
200	-	-	-	-	-	-	20551	218,32
250	-	-	-	-	-	-	20552	322,72
315	-	-	-	-	-	-	20553	417,75

* Disponibilità su richiesta.
* Availability on order.

UP. 05. RJ

C01 | ACP 090

**MANICOTTO**

con guarnizione elastica

SOCKET

rubber ring joint

SIZE	PN	REF.	PACK	kg	Q(B)	Q(P)	CODE	EUR
63	10	70 05 063 *	C	2,3	6	360	22917-IT	33,48
75	10	70 05 075 *	D	4,9	9	270	22918-IT	39,70
90	10	70 05 090 *	D	4,6	6	180	22919-IT	52,19
110	10	70 05 110 *	E	9,2	8	120	22920-IT	66,82
125	10	70 05 125 *	E	10,5	7	105	22921-IT	94,31
140	10	70 05 140 *	E	9,4	5	75	22922-IT	109,71
160	10	70 05 160 *	E	7,0	3	45	22923-IT	144,85
200	10	70 05 200 *	F	10,0	2	20	22924-IT	239,74
225	10	70 05 225 *	G	13,7	2	20	22925-IT	332,90
250	10	70 05 250 *	G	15,3	2	20	22926-IT	447,32
315	10	70 05 315 *	1,452	102,2	6	6	22927-IT	785,85

Accessori PVC-U

Valvole PVC-U

Accessori PVC-C

Valvole PVC-C

Valvole Extreme

Evacuazione

Ricambi

FLUSSIMETRI - FLOWMETERS

UP. 92. SF. M

C01 | VCS 220

FLUSSIMETRO metacrilato
 incollaggio

FLOWMETER methacrylate
 solvent socket

SIZE	PN	REF.	PACK	kg	Q(B)	Q(P)	CODE	EUR
20 (10-100 l/h)	15	05 92 020A	B	0,6	4	480	20205	399,88
20 (16-160 l/h)	15	05 92 020B	B	0,6	4	480	20206	399,88
20 (25-250 l/h)	15	05 92 020C	B	0,6	4	480	20207	399,88
25 (40-400 l/h)	15	05 92 025A	B	1,0	4	480	20208	406,01
25 (60-630 l/h)	15	05 92 025B	B	1,0	4	480	20209	418,20
25 (100-1000 l/h)	15	05 92 025C	B	1,0	4	480	20210	418,20

UP. 92. FT. M

C01 | VCS 220

FLUSSIMETRO metacrilato
 filetto femmina

FLOWMETER methacrylate
 BSP female thread

SIZE	PN	REF.	PACK	kg	Q(B)	Q(P)	CODE	EUR
½" (10-100 l/h)	15	05 92 620A	B	0,6	4	480	20211	390,99
½" (16-160 l/h)	15	05 92 620B	B	0,6	4	480	20212	402,74
½" (25-250 l/h)	15	05 92 620C	B	0,6	4	480	20213	390,99
¾" (40-400 l/h)	15	05 92 625A	B	1,0	4	480	20214	408,73
¾" (60-630 l/h)	15	05 92 625B	B	1,0	4	480	20215	408,73
¾" (100-1000 l/h)	15	05 92 625C	B	1,0	4	480	20216	408,73

UP. 92. MT. M

C01 | VCS 220

FLUSSIMETRO metacrilato
 filetto maschio

FLOWMETER methacrylate
 BSP male thread

SIZE	PN	REF.	PACK	kg	Q(B)	Q(P)	CODE	EUR
½" (10-100 l/h)	15	05 92 420A	B	0,6	4	480	20217	402,74
½" (16-160 l/h)	15	05 92 420B	B	0,6	4	480	20218	402,74
½" (25-250 l/h)	15	05 92 420C	B	0,6	4	480	20219	402,74
¾" (40-400 l/h)	15	05 92 425A	B	1,1	4	480	20220	415,60
¾" (60-630 l/h)	15	05 92 425B	B	1,0	4	480	20221	415,60
¾" (100-1000 l/h)	15	05 92 425C	B	1,0	4	480	20222	415,60

UP. 92. FLG. M

C01 | VCS 220

FLUSSIMETRO metacrilato
 con flange

FLOWMETER methacrylate
 with flanges

SIZE	PN	REF.	PACK	kg	Q(B)	Q(P)	CODE	EUR
20 (10-100 l/h)	15	05 92 220A	B	1,0	3	360	20223	428,41
20 (16-160 l/h)	15	05 92 220B	B	1,0	3	360	20224	428,41
20 (25-250 l/h)	15	05 92 220C	B	1,0	3	360	20225	428,41
25 (40-400 l/h)	15	05 92 225A	B	1,1	2	240	20226	458,77
25 (60-630 l/h)	15	05 92 225B	B	1,1	2	240	20227	458,77
25 (100-1000 l/h)	15	05 92 225C	B	1,0	2	240	20228	458,77

ADESIVI/SOLVENTI - SOLVENT CEMENT/CLEANERS

UP. 90. SC

C02 | ADH 010



ADESIVO PVC-U

PVC-U SOLVENT CEMENT

SIZE	PN	REF.	PACK	kg	Q(B)	Q(P)	CODE	EUR
125 cc		05 90 012	0,02	5,1	30	1.260	02429	8,69
250 cc c/pen.		05 90 026	0,02	8,8	28	1.176	02430	23,45
500 cc		05 90 050	0,02	7,5	15	630	02427	25,79
500 cc c/pen.		05 90 051	0,02	7,6	15	630	09043	36,37
1.000 cc		05 90 100	0,02	12,5	12	504	02426	47,90
1.000 cc c/pen.		05 90 101	0,02	12,3	12	504	09044	66,66

UP. 90. SC. TV

C02 | ADH 010



ADESIVO PVC-U

c/tappo valvola

PVC-U SOLVENT CEMENT

w/cover valve

SIZE	PN	REF.	PACK	kg	Q(B)	Q(P)	CODE	EUR
1.000 cc		05 90 100 TV	0,02	12,5	12	504	60251	50,95

UP. 90. SCB

C02 | ADH 010



ADESIVO PVC-U BONDITITE

BONDITITE PVC-U SOLVENT CEMENT

SIZE	PN	REF.	PACK	kg	Q(B)	Q(P)	CODE	EUR
250 cc c/pen.		05 90 026B	0,02	10,0	36	1.728	68595	18,69
500 cc c/pen.		05 90 051B	0,02	13,5	24	720	68596	28,59
1.000 cc c/pen.		05 90 101B	0,02	13,3	12	576	68597	45,13

UP. 90. TSC

C02 | ADH 010



ADHESIVO PVC-U TANGIT®

TANGIT® PVC-U SOLVENT CEMENT

SIZE	PN	REF.	PACK	kg	Q(B)	Q(P)	CODE	EUR
125 cc			0,01	2,0	12		100490	25,42
250 cc c/pen.			0,015	4,0	12		100491	40,78
500 cc		05 90 350 *	0,014	7,6	12	864	02434-IT	70,12
1.000 cc		05 90 400 *	0,028	14,4	12	864	02433-IT	122,12

UP. 90. CL

C02 | ADH 010



SOLVENTE

CLEANER

PVC-U / CPVC

SIZE	PN	REF.	PACK	kg	Q(B)	Q(P)	CODE	EUR
500 cc		05 90 250	0,02	7,6	15	630	02432	17,91
1.000 cc		05 90 300	0,02	10,5	12	504	02431	28,24

UP. 90. SCU

C02 | ADH 010



ADESIVO GEL (PVC RIGIDO)

con applicatore

GEL PVC-U SOLVENT CEMENT

with brush

SIZE	PN	REF.	PACK	kg	Q(B)	Q(P)	CODE	EUR
125 cc		06 90 050 GEL	-	-	30	-	104051	10,41
250 cc c/pen.		06 90 250 GEL	-	-	24	-	104052	18,25
500 cc c/pen.		06 90 500 GEL	-	-	12	-	104053	32,52
1000 cc c/pen.		06 90 100 GEL	-	-	8	-	104054	51,28

C02



ADESIVO WDF-05

WDF-05 SOLVENT CEMENT

SIZE	PN	REF.	PACK	kg	Q(B)	Q(P)	CODE	EUR
500 cc c/pen.			0,02	6,7	12	672	D7007	44,85

UP. 90. TCL

C02 | ADH 010



SOLVENTE TANGIT®

TANGIT® CLEANER

SIZE	PN	REF.	PACK	kg	Q(B)	Q(P)	CODE	EUR
1000 cc		46 60 76	0,02	11,4	12	-	14213	80,53

KS. 90. TCL

C02 | ADH 010



TANGIT® KS

detergente giunzioni saldate

TANGIT® KS

cleaner for welded unions

SIZE	PN	REF.	PACK	kg	Q(B)	Q(P)	CODE	EUR
1 KG	-	-	0,03	-	8	-	100506	52,38

C02

SCIVOLANTE BLUE GEL

SIZE	PN	REF.	PACK	kg	Q(B)	Q(P)	CODE	EUR
80 gr	-	-	0,02	9,6	12	480	104057	33,98

BLUE GEL LUBRIFIANT

UL. 90. TF

C02 | ADH 010

TANGIT® UNI-LOCK

filo sigillaraccordi

SIZE	PN	REF.	PACK	kg	Q(B)	Q(P)	CODE	EUR
80 m	-	-	0,01	-	20	-	100505	40,41
160 m	-	-	0,01	-	20	-	101500	61,39

TANGIT® UNI-LOCK

thread sealant

UP. 90. SCHCR

C02 | ADH 010

ADESIVO PVC-U/PVC-C HCR-36

alta resistenza chimica

SIZE	PN	REF.	PACK	kg	Q(B)	Q(P)	CODE	EUR
1.000 cc	-	05 90 100 HCR *	C	8,1	6	360	52711	215,90

HCR-36 PVC-U/CPVC SOLVENT CEM.

high chemical resistance

CP. 90. SCH

C02 | ADH 010

ADESIVO PVC-C HT-120

con applicatore

SIZE	PN	REF.	PACK	kg	Q(B)	Q(P)	CODE	EUR	
500 cc c/pen	-	36 90 051 *		0,02	7,0	12	924	52708	85,16

HT-120 CPVC SOLVENT CEMENT

with brush

ABS. 90. SCW

C02 | ADH 010

ADESIVO ABS B-21 BLANCO

con applicatore

SIZE	PN	REF.	PACK	kg	Q(B)	Q(P)	CODE	EUR	
500 cc c/pen	-	37 90 051 BL *		0,02	6,0	12	720	52709	65,72

B-21 ABS WHITE SOLVENT CEMENT

with brush

UP. 90. TF

C02 | ADH 010

NASTRO PTFE

SIZE	PN	REF.	PACK	kg	Q(B)	Q(P)	CODE	EUR
12mm/12m/0,075	-	05 90 500 *	B	1,7	140	16.800	02435-IT	1,53
19mm/50m/0,15	-	05 90 550 *	B	3,0	36	4.320	02436N	8,57

PTFE THREAD-WRAP TAPE

TUBI PVC-U - PVC-U PIPE

TUBI SEMIRIGIDI PVC-U - PVC-U FLEXIBLE HOSES

Cepex presenta la gamma di tubi flessibili in PVC di alta qualità: flessibilità + leggerezza + robustezza.

Descrizione:

Tubi semirigidi in PVC-U con rinforzo spiralato interno e superfici esterne ed interne lisce.

Caratteristiche e qualità:

- Spirale rigida rinforzata: indeformabile e antiurto.
- Flessibile e leggero.
- Unione ermetica e resistente testata fino a 30 bar di pressione.
- Elevata resistenza alle acque di scarico e ad un'ampia gamma di prodotti chimici.
- Dimensioni e caratteristiche conformi alla EN ISO 3994.
- Marcatura d'identificazione ad ogni metro di tubo.

Temperature di esercizio:

Supporta temperature comprese tra -10°C e +60°C, sottovuoto fino a 7mca.

Applicazioni:

- scarichi,
- conduzione sanitaria,
- circuiti di depurazione piscina,
- idromassaggi,
- trattamento acque reflue ed in generale a tutte le applicazioni di conduzione di liquidi che necessitano di un' elevata resistenza all'abrasione.

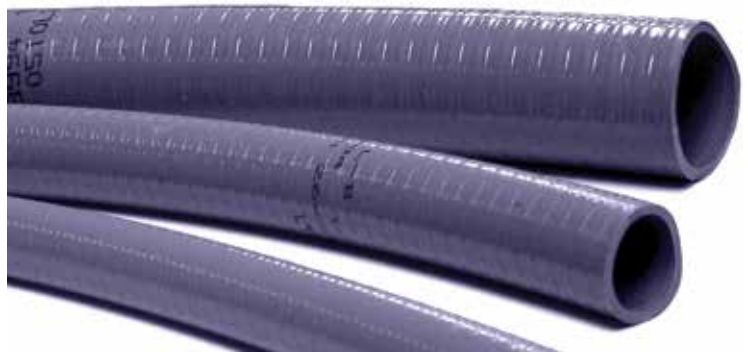

Unioni:

Si raccomandano unioni con l'impiego di:

Accessori PVC Cepex Collante Cepex Bondtite



È consentito anche l'utilizzo di accessori a compressione in PP Cepex Serie Performance; tali unioni consentono un rapido montaggio/smontaggio.

Accessori a compressione PP Cepex Serie Performance



UP.01.FLEX

T01 | TUB 010



TUBO SEMIRIGIDO PVC-U

PVC-U FLEXIBLE HOSE

SIZE	MAX PRESS.	REF.	PACK	kg	Q(B)	Q(P)	CODE	EUR
16	7	55 01 016	0,02	6,20	50 m	3600	34586	3,47
20	7	55 01 020	0,04	8,50	50 m	3300	28570	3,47
25	7	55 01 025	0,08	11,60	50 m	1000	28571	4,27
32	5	55 01 032	0,09	18,60	50 m	700	28572	6,39
40	5	55 01 040	0,14	22,90	50 m	550	28573	8,49
50	5	17 01 050	0,17	32	50 m	400	69856-IT	9,50
63	4	17 01 064	0,17	24	25 m	150	69858-IT	13,71
75	2,5	17 01 076	0,30	38	25 m	75	69859-IT	20,04

Colore: Grigio.

I diametri esterni predisposti per facilitare l'inserimento con accessori in PVC (unioni ad incollaggio) e in PP (unioni per compressione smontabili).

T01 | 045 010



TUBO SEMIRIGIDO PVC-U PLUS

PVC-U FLEXIBLE HOSE PLUS

SIZE	MAX PRESS.	REF.	PACK	kg	Q(B)	Q(P)	CODE	EUR
50	5	-	0,10	14	25 m	300	58612	11,10
50	5	-	0,23	36	50 m	450	58614	11,10
63	5	-	0,20	27	25 m	225	58618	15,76
63	5	-	0,36	54	50 m	300	58616	15,76

Colore: Bianco.

La superficie interna è rivestita in materiale PROTECT che gli conferisce una maggiore resistenza all'abrasione prodotta dalla sabbia e dai sedimenti presenti nel circuito. L'esclusiva sezione ovale del tubo semirigido conferisce una maggior resistenza fisica.

La pressione massima è riferita al normale impiego per l'aspirazione e lo scarico. In nessun caso è da considerarsi come pressione in uso continuo. The maximum pressure refers to common loading and unloading operations. It can never be used as pressure for continuous working.

TUBO FLESSIBILE SPIRALATO FITT B-ACTIVE

FITT B-ACTIVE FLEXIBLE HOSE

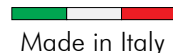

Cepex presenta il nuovo tubo flessibile per impianti di piscine interrate e spa FITT B-active: resistenza + garanzia + sicurezza. Questo prodotto infatti è in grado di offrire una "doppia" sicurezza con garanzia e copertura assicurativa decennale, grazie alle sue tecnologie brevettate e alla tracciabilità indelebile nel tempo. La scelta più sicura per installatori e rivenditori di piscine.

Descrizione:

FITT B-active è il tubo flessibile spiralato in PVC che risulta inattaccabile dalle sollecitazioni meccaniche e dagli stress chimici, rimane integro e funzionante anche in situazioni d'uso gravose. Progettazione e produzione Made in Italy.

Caratteristiche e qualità:



- Sicura tracciabilità. Marcatura sottostrato indelebile nel tempo.



- Sicura flessibilità. Il rivestimento della spirale rigida (Spiral Protection Barrier) fungendo da barriera, previene l'infragilimento precoce dovuto all'Environmental Stress Cracking (ESC).



- Sicura resistenza. La spirale con sezione D-Shape offre un'alta resistenza allo schiacciamento (fino a 34 kN/m²) che, combinata all'utilizzo di materiali di qualità superiore permette un'elevata flessibilità e un minore raggio di curvatura.



- Sicura protezione. La pellicola CDS (Chlorine Defence System) offre un'elevata protezione dall'acqua anche ad alto contenuto di cloro e dall'ambiente acido, garantendone la durabilità nel tempo.

Applicazioni:

- piscine interrate,
- spa.

Garanzia:

10 anni di garanzia e 10 anni di assicurazione*.

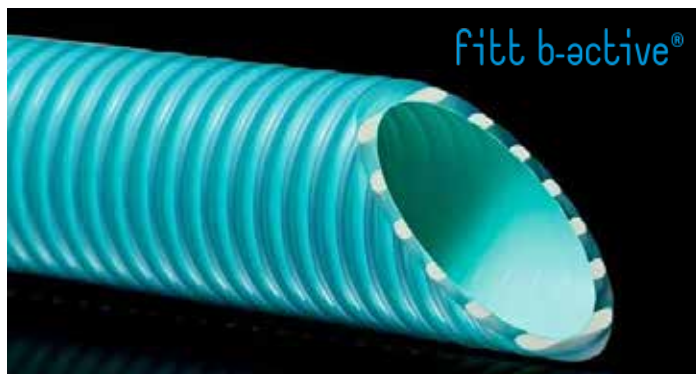

La qualità della materia prima utilizzata per FITT B-Active permette alte prestazioni in termini di sicurezza di incollaggio della raccorderia, oltre che conferire alla tubazione un'alta flessibilità.



Protezione e durata nel tempo



Intaccabilità al cloro



Posa sicura e ottimo raggio di curvatura

Certificazione:

Riconosciuto a livello globale, il certificato TÜV SÜD viene rilasciato al completamento di un intenso programma di test e verifiche e prevede un importante piano di ispezioni periodiche sulla produzione in corso, a garanzia del mantenimento degli alti standard di qualità raggiunti.



T01



TUBO FLESSIBILE SPIRALATO B-ACTIVE

B-ACTIVE FLEXIBLE HOSE

Colore: Azzurro.

SIZE	PN	REF.	PACK	kg	Q(B)	Q(P)	CODE	EUR
50	6	-	0,11	20	25 m	300	69860-IT	13,22
50	6	-	0,17	38	50 m	400	69861-IT	13,22
63	4	-	0,17	25,50	25 m	150	69862-IT	16,54

* Vedi certificato di garanzia e relative prescrizioni di posa.

Accessori PVC-U

Valvole PVC-U

Accessori PVC-C

Valvole PVC-C

Valvole Extreme

Evacuazione

Ricambi

TUBO PVC-U RIGIDO PER PRESSIONE

PVC-U PRESSURE PIPE

Descrizione:

Tubo in PVC-U rigido per condotte di fluidi in pressione. Ideale per la realizzazione di sistemi di convogliamento fluidi in pressione fuoriterza ed interrate.

Caratteristiche:

- lunghezza standard di 6 m.
- Estremità delle giunzioni lisce.

Applicazioni:

- piscine,
- irrigazione,
- industria,
- acquedottistica,
- acque reflue,
- fluidi alimentari.

Temperature di esercizio:

In funzione alle temperature, le pressioni di esercizio variano come indicato nella tabella a fianco. In accordo alla DIN 8061-62 UNI EN ISO 1452-2.

Certificazioni:

CSTB (NF EN 1452-2), DVGW, WRAS.

Il tubo è conforme alla norma UNI EN ISO 1452-2 per il trasporto di fluidi in pressione per adduzione di acqua potabile, irrigazione ed acque reflue a marchio IIP conforme al D.M.174 del 06/04/2004 (acque destinate al consumo umano), al D.M. del 21/03/1973 (fluidi alimentari: olio, vino, latte) e secondo la norma EN 1622 - analisi dell'acqua - determinazione della soglia di odore (TON) e della soglia di sapore (TFN).



Temperatura °C	Pressione di esercizio bar	
	PN 10	PN16
20	10	16
40	6	8
60	2	3



T02 | 008 010



TUBO PVC RIGIDO PER PRESSIONE

PVC PRESSURE PIPE

Colore: RAL 7011 Grigio scuro

Fornito in barre lisce da 3 o 6 metri, da PN10 - PN 16 - PN 20 bar.

Esempio: 23141 barra da 6 metri.
23141/3 barra da 3 metri.

PN 20 bar

PN 16 bar

PN 10 bar

D EST. mm	PESO BARRA DA 6 m	SPESS. mm	CODE	EUR / m
16	0,15	1,5	23141	1,47
20	0,97	1,5	13083	1,81
25	1,36	1,9	13084	2,74
32	2,20	2,4	13091	3,16
40	3,62	3,0	100266	4,52
50	5,05	3,7	13079	6,96
63	8,86	4,7	13082	11,12
75	12,29	5,6	13077	16,10
90	17,57	6,7	100263	20,70
110	19,92	6,6	100262	25,40
125	25,38	7,4	100267	33,09
140	44,11	8,3	13089	40,65
32	1,54	1,6	13090	2,42
40	2,33	1,9	13092	3,15
50	3,78	2,4	13078	4,99
63	5,63	3,0	13080	7,54
75	8,04	3,6	13085	10,60
90	11,44	4,3	13086	13,99
110	17,76	4,2	13087	18,48
125	22,74	4,8	13088	23,76
140	26,47	5,4	13097	29,95
160	37,37	6,2	13094	39,29
200	55,33	7,7	13095	60,73
225	75,81	8,6	13096	76,31
250	92,29	9,6	23142	94,66
315	116,38	12,1	13099	151,05

VALVOLE PER ACQUA PVC-U

PVC-U WATER VALVES

Accessori PVC-U

Valvole PVC-U

Accessori PVC-C

Valvole PVC-C

Valvole Extreme

Evacuazione

Ricambi

49 | Valvole a sfera PVC-U [STD]
PVC-U ball valves [STD]



52 | Valvole a sfera PVC-U [STANDARD]
PVC-U ball valves [STANDARD]



54 | Valvole a sfera PVC-U [INDUSTRIAL]
PVC-U Ball valves [INDUSTRIAL]



57 | Valvole a sfera [E-QUA]
Ball valves [E-QUA]



57 | Valvole a sfera [PN10]
Ball valves [PN10]



59 | Valvole a sfera [UNIBLOCK]
Ball valves [UNIBLOCK]



60 | Valvole a sfera [3 VIE]
Ball valves [3-WAY]



61 | Valvole di ritegno Molla
Check valves Spring



63 | Valvole di ritegno Sfera
Check valves Ball Series



65 | Valvole a clapet
Swing check valves



66 | Valvole a farfalla [STANDARD]
Butterfly valves Standard Series



67 | Valvole a farfalla [CLASSIC]
Butterfly valves [CLASSIC]



68 | Valvole a farfalla [INDUSTRIAL]
Butterfly valves [INDUSTRIAL]



69 | Valvole selettrici in PVC-U
PVC-U Rotary disc valves



69 | Valvole di spurgo
Drain valves



70 | Valvole a ghigliottina
Knife gate valves



72 | Valvole a sede inclinata
Angle seat valves



73 | Valvole di sfiato aria in PVC-U
PVC-U Air/vacuum relief valves



74 | Valvole a sfera attuate
Actuated ball valves



75 | Valvole a farfalla attuate
Actuated butterfly valves



77 | Ricambi ed accessori
per valvole attuate
Spare parts for actuated valves



DISTINTIVO MANIGLIA

 PE-EPDM

 PTFE-EPDM

 PTFE-FPM

VALVOLE A SFERA IN PVC-U SERIE STD - PVC-U BALL VALVES STD SERIES

UP. 60ST. SF5

C03 | VAL 311



PE - EPDM
incollaggio

PE - EPDM
solvent socket



SIZE	PN	REF.	PACK	kg	Q(B)	Q(P)	CODE	EUR
16	16	60 60 016	B	3,2	24 (12)	2880	36500	16,06
20	16	60 60 020	B	3,1	24 (12)	2880	36501	16,06
25	16	60 60 025	B	2,2	10 (5)	1200	36502	18,53
32	16	60 60 032	B	2,7	8	960	36503	24,73
40	16	60 60 040	B	2,9	6	720	36504	28,87
50	16	60 60 050	C	7,0	10	600	36505	38,40
63	16	60 60 063	D	12,1	10	300	36506	52,54
75	10	60 60 075	D	9,2	4 (1)	120	36507	191,04
90	10	60 60 090	D	7,2	2 (1)	60	36508	223,83
110	10	60 60 111	D	8,2	1	30	36509	400,07

UP. 60ST. FT5

C03 | VAL 311



PE - EPDM
filetto femmina

PE - EPDM
BSP female thread



SIZE	PN	REF.	PACK	kg	Q(B)	Q(P)	CODE	EUR
3/8"	16	60 60 616	B	3,2	24 (12)	2880	36510	17,94
1/2"	16	60 60 620	B	3,1	24 (12)	2880	36511	17,94
3/4"	16	60 60 625	B	2,2	10 (5)	1200	36512	19,69
1"	16	60 60 632	B	2,6	8	960	36513	26,15
1 1/4"	16	60 60 640	B	2,9	6	720	36514	30,27
1 1/2"	16	60 60 650	C	7,3	10	600	36515	40,61
2"	16	60 60 663	D	12,5	10	300	36516	59,84
2 1/2"	10	60 60 675	D	9,2	4 (1)	120	36517	200,12
3"	10	60 60 690	D	7,4	2 (1)	60	36518	232,64
4"	10	60 60 711	D	8,0	1	30	36519	422,49

UP. 61ST. SF6

C03 | VAL 311



PTFE - EPDM
incollaggio

PTFE - EPDM
solvent socket



SIZE	PN	REF.	PACK	kg	Q(B)	Q(P)	CODE	EUR
16	16	60 61 016	B	3,2	24 (12)	2880	41866	19,95
20	16	60 61 020	B	3,1	24 (12)	2880	37039	19,95
25	16	60 61 025	B	2,2	10 (5)	1200	37040	24,28
32	16	60 61 032	B	2,7	8	960	37041	32,39
40	16	60 61 040	B	2,9	6	720	37042	40,87
50	16	60 61 050	C	7,1	10	600	37043	55,31
63	16	60 61 063	D	12,2	10	300	37044	72,68
75	10	60 61 075	D	9,2	4 (1)	120	37045	220,46
90	10	60 61 090	D	7,2	2 (1)	60	41867	255,47
110	10	60 61 111	D	8,3	1	30	41868	525,07

UP. 61ST. FT6

C03 | VAL 311



PTFE - EPDM
filetto femmina

PTFE - EPDM
BSP female thread



SIZE	PN	REF.	PACK	kg	Q(B)	Q(P)	CODE	EUR
3/8"	16	60 61 616	B	3,4	24 (12)	2880	41869	21,19
1/2"	16	60 61 620	B	3,1	24 (12)	2880	37047	21,19
3/4"	16	60 61 625	B	2,2	10 (5)	1200	37048	25,00
1"	16	60 61 632	B	2,7	8	960	37049	33,69
1 1/4"	16	60 61 640	B	2,9	6	720	37050	42,55
1 1/2"	16	60 61 650	C	7,3	10	600	37051	56,40
2"	16	60 61 663	D	12,6	10	300	37052	74,46
2 1/2"	10	60 61 675	D	9,2	4 (1)	120	37053	227,08
3"	10	60 61 690	D	7,5	2 (1)	60	41870	264,42
4"	10	60 61 711	D	8,3	1	30	41871	575,93

VALVOLE A SFERA IN PVC-U SERIE STD - PVC-U BALL VALVES STD SERIES
UP. 60ST. SF7

C03 | VAL 311

PTFE - FPM
 incollaggio

PTFE - FPM
 solvent socket

SIZE	PN	REF.	PACK	kg	Q(B)	Q(P)	CODE	EUR
16	16	60 61 016 VI	B	3,1	24 (12)	2880	57725	36,11
20	16	60 61 020 VI	B	3,2	24 (12)	2880	57724	36,11
25	16	60 61 025 VI	B	2,2	10 (5)	1200	57726	41,51
32	16	60 61 032 VI	B	2,7	8	960	57727	55,05
40	16	60 61 040 VI	B	3,1	6	720	57728	69,49
50	16	60 61 050 VI	C	7,0	10	600	57729	96,78
63	16	60 61 063 VI	D	12,2	10	300	57730	119,93
75	10	60 61 075 VI	D	9,2	4 (1)	120	57731	291,01
90	10	60 61 090 VI	D	8,0	2 (1)	60	57732	324,43
110	10	60 61 111 VI	D	8,2	1	30	57733	567,08

UP. 60ST. FT7

C03 | VAL 311

PTFE - FPM
 filetto femmina

PTFE - FPM
 BSP female thread

SIZE	PN	REF.	PACK	kg	Q(B)	Q(P)	CODE	EUR
3/8"	16	60 61 616 VI	B	3,4	24 (12)	2880	57734	37,20
1/2"	16	60 61 620 VI	B	3,5	24 (12)	2880	57735	37,20
3/4"	16	60 61 625 VI	B	2,5	10 (5)	1200	57736	42,75
1"	16	60 61 632 VI	B	2,7	8	960	57737	56,70
1 1/4"	16	60 61 640 VI	B	3,0	6	720	57738	71,59
1 1/2"	16	60 61 650 VI	C	7,7	10	600	57739	99,68
2"	16	60 61 663 VI	D	13,2	10	300	57740	123,53
2 1/2"	10	60 61 675 VI	D	9,9	4 (1)	120	57741	299,74
3"	10	60 61 690 VI	D	8,5	2 (1)	60	57742	334,18
4"	10	60 61 711 VI	D	8,8	1	30	57743	584,10

UP. 60ST. PESF5

C03 | VAL 311

PE - EPDM
 connessione PE e incollaggio

PE - EPDM
 PE connection x solvent socket

SIZE	PN	REF.	PACK	kg	Q(B)	Q(P)	CODE	EUR
20 - 20	10	60 63 020	B	2,4	16 (8)	1920	43535	22,80
25 - 25	10	60 63 025	B	3,0	11	1320	43536	27,85
32 - 32	10	60 63 032	B	2,7	6	960	43537	36,13
40 - 40	10	60 63 040	C	6,4	10	600	43538	40,14
50 - 50	10	60 63 050	C	5,5	6	360	43539	51,01
63 - 63	10	60 63 063	D	12,6	8	240	43540	77,74

UP. 60ST. PEFT5

C03 | VAL 311

PE - EPDM
 connessione PE e filetto femmina

PE - EPDM
 PE connection x BSP female thread

SIZE	PN	REF.	PACK	kg	Q(B)	Q(P)	CODE	EUR
20 - 1/2"	10	60 63 420	B	2,6	16 (8)	1920	43541	23,19
25 - 3/4"	10	60 63 425	B	3,0	11	1320	43542	28,22
32 - 1"	10	60 63 432	B	2,9	7	840	43543	36,68
40 - 1 1/4"	10	60 63 440	C	6,4	10	600	43544	41,06
50 - 1 1/2"	10	60 63 450	C	5,6	6	360	43545	52,33
63 - 2"	10	60 63 463	D	12,9	8	240	43546	78,33

UP. 60ST. PE5

C03 | VAL 311

PE - EPDM
 connessione a PE

PE - EPDM
 PE connection x PE connection

SIZE	PN	REF.	PACK	kg	Q(B)	Q(P)	CODE	EUR
20	10	60 63 620	B	2,5	14 (7)	1680	43547	28,32
25	10	60 63 625	B	2,9	9	1080	43548	35,98
32	10	60 63 632	B	2,3	5	600	43549	45,30
40	10	60 63 640	C	5,5	7	420	45290	50,48
50	10	60 63 650	C	5,7	5	300	43551	67,63
63	10	60 63 663	D	11,7	6	180	43552	102,82

UP. 60ST. BW11

C03 | VAL311

PE - EPDM
 saldatura testa a testa

PE - EPDM
 PE100

SIZE	PN	REF.	PACK	kg	Q(B)	Q(P)	CODE	EUR
20	16	60 60 220 PE	B	1,6	10 (5)	1200	44755	24,84
25	16	60 60 225 PE	B	2,2	10	1200	44756	27,26
32	16	60 60 232 PE	C	4,7	14	840	44757	34,08
40	16	60 60 240 PE	C	3,8	8	480	44758	38,89
50	16	60 60 250 PE	C	4,3	6	360	44759	63,20
63	16	60 60 263 PE	D	7,6	6	180	44760	80,29
75	10	60 60 275 PE	D	8,7	4	120	44761	210,05
90	10	60 60 290 PE	D	7,5	2	60	44762	294,52
110	10	60 60 311 PE	D	7,9	1	30	44763	545,70

CONNESSIONI VALVOLE A SFERA SERIE STD - BALL VALVE END CONNECTORS STD SERIES
UP. 22ST. SM. VA

C03 | VAL 325

MANICOTTO VALVOLA A SFERA [STD]
 incollaggio maschio PVC-U

[STD] BALL VALVE END CONNECTOR
 PVC-U male solvent socket

SIZE	PN	REF.	PACK	kg	Q(B)	Q(P)	CODE	EUR
20	16	60 22 220 VA	B	1,8	120 (10)	14400	65023	3,62
25	16	60 22 225 VA	B	2,2	90	10800	65024	3,81
32	16	60 22 232 VA	B	2,8	80	9600	65025	4,78
40	16	60 22 240 VA	B	2,2	40	4800	65026	5,36
50	16	60 22 250 VA	C	4,4	50	3000	65027	6,30
63	16	60 22 263 VA	C	5,4	36	2160	65028	10,71
75	10	60 22 275 VA	D	8,4	36	1080	65029	17,48
90	10	60 22 290 VA	D	8,7	24	720	65030	21,47
110	10	05 22 311 VA	D	6,3	8 (2)	240	33732	32,64

UP. 22ST. MT. VA

C03 | VAL 325

MANICOTTO VALVOLA A SFERA [STD]
 incollaggio maschio PVC-U

[STD] BALL VALVE END CONNECTOR
 PVC-U male thread

SIZE	PN	REF.	PACK	kg	Q(B)	Q(P)	CODE	EUR
3/8"	16	60 22 416 VA	B	1,6	120 (10)	14400	64317	3,88
1/2"	16	60 22 420 VA	B	1,8	120 (10)	14400	64404	3,88
3/4"	16	60 22 425 VA	B	2,2	100 (10)	12000	64405	4,17
1"	16	60 22 432 VA	B	2,9	80	9600	64406	4,86
1"1/4	16	60 22 440 VA	B	2,9	50	6000	64407	6,26
1"1/2	16	60 22 450 VA	C	4,9	60	3600	64408	6,86
2"	16	60 22 463 VA	C	3,6	1	60	64409	11,63
2"1/2	10	60 22 475 VA	D	7,4	24 (4)	720	64410	24,74
3"	10	60 22 490 VA	C	4,2	8	480	64411	30,89
4"	10	05 22 511 VA	D	6,5	8 (2)	240	33733	45,79

PE. 21ST. BW11. VA

C03 | APE 063

MANICOTTO VALVOLA A SFERA [STD]
 PE100

[STD] BALL VALVE END CONNECTOR
 PE100

SIZE	PN	REF.	PACK	kg	Q(B)	Q(P)	CODE	EUR
20	16	60 45 020 VA	B	1,3	120	14400	55175	10,36
25	16	60 45 025 VA	B	1,3	80	9600	55176	11,34
32	16	60 45 032 VA	B	1,6	60	7200	55177	11,98
40	16	60 45 040 VA	B	1,3	30	3600	55178	13,05
50	16	60 45 050 VA	C	2,9	40	2400	55179	17,62
63	16	60 45 063 VA	D	6,8	50	1500	55180	20,61
75	10	60 45 075 VA	D	5,3	24	720	55181	30,38

UP. 23ST. PE. VA

C03 | VAL 325

MANICOTTO VALVOLA A SFERA [STD]
 connessione PE

[STD] BALL VALVE END CONNECTOR
 PP - PE connection

SIZE	PN	REF.	PACK	kg	Q(B)	Q(P)	CODE	EUR
16	10	60 23 416 VA	-	-	-	-	57292	10,53
20	10	60 23 420 VA	-	-	-	-	55184	10,53
25	10	60 23 425 VA	-	-	-	-	55946	13,78
32	10	60 23 432 VA	-	-	-	-	55947	16,33
40	10	60 23 440 VA	-	-	-	-	55948	19,18
50	10	60 23 450 VA	D	15,2	36	1080	55949	28,12
63	10	60 23 463 VA	D	12,5	18	540	55950	43,02

Conneessioni compatibili con le valvole a sfera Cepex Serie STD (pag. 47 e 48). Non compatibili con il modello della valvola Standard o Industrial.
 End connectors compatible with the Cepex STD Series (pag. 47 and 48). Not compatible with the valve model Standard or Industrial.

VALVOLE A SFERA IN PVC-U SERIE STANDARD - PVC-U BALL VALVES STANDARD SERIES

UP. 60. SF5

C03 | VAL 310

PE - EPDM
incollaggio

PE - EPDM
solvent socket

SIZE	PN	REF.	PACK	kg	Q(B)	Q(P)	CODE	EUR
16	16	05 60 016	B	3,7	24 (12)	2880	05352	18,05
20	16	05 60 020	B	3,6	24 (12)	2880	02453	18,05
25	16	05 60 025	B	2,5	10 (5)	1200	02454	20,86
32	16	05 60 032	B	2,9	8	960	02455	27,83
40	16	05 60 040	B	3,5	6	720	02456	32,47
50	16	05 60 050	C	5,5	6	360	02457	44,01
63	16	05 60 063	D	13,2	9	270	02458	60,24
75	10	05 60 075	D	10,6	4 (1)	120	02459	214,89
90	10	05 60 090	D	8,2	2 (1)	60	02460	292,76
110 (DN 80)	10	05 60 110	D	8,7	2 (1)	60	02461	311,59
110	10	05 60 111	D	8,4	1	30	22797	487,42
125 (DN 100)	10	05 60 125	D	8,3	1	30	23084	509,13

UP. 60. FT5

C03 | VAL 310

PE - EPDM
filetto femmina

PE - EPDM
BSP female thread

SIZE	PN	REF.	PACK	kg	Q(B)	Q(P)	CODE	EUR
3/8"	16	05 60 616	B	3,7	24 (12)	2880	05353	20,16
1/2"	16	05 60 620	B	3,6	24 (12)	2880	02462	20,16
3/4"	16	05 60 625	B	2,5	10 (5)	1200	02463	22,15
1"	16	05 60 632	B	2,9	8	960	02464	29,41
1 1/4"	16	05 60 640	B	3,5	6	720	02465	34,02
1 1/2"	16	05 60 650	C	5,7	6	360	02466	46,57
2"	16	05 60 663	D	13,7	9	270	02467	63,66
2 1/2"	10	05 60 675	D	10,9	4 (1)	120	02468	227,00
3"	10	05 60 690	D	8,4	2 (1)	60	02469	308,90
4" (DN 80)	10	05 60 710	D	8,6	2 (1)	60	05354	327,68
4"	10	05 60 711	D	8,4	1	30	22798	499,85

UP. 61. SF6

C03 | VAL 310

PTFE - EPDM
incollaggio

PTFE - EPDM
solvent socket

SIZE	PN	REF.	PACK	kg	Q(B)	Q(P)	CODE	EUR
16	16	05 61 016	B	3,8	24 (12)	2880	05355	19,32
20	16	05 61 020	B	3,7	24 (12)	2880	02470	19,32
25	16	05 61 025	B	2,5	10 (5)	1200	02471	23,29
32	16	05 61 032	B	3,0	8	960	02472	32,47
40	16	05 61 040	B	3,5	6	720	02473	38,60
50	16	05 61 050	C	5,6	6	360	02474	51,15
63	16	05 61 063	D	13,2	9	270	02475	68,45
75	10	05 61 075	D	10,9	4 (1)	120	02476	221,89
90	10	05 61 090	D	8,4	2 (1)	60	02477	303,50
110 (DN 80)	10	05 61 110	D	8,7	2 (1)	60	05356	323,64
110	10	05 61 111	D	8,5	1	30	22065	643,95

UP. 61. FT6

C03 | VAL 310

PTFE - EPDM
filetto femmina

PTFE - EPDM
BSP female thread

SIZE	PN	REF.	PACK	kg	Q(B)	Q(P)	CODE	EUR
3/8"	16	05 61 616	B	3,8	24 (12)	2880	05357	20,16
1/2"	16	05 61 620	B	3,7	24 (12)	2880	02478	20,16
3/4"	16	05 61 625	B	2,6	10 (5)	1200	02479	24,08
1"	16	05 61 632	B	3,0	8	960	02480	34,02
1 1/4"	16	05 61 640	B	3,6	6	720	02481	40,12
1 1/2"	16	05 61 650	C	5,7	6	360	02482	53,40
2"	16	05 61 663	D	13,7	9	270	02483	71,59
2 1/2"	10	05 61 675	D	11,0	4 (1)	120	02484	235,03
3"	10	05 61 690	D	8,6	2 (1)	60	02485	324,06
4" (DN 80)	10	05 61 710	D	8,6	2 (1)	60	05358	338,03
4"	10	05 61 711	D	8,4	1	30	22066	653,69

Accessori PVC-U

Valvole PVC-U

Accessori PVC-C

Valvole PVC-C

Valvole Extreme

Evacuazione

Ricambi

VALVOLE A SFERA IN PVC-U SERIE STANDARD - PVC-U BALL VALVES STANDARD SERIES

UP. 61. SF7

C03 | VAL 310



PTFE - FPM
incollaggio

PTFE - FPM
solvent socket



SIZE	PN	REF.	PACK	kg	Q(B)	Q(P)	CODE	EUR
16	16	05 61 016 VI	B	3,8	24 (12)	2880	05359	38,86
20	16	05 61 020 VI	B	3,7	24 (12)	2880	02486	38,86
25	16	05 61 025 VI	B	2,6	10 (5)	1200	02487	42,64
32	16	05 61 032 VI	B	3,0	8	960	02488	57,34
40	16	05 61 040 VI	B	3,6	6	720	02489	63,17
50	16	05 61 050 VI	C	5,6	6	360	02490	94,87
63	16	05 61 063 VI	D	13,5	9	270	02491	113,08
75	10	05 61 075 VI	D	10,9	4 (1)	120	02492	281,25
90	10	05 61 090 VI	D	8,3	2 (1)	60	02493	358,59
110 (DN 80)	10	05 61 110 VI	D	8,7	2 (1)	60	05360	381,76
110	10	05 61 111 VI	D	8,4	1	30	26442	686,28

UP. 61. FT7

C03 | VAL 310



PTFE - FPM
filetto femmina

PTFE - FPM
BSP female thread



SIZE	PN	REF.	PACK	kg	Q(B)	Q(P)	CODE	EUR
3/8"	16	05 61 616 VI	B	3,8	24 (12)	2880	05361	39,86
1/2"	16	05 61 620 VI	B	3,7	24 (12)	2880	02494	39,86
3/4"	16	05 61 625 VI	B	2,6	10 (5)	1200	02495	43,46
1"	16	05 61 632 VI	B	3,0	8	960	02496	58,61
1 1/4"	16	05 61 640 VI	B	3,6	6	720	02497	64,44
1 1/2"	16	05 61 650 VI	C	5,8	6	360	02498	96,26
2"	16	05 61 663 VI	D	14,0	9	270	02499	113,90
2 1/2"	10	05 61 675 VI	D	11,0	4 (1)	120	02500	286,27
3"	10	05 61 690 VI	D	8,4	2 (1)	60	02501	306,09
4" (DN 80)	10	05 61 710 VI	D	8,6	2 (1)	60	05362	371,98
4"	10	05 61 711 VI	D	8,4	1	30	26443	696,16

VALVOLE A SFERA IN PVC-U SERIE INDUSTRIAL - PVC-U BALL VALVES INDUSTRIAL SERIES

UP. 73. SF6

C03 | VAL 315

PTFE - EPDM
incollaggio

PTFE - EPDM
solvent socket

SIZE	PN	REF.	PACK	kg	Q(B)	Q(P)	CODE	EUR
16	16	05 73 016	B	1,4	8 (1)	960	18434	28,63
20	16	05 73 020	B	1,3	8 (1)	960	18435	29,81
25	16	05 73 025	B	2,1	8 (1)	960	18436	34,04
32	16	05 73 032	B	1,6	4 (1)	480	18437	41,06
40	16	05 73 040	B	2,4	4 (1)	480	18438	55,11
50	16	05 73 050	D	7,4	8 (1)	240	18439	67,88
63	16	05 73 063	D	8,8	6 (1)	180	18440	87,54
75	10	05 73 075	D	10,9	4 (1)	120	18441	244,42
90	10	05 73 090	D	8,4	2 (1)	60	18442	297,57
110	10	05 73 111	D	8,5	1	30	22799	565,26

UP. 73. FT6

C03 | VAL 315

PTFE - EPDM
filetto femmina

PTFE - EPDM
BSP female thread

SIZE	PN	REF.	PACK	kg	Q(B)	Q(P)	CODE	EUR
3/8"	16	05 73 616	B	1,3	8 (1)	960	18453	29,62
1/2"	16	05 73 620	B	1,3	8 (1)	960	18454	30,53
3/4"	16	05 73 625	B	2,1	8 (1)	960	18455	35,18
1"	16	05 73 632	B	1,6	4 (1)	480	18456	42,72
1 1/4"	16	05 73 640	B	2,4	4 (1)	480	18457	57,36
1 1/2"	16	05 73 650	D	7,6	8 (1)	240	18458	70,83
2"	16	05 73 663	D	9,4	6 (1)	180	18459	91,13
2 1/2"	10	05 73 675	D	10,9	4 (1)	120	18460	254,76
3"	10	05 73 690	D	8,5	2 (1)	60	18461	308,74
4"	10	05 73 711	D	8,4	1	30	22800	577,81

UP. 69. FLG6

C03 | VAL 315

PTFE - EPDM
con flange

PTFE - EPDM
with flanges

SIZE	PN	REF.	PACK	kg	Q(B)	Q(P)	CODE	EUR
20	16	05 69 220	B	2,1	6	720	07733	46,19
25	16	05 69 225	B	2,7	5	600	07734	53,14
32	16	05 69 232	B	1,5	2 (1)	240	07735	63,16
40	16	05 69 240	B	2,3	2	240	07736	80,62
50	16	05 69 250	B	1,6	1	120	07737	97,36
63	16	05 69 263	B	2,4	1	120	07738	123,83
75	10	05 69 275	D	7,3	2 (1)	60	07739	308,33
90	10	05 69 290	D	11,7	2 (1)	60	07740	394,47
110 (DN 80)	10	05 69 310	D	6,6	1	30	07741	621,09
110	10	05 69 311	D	10,8	1	30	34592	659,54

UP. 73. SF7

C03 | VAL 315

PTFE - FPM
incollaggio

PTFE - FPM
solvent socket

SIZE	PN	REF.	PACK	kg	Q(B)	Q(P)	CODE	EUR
16	16	05 73 016 VI	B	1,4	8 (1)	960	18444	42,89
20	16	05 73 020 VI	B	1,3	8 (1)	960	18445	44,01
25	16	05 73 025 VI	B	2,1	8 (1)	960	18670	51,01
32	16	05 73 032 VI	B	1,6	4 (1)	480	18446	63,44
40	16	05 73 040 VI	B	2,5	4 (1)	480	18447	80,12
50	16	05 73 050 VI	D	7,6	8 (1)	240	18448	105,46
63	16	05 73 063 VI	D	9,2	6 (1)	180	18449	130,72
75	10	05 73 075 VI	D	10,9	4 (1)	120	18450	294,88
90	10	05 73 090 VI	D	8,3	2 (1)	60	18451	354,08
110	10	05 73 111 VI	D	8,4	1	30	22801	662,79

UP. 73. FT7

C03 | VAL 315

PTFE - FPM
filetto femmina

PTFE - FPM
BSP female thread

SIZE	PN	REF.	PACK	kg	Q(B)	Q(P)	CODE	EUR
3/8"	16	05 73 616 VI	B	1,4	8 (1)	960	18463	43,75
1/2"	16	05 73 620 VI	B	1,3	8 (1)	960	18464	44,93
3/4"	16	05 73 625 VI	B	2,2	8 (1)	960	18465	52,19
1"	16	05 73 632 VI	B	1,6	4 (1)	480	18466	64,32
1 1/4"	16	05 73 640 VI	B	2,4	4 (1)	480	18467	82,26
1 1/2"	16	05 73 650 VI	D	7,1	8 (1)	240	18468	108,03
2"	16	05 73 663 VI	D	9,5	6 (1)	180	18469	134,43
2 1/2"	10	05 73 675 VI	D	10,9	4 (1)	120	18470	307,82
3"	10	05 73 690 VI	D	8,5	2 (1)	60	18471	365,20
4"	10	05 73 711 VI	D	8,5	1	30	22802	675,29

**CONNESSIONI VALVOLE A SFERA PVC-U SERIE STANDARD E INDUSTRIAL -
PVC-U BALL VALVE END CONNECTORS STANDARD & INDUSTRIAL SERIES**

UP. 22. SM. VA

C03 | VAL 325

**PEZZO FOLLE**

incollaggio maschio PVC-U

BALL VALVE END CONNECTOR

PVC-U male solvent socket

SIZE	PN	REF.	PACK	kg	Q(B)	Q(P)	CODE	EUR
16	16	05 22 216 VA	B	1,5	120 (10)	14400	33731	2,80
20	16	05 22 220 VA	B	1,9	120 (10)	14400	20178	2,80
25	16	05 22 225 VA	B	2,2	90	10800	20179	3,07
32	16	05 22 232 VA	B	2,9	80	9600	20180	3,35
40	16	05 22 240 VA	B	2,2	40	4800	20190	3,83
50	16	05 22 250 VA	C	4,5	50	3000	20191	4,35
63	16	05 22 263 VA	C	6,1	36	2160	20192	8,03
75	10	05 22 275 VA	C	2,9	12	720	20193	11,40
90	10	05 22 290 VA	C	3,7	10 (2)	600	20194	14,66
110 (DN 80)	10	05 22 310 VA	D	4,5	8 (2)	240	20195	21,89
110	10	05 22 311 VA	D	6,3	8 (2)	240	33732	32,64

UP. 22. MT. VA

C03 | VAL 325

**PEZZO FOLLE**

filetto maschio PVC-U

BALL VALVE END CONNECTOR

PVC-U BSP male thread

SIZE	PN	REF.	PACK	kg	Q(B)	Q(P)	CODE	EUR
¾"	10	05 22 416 VA	B	1,7	120 (10)	14400	33691	3,51
½"	10	05 22 420 VA	B	1,8	120 (10)	14400	20196	3,51
¾"	10	05 22 425 VA	B	2,3	100 (10)	12000	20197	3,83
1"	10	05 22 432 VA	B	3,2	80	9600	20198	4,35
1¼"	10	05 22 440 VA	B	2,9	50	6000	20199	5,30
1½"	10	05 22 450 VA	C	4,9	60	3600	20200	6,11
2"	10	05 22 463 VA	C	5,0	30	1800	20201	10,29
2½"	10	05 22 475 VA	D	7,4	24 (4)	720	20202	18,15
3"	10	05 22 490 VA	C	4,2	8	480	20203	24,50
4" (DN 80)	10	05 22 510 VA	D	6,2	8 (2)	240	20204	32,34
4"	10	05 22 511 VA	D	6,5	8 (2)	240	33733	45,79

UP. 22. VT. VA

C03 | VAL 325

**MANICOTTO VALVOLA A SFERA**

Victaulic®

BALL VALVE END CONNECTOR

Victaulic®

SIZE	PN	REF.	PACK	kg	Q(B)	Q(P)	CODE	EUR
2"	10	05 22 063 VIC	C	6,5	36	2160	27978	5,88
3"	10	05 22 090 VIC	C	5,0	12	720	27979	17,59

PE. 21. BW11. VA

C03 | APE 063

**MANICOTTO VALVOLA A SFERA**

PE 100

BALL VALVE END CONNECTOR

PE100

SIZE	PN	REF.	PACK	kg	Q(B)	Q(P)	CODE	EUR
20	16	45 21 020	B	1,3	120	14400	29399	10,36
25	16	45 21 025	B	1,3	80	9600	29400	11,34
32	16	45 21 032	B	1,3	50	6000	29401	11,98
40	16	45 21 040	B	1,2	30	3600	29402	13,05
50	16	45 21 050	B	1,5	20	2400	29403	17,62
63	16	45 21 063	B	1,5	10	1200	29404	20,61
75	16	45 21 075	D	6,8	30	900	29405	30,38
90	16	45 21 090	D	5,8	18	540	29406	37,33
90	10	45 21 090	D	5,8	18	540	29406	37,33
110	16	45 21 110	D	5,5	8	240	29407	78,09
110	10	45 21 110	D	5,5	8	240	29407	78,09

Conneessioni compatibili con le valvole a sfera Cepex Serie Standard (pag. 50 e 51) e Serie Industrial (pag. 52). Non compatibili con il nuovo modello della valvola [STD] o [IND].

End connectors compatible with the Cepex Standard Series (pag. 50 and 51) & Industrial Series (pag. 52) ball valves. Not compatible with the new valve model [STD] or [IND].

**CONNESSIONI VALVOLE A SFERA PVC-U SERIE STANDARD E INDUSTRIAL -
PVC-U BALL VALVE END CONNECTORS STANDARD & INDUSTRIAL SERIES**

UP. 24. SPI. VA

C03 | VAL 325

MANICOTTO VALV. A SFERA (PN 10)

connessione portagomma PVC-U

BALL VALVE END CON. (PN 10)

PVC-U spigot connection

SIZE	PN	REF.	PACK	kg	Q(B)	Q(P)	CODE	EUR
16 x 20	10	05 24 416	B	2,8	200 (20)	24000	02209	1,80
18 x 20	10	05 24 418	B	2,5	160 (20)	19200	02210	2,06
20 x 20	10	05 24 420	B	2,5	160 (20)	19200	02211	2,32
25 x 25	10	05 24 425	B	2,1	100 (10)	12000	02212	2,86
30 x 32	10	05 24 432	B	2,4	70	8400	02213	3,01
40 x 40	10	05 24 440	B	2,2	40	4800	02214	3,15
50 x 50	10	05 24 450	B	2,1	25	3000	02215	3,89
38 x 50	10	05 24 451	B	2,3	30	3600	05347	3,89
60 x 63	10	05 24 463	B	1,7	15	1800	02216	5,54

UP. 23. PE. VA

C03 | VAL 325

MANICOTTO VALV. A SFERA (PN 10)

connessione PE

BALL VALVE END CON. (PN 10)

PP - PE connection

SIZE	PN	REF.	PACK	kg	Q(B)	Q(P)	CODE	EUR
16	10	05 23 416	C	7,2	120	7200	23128	9,01
20	10	05 23 420	B	3,0	50	6000	23129	9,01
25	10	05 23 425	C	6,3	56	3360	23130	11,80
32	10	05 23 432	C	6,5	40	2400	23131	14,04
40	10	05 23 440	D	11,4	40	1200	23132	16,53
50	10	05 23 450	D	13,3	36	1080	23133	24,16
63	10	05 23 463	D	12,5	20	600	23134	36,92
75	10	05 23 475	D	11,8	10	300	23135	68,90
90	10	05 23 490	D	6,6	4	120	34646	90,71
110	10	05 23 510	D	9,2	4	120	34647	116,59

Conneessioni compatibili con le valvole a sfera Cepex Serie Standard (pag. 50 e 51) e Serie Industrial (pag. 52). Non compatibili con il nuovo modello della valvola [STD] o [IND].

End connectors compatible with the Cepex Standard Series (pag. 50 and 51) & Industrial Series (pag. 52) ball valves. Not compatible with the new valve model [STD] or [IND].

VALVOLE A SFERA IN PVC-U SERIE E-QUA - PVC-U BALL VALVES E-QUA SERIES

UP. 62EQ. SF5

C03 | VAL 331



PE - EPDM
incollaggio

PE - EPDM
solvent socket



SIZE	PN	REF.	PACK	kg	Q(B)	Q(P)	CODE	EUR
50	12	60 62 050	C	6,8	10	600	41544	34,14
63	12	60 62 063	D	11,9	10	300	41545	51,74

UP. 62EQ. FT5

C03 | VAL 331



PE - EPDM
filetto femmina

PE - EPDM
BSP female thread



SIZE	PN	REF.	PACK	kg	Q(B)	Q(P)	CODE	EUR
1½"	12	60 62 650	C	7,0	10	600	41546	36,23
2"	12	60 62 663	D	12,2	10	300	41547	54,59

VALVOLE A SFERA IN PVC-U SERIE PN 10 - PVC-U BALL VALVES PN 10 SERIES

UP. 62. SF5

C03 | VAL 330



PE - EPDM
incollaggio

PE - EPDM
solvent socket



SIZE	PN	REF.	PACK	kg	Q(B)	Q(P)	CODE	EUR
50	10	05 62 050	C	7,3	10	600	02502	35,95
63	10	05 62 063	D	11,2	9	270	02503	54,47

UP. 62. FT5

C03 | VAL 330



PE - EPDM
filetto femmina

PE - EPDM
BSP female thread



SIZE	PN	REF.	PACK	kg	Q(B)	Q(P)	CODE	EUR
1½"	10	05 62 650	C	7,4	10	600	02504	38,14
2"	10	05 62 663	D	11,8	9	270	02505	57,48

UP. 62. SMF5

C03 | VAL 330



PE - EPDM
incollaggio maschio x femmina

PE - EPDM
male x female solvent socket



SIZE	PN	REF.	PACK	kg	Q(B)	Q(P)	CODE	EUR
50	10	05 62 250	C	5,3	7	420	02506	36,41
63	10	05 62 263	C	5,3	4	240	02507	56,05

UP. 62. SMFT5

C03 | VAL 330



PE - EPDM
filetto maschio x incollaggio

PE - EPDM
BSP male thread x female solvent socket



SIZE	PN	REF.	PACK	kg	Q(B)	Q(P)	CODE	EUR
50 x 1½"	10	05 62 450	C	5,2	7	420	02508	40,92
63 x 2"	10	05 62 463	C	5,2	4	240	02509	58,97

VALVOLE A SFERA IN PVC-U SERIE PN 10 - PVC-U BALL VALVES PN 10 SERIES
UP. 63. PESF5

C03 | VAL 310

PE - EPDM

connessione PE x incollaggio

PE - EPDM

PE connection x solvent socket

SIZE	PN	REF.	PACK	kg	Q(B)	Q(P)	CODE	EUR
16 x 16	10	05 63 016	B	3,2	18 (9)	2160	05363	22,80
20 x 20	10	05 63 020	B	3,1	18 (9)	2160	02510	22,80
25 x 25	10	05 63 025	B	2,9	10 (5)	1200	02511	27,85
32 x 32	10	05 63 032	B	3,4	8	960	02512	36,13
40 x 40	10	05 63 040	C	7,0	10	600	02513	40,14
50 x 50	10	05 63 050	C	5,3	6	360	02514	51,01
63 x 63	10	05 63 063	D	12,2	8	240	02515	77,74
75 x 75	10	05 63 075	D	11,9	4	120	02516	216,02
90 x 90	10	05 63 090	D	9,6	2	60	34648	294,13
110 x 110	10	05 63 110	D	10,9	2	60	34649	345,10

UP. 63. PEFT5

C03 | VAL 310

PE - EPDM

connessione PE x filetto femmina

PE - EPDM

PE connection x BSP female thread

SIZE	PN	REF.	PACK	kg	Q(B)	Q(P)	CODE	EUR
16 x 3/8"	10	05 63 416	B	3,2	18 (9)	2160	05364	23,19
20 x 1/2"	10	05 63 420	B	3,0	18 (9)	2160	02517	23,19
25 x 3/4"	10	05 63 425	B	2,9	10 (5)	1200	02518	28,22
32 x 1"	10	05 63 432	B	3,5	8	960	02519	36,68
40 x 1 1/4"	10	05 63 440	C	7,0	10	600	02520	41,06
50 x 1 1/2"	10	05 63 450	C	5,4	6	360	02521	52,33
63 x 2"	10	05 63 463	D	12,5	8	240	02522	78,33
75 x 2 1/2"	10	05 63 475	D	11,9	4	120	02523	220,33
90 x 3"	10	05 63 490	D	9,7	2	60	34650	294,13
110 x 4"	10	05 63 510	D	11,0	2	60	34651	361,86

UP. 63. PE5

C03 | VAL 310

PE - EPDM

connessione PE

PE - EPDM

PE connection

SIZE	PN	REF.	PACK	kg	Q(B)	Q(P)	CODE	EUR
16 x 16	10	05 63 616	B	2,8	14 (7)	1680	05365	28,32
20 x 20	10	05 63 620	B	2,6	14 (7)	1680	02524	28,32
25 x 25	10	05 63 625	B	3,3	10	1200	02525	35,98
32 x 32	10	05 63 632	B	2,5	5	600	02526	45,30
40 x 40	10	05 63 640	C	5,8	7	420	02527	50,48
50 x 50	10	05 63 650	C	5,3	5	300	02528	67,63
63 x 63	10	05 63 663	D	11,0	6	180	02529	102,82
75 x 75	10	05 63 675	D	10,7	3	90	02530	239,26
90 x 90	10	05 63 690	E	16,9	3	45	34652	329,77
110 x 110	10	05 63 710	E	13,3	2	30	34653	392,16

Accessori PVC-U

Valvole PVC-U

Accessori PVC-C

Valvole PVC-C

Valvole Extreme

Evacuazione

Ricambi

VALVOLE A SFERA IN PVC-U SERIE UNIBLOCK - PVC-U BALL VALVES UNIBLOCK SERIES

UP. 70S. SF5

C03 | VAL 340



PE - EPDM
incollaggio

PE - EPDM
solvent socket



SIZE	PN	REF.	PACK	kg	Q(B)	Q(P)	CODE	EUR
20	10	05 70 020	B	2,5	24 (12)	2880	22773	12,48
25	10	05 70 025	B	2,0	12 (6)	1440	22774	14,31
32	10	05 70 032	B	2,8	12	1440	22775	18,70
40	10	05 70 040	B	2,2	6	720	22776	22,03
50	10	05 70 050	C	5,5	12	720	11375	28,94
63	10	05 70 063	D	10,2	12	360	15826	43,17
75	10	05 70 075	D	7,3	4 (1)	120	22777	121,04
90	10	05 70 090	D	6,1	2 (1)	60	22778	178,07
110	10	05 70 111	D	6,1	1	30	36728	340,62

UP. 70S. FT5

C03 | VAL 340



PE - EPDM
filetto femmina

PE - EPDM
BSP female thread



SIZE	PN	REF.	PACK	kg	Q(B)	Q(P)	CODE	EUR
½"	10	05 70 620	B	2,5	24 (12)	2880	22791	13,41
¾"	10	05 70 625	B	1,9	12 (6)	1440	22792	15,43
1"	10	05 70 632	B	2,8	12	1440	22793	19,84
1¼"	10	05 70 640	B	2,2	6	720	22794	24,22
1½"	10	05 70 650	C	5,8	12	720	11377	31,41
2"	10	05 70 663	D	11,5	12	360	15829	46,77
2½"	10	05 70 675	D	7,3	4 (1)	120	22795	130,74
3"	10	05 70 690	D	6,2	2 (1)	60	22796	188,10
4"	10	05 70 711	D	6,1	1	30	36729	372,61

UP. 70S. MT5

C03 | VAL 340



PE - EPDM
incollaggio x filetto maschio

PE - EPDM
solvent socket x BSP male thread



SIZE	PN	REF.	PACK	kg	Q(B)	Q(P)	CODE	EUR
20 x ½"	10	05 70 420	B	2,1	20 (10)	2400	22785	13,25
25 x ¾"	10	05 70 425	B	1,9	12 (6)	1440	22786	15,16
32 x 1"	10	05 70 432	B	2,9	12	1440	22787	19,29
40 x 1¼"	10	05 70 440	B	2,3	6	720	22788	23,40
50 x 1½"	10	05 70 450	C	6,2	12	720	11374	30,11
63 x 2"	10	05 70 463	D	10,4	11	330	15827	45,11
75 x 2½"	10	05 70 475	D	7,7	4 (1)	120	22789	128,35
90 x 3"	10	05 70 490	D	6,3	2 (1)	60	22790	186,76
110 x 4"	10	05 70 511	D	6,2	1	30	36730	372,61

UP. 70F. MT5

C03 | VAL 340



PE - EPDM
filetto femmina x filetto maschio

PE - EPDM
BSP female x male thread



SIZE	PN	REF.	PACK	kg	Q(B)	Q(P)	CODE	EUR
½"	10	05 70 220	B	2,1	20 (10)	2400	22779	13,71
¾"	10	05 70 225	B	2,0	12 (6)	1440	22780	15,71
1"	10	05 70 232	B	2,9	12	1440	22781	20,12
1¼"	10	05 70 240	B	2,3	6	720	22782	24,50
1½"	10	05 70 250	C	5,9	12	720	11376	31,41
2"	10	05 70 263	D	10,8	11	330	15828	46,77
2½"	10	05 70 275	D	7,7	4 (1)	120	22783	133,18
3"	10	05 70 290	D	6,6	2 (1)	60	22784	193,64
4"	10	05 70 311	-	-	-	-	36731	385,43

UP. 70M. SF5

C03 | VAL 340



PE - EPDM
filetto maschio x incollaggio

PE - EPDM
BSP male thread x solvent socket



SIZE	PN	REF.	PACK	kg	Q(B)	Q(P)	CODE	EUR
½" x 20	10	05 70 320	B	2,4	20 (10)	2400	23098	12,48
¾" x 25	10	05 70 325	B	2,3	12 (6)	1440	23099	14,31
1" x 32	10	05 70 332	B	3,4	12	1440	23100	18,17
1¼" x 40	10	05 70 340	B	2,3	6	720	23101	22,03

VALVOLE A SFERA IN PVC-U SERIE UNIBLOCK - PVC-U BALL VALVES UNIBLOCK SERIES
UP. 70PE. SF5

C03 | VAL 340



PE - EPDM
connessione PE x incollaggio

PE - EPDM
PE connection x solvent socket

SIZE	PN	REF.	PACK	kg	Q(B)	Q(P)	CODE	EUR
20	10	05 70 120	B	2,8	20 (10)	2400	23090	15,60
25	10	05 70 125	B	2,4	10 (5)	1200	23091	18,17
32	10	05 70 132	B	2,7	8	960	23092	23,10
40	10	05 70 140	C	4,9	8	480	23093	29,37

UP. 70PE. FT5

C03 | VAL 340



PE - EPDM
connessione PE x filetto femmina

PE - EPDM
PE connection x BSP female thread

SIZE	PN	REF.	PACK	kg	Q(B)	Q(P)	CODE	EUR
20 x 1/2"	10	05 70 520	B	2,5	16 (8)	1920	23094	16,09
25 x 3/4"	10	05 70 525	B	2,5	10 (5)	1200	23095	18,75
32 x 1"	10	05 70 532	B	2,7	8	960	23096	23,98
40 x 1 1/4"	10	05 70 540	B	2,4	4	480	23097	30,47

VALVOLE A SFERA IN PVC-U SERIE 3 VIE - PVC-U BALL VALVES 3-WAY SERIES
UP. 74. SF1

C03 | VAL 350



PE - EPDM
incollaggio

PE - EPDM
solvent socket

SIZE	PN	REF.	PACK	kg	Q(B)	Q(P)	CODE	EUR
50	10	05 74 050	B	2,0	1	120	20168	104,08

UP. 74. FT1

C03 | VAL 350



PE - EPDM
filetto femmina

PE - EPDM
BSP female thread

SIZE	PN	REF.	PACK	kg	Q(B)	Q(P)	CODE	EUR
1 1/2"	10	05 74 650	B	2,0	1	120	20170	108,53

UP. 74. OSF1

C03 | VAL 350



PE - EPDM
incollaggio (manicotti orientabili)

PE - EPDM
solvent socket (self-align unions)

SIZE	PN	REF.	PACK	kg	Q(B)	Q(P)	CODE	EUR
50	10	05 74 250	B	2,0	1	120	20169	128,69

Accessori PVC-U

Valvole PVC-U

Accessori PVC-C

Valvole PVC-C

Valvole Extreme

Evacuazione

Ricambi

VALVOLE DI RITEGNO IN PVC-U SERIE MOLLA - PVC-U CHECK VALVES SPRING SERIES

UP-S. 67. SF1

C03 | APC 410



O-Ring in EPDM
incollaggio

EPDM O-Rings
solvent socket

SIZE	PN	REF.	PACK	kg	Q(B)	Q(P)	CODE	EUR
16	16	05 67 016	B	3,3	24 (12)	2880	09010	19,54
20	16	05 67 020	B	3,2	24 (12)	2880	09011	19,54
25	16	05 67 025	B	2,6	12 (6)	1440	09012	23,52
32	16	05 67 032	B	3,2	10	1200	09013	25,58
40	16	05 67 040	B	3,0	6	720	09014	29,84
50	16	05 67 050	C	7,5	12	720	09015	42,76
63	16	05 67 063	D	11,1	10	300	09016	61,71
75	10	05 67 075	D	8,5	4 (1)	120	09017	135,75
90	10	05 67 090	D	7,1	2 (1)	60	09018	174,66
110 (DN 80)	10	05 67 110	D	7,6	2 (1)	60	09019	189,80
110	10	05 67 111	D	7,3	1	30	37076	366,21

UP-S. 67. FT1

C03 | APC 410



O-Ring in EPDM
filetto femmina

EPDM O-Rings
BSP female thread

SIZE	PN	REF.	PACK	kg	Q(B)	Q(P)	CODE	EUR
3/8"	16	05 67 616	B	3,2	24 (12)	2880	09020	20,45
1/2"	16	05 67 620	B	3,2	24 (12)	2880	09021	20,45
3/4"	16	05 67 625	B	2,6	12 (6)	1440	09022	24,36
1"	16	05 67 632	B	3,2	10	1200	09023	26,71
1 1/4"	16	05 67 640	B	3,0	6	720	09024	31,32
1 1/2"	16	05 67 650	C	7,7	12	720	09025	44,15
2"	16	05 67 663	D	11,6	10	300	09026	64,50
2 1/2"	10	05 67 675	D	8,6	4 (1)	120	09027	147,05
3"	10	05 67 690	D	7,3	2 (1)	60	09028	188,89
4" (DN 80)	10	05 67 710	D	7,4	2 (1)	60	09029	206,70
4"	10	05 67 711	D	7,2	1	30	37077	408,94

UP-S. 67. SF4

C03 | APC 410



O-Ring in FPM
incollaggio

FPM O-Rings
solvent socket

SIZE	PN	REF.	PACK	kg	Q(B)	Q(P)	CODE	EUR
16	16	05 67 016 VI	B	3,3	24 (12)	2880	18751	37,78
20	16	05 67 020 VI	B	3,3	24 (12)	2880	18752	37,78
25	16	05 67 025 VI	B	2,7	12 (6)	1440	18753	41,11
32	16	05 67 032 VI	B	3,2	10	1200	18754	46,01
40	16	05 67 040 VI	B	3,0	6	720	18755	56,89
50	16	05 67 050 VI	C	7,6	12	720	18756	81,90
63	16	05 67 063 VI	D	11,4	10	300	18757	104,24
75	10	05 67 075 VI	D	8,5	4 (1)	120	18758	186,15
90	10	05 67 090 VI	D	7,2	2 (1)	60	18759	232,91
110 (DN 80)	10	05 67 110 VI	D	7,5	2 (1)	60	18760	254,61
110	10	05 67 111 VI	D	7,3	1	30	62039	486,28

UP-S. 67. FT4

C03 | APC 410



O-Ring in FPM
filetto femmina

FPM O-Rings
BSP female thread

SIZE	PN	REF.	PACK	kg	Q(B)	Q(P)	CODE	EUR
3/8"	16	05 67 616 VI	B	3,2	24 (12)	2880	18761	38,80
1/2"	16	05 67 620 VI	B	3,2	24 (12)	2880	18762	38,80
3/4"	16	05 67 625 VI	B	2,7	12 (6)	1440	18763	42,26
1"	16	05 67 632 VI	B	3,2	10	1200	18764	47,80
1 1/4"	16	05 67 640 VI	B	3,1	6	720	18765	59,21
1 1/2"	16	05 67 650 VI	C	7,9	12	720	18766	84,91
2"	16	05 67 663 VI	D	11,6	10	300	18767	108,17
2 1/2"	10	05 67 675 VI	D	8,5	4 (1)	120	18768	196,56
3"	10	05 67 690 VI	D	6,8	2 (1)	60	18769	243,93
4" (DN 80)	10	05 67 710 VI	D	7,4	2 (1)	60	18770	267,02
4"	10	05 67 711 VI	D	7,2	1	30	62040	536,08

VALVOLE DI FONDO IN PVC-U SERIE MOLLA - PVC-U FOOT VALVES SPRING SERIES

UP-S. 66. SF1

C03 | APC 410

O-Ring in EPDM
incollaggio

EPDM O-Rings
solvent socket

SIZE	PN	REF.	PACK	kg	Q(B)	Q(P)	CODE	EUR
16	16	05 66 016	B	3,0	24 (12)	2880	08990	20,58
20	16	05 66 020	B	3,0	24 (12)	2880	08991	20,58
25	16	05 66 025	B	2,4	12 (6)	1440	08992	24,68
32	16	05 66 032	B	2,9	10	1200	08993	26,87
40	16	05 66 040	B	2,8	6	720	08994	31,46
50	16	05 66 050	C	3,5	6	360	08995	44,66
63	16	05 66 063	C	4,0	4	240	08996	65,05
75	10	05 66 075	D	7,9	4 (2)	120	08997	142,79
90	10	05 66 090	D	6,5	2 (1)	60	08998	183,86
110 (DN 80)	10	05 66 110	D	6,7	2 (1)	60	08999	192,17

UP-S. 66. FT1

C03 | APC 410

O-Ring in EPDM
filetto femmina

EPDM O-Rings
BSP female thread

SIZE	PN	REF.	PACK	kg	Q(B)	Q(P)	CODE	EUR
3/8"	16	05 66 616	B	3,1	24 (12)	2880	09000	20,58
1/2"	16	05 66 620	B	3,0	24 (12)	2880	09001	20,58
3/4"	16	05 66 625	B	2,5	12 (6)	1440	09002	24,68
1"	16	05 66 632	B	3,0	10	1200	09003	27,54
1 1/4"	16	05 66 640	B	2,8	6	720	09004	32,08
1 1/2"	16	05 66 650	C	3,5	6	360	09005	45,52
2"	16	05 66 663	C	4,1	4	240	09006	66,50
2 1/2"	10	05 66 675	D	7,6	4 (2)	120	09007	148,54
3"	10	05 66 690	D	6,6	2 (1)	60	09008	190,39
4" (DN 80)	10	05 66 710	D	6,5	2 (1)	60	09009	198,72

UP-S. 66. SF4

C03 | APC 410

O-Ring in FPM
incollaggio

FPM O-Rings
solvent socket

SIZE	PN	REF.	PACK	kg	Q(B)	Q(P)	CODE	EUR
16	16	05 66 016 VI	B	3,1	24 (12)	2880	18731	38,73
20	16	05 66 020 VI	B	3,0	24 (12)	2880	18732	38,73
25	16	05 66 025 VI	B	2,5	12 (6)	1440	18733	43,06
32	16	05 66 032 VI	B	3,0	10	1200	18734	48,01
40	16	05 66 040 VI	B	2,8	6	720	18735	56,90
50	16	05 66 050 VI	C	3,4	6	360	18736	84,11
63	16	05 66 063 VI	C	4,1	4	240	18737	106,62
75	10	05 66 075 VI	D	8,0	4 (2)	120	18738	195,01
90	10	05 66 090 VI	D	6,6	2 (1)	60	18739	243,53
110 (DN 80)	10	05 66 110 VI	D	6,8	2 (1)	60	18740	255,92

UP-S. 66. FT4

C03 | APC 410

O-Ring in FPM
filetto femmina

FPM O-Rings
BSP female thread

SIZE	PN	REF.	PACK	kg	Q(B)	Q(P)	CODE	EUR
3/8"	16	05 66 616 VI	B	3,4	24 (12)	2880	18741	39,24
1/2"	16	05 66 620 VI	B	3,0	24 (12)	2880	18742	39,24
3/4"	16	05 66 625 VI	B	2,5	12 (6)	1440	18743	43,67
1"	16	05 66 632 VI	B	3,0	10	1200	18744	48,87
1 1/4"	16	05 66 640 VI	B	2,8	6	720	18745	58,09
1 1/2"	16	05 66 650 VI	C	3,6	6	360	18746	86,36
2"	16	05 66 663 VI	C	3,8	4	240	18747	108,56
2 1/2"	10	05 66 675 VI	D	8,0	4 (2)	120	18748	200,23
3"	10	05 66 690 VI	D	6,9	2 (1)	60	18749	249,08
4" (DN 80)	10	05 66 710 VI	D	6,8	2 (1)	60	18750	261,90

Accessori PVC-U

Valvole PVC-U

Accessori PVC-C

Valvole PVC-C

Valvole Extreme

Evacuazione

Ricambi

VALVOLE DI RITEGNO IN PVC-U SERIE SFERA - PVC-U CHECK VALVES BALL SERIES

UP-B. 67. SF1

C03 | APC 430



O-Ring in EPDM
incollaggio

EPDM O-Rings
solvent socket

SIZE	PN	REF.	PACK	kg	Q(B)	Q(P)	CODE	EUR
20	16	05 67 220	B	3,3	24 (12)	2880	22078	21,90
25	16	05 67 225	B	2,8	12 (6)	1440	22079	25,54
32	16	05 67 232	B	3,4	10	1200	22080	40,96
40	16	05 67 240	B	3,3	6	720	22174	46,40
50	16	05 67 250	C	8,0	12	720	25697	63,28
63	16	05 67 263	D	12,1	10	300	25698	90,28
75	10	05 67 275	D	9,7	4 (1)	120	22175	183,47
90	10	05 67 290	D	8,4	2 (1)	60	22176	263,07
110 (DN 80)	10	05 67 310	D	8,8	2 (1)	60	22177	277,42

UP-B. 67. FT1

C03 | APC 430



O-Ring in EPDM
filetto femmina

EPDM O-Rings
BSP female thread

SIZE	PN	REF.	PACK	kg	Q(B)	Q(P)	CODE	EUR
½"	16	05 67 420	B	3,4	24 (12)	2880	22061	22,83
¾"	16	05 67 425	B	2,9	12 (6)	1440	22062	26,66
1"	16	05 67 432	B	3,5	10	1200	22085	42,76
1¼"	16	05 67 440	B	3,3	6	720	22086	48,96
1½"	16	05 67 450	C	8,4	12	720	25699	66,68
2"	16	05 67 463	D	12,6	10	300	25700	93,79
2½"	10	05 67 475	D	9,8	4 (1)	120	22087	189,95
3"	10	05 67 490	D	8,4	2 (1)	60	22088	272,26
4" (DN 80)	10	05 67 510	D	8,6	2 (1)	60	22089	283,82

UP-B. 67. SF4

C03 | APC 430



O-Ring in FPM
incollaggio

FPM O-Rings
solvent socket

SIZE	PN	REF.	PACK	kg	Q(B)	Q(P)	CODE	EUR
20	16	05 67 220 VI	B	3,4	24 (12)	2880	22090	40,49
25	16	05 67 225 VI	B	2,9	12 (6)	1440	22091	43,01
32	16	05 67 232 VI	B	3,5	10	1200	22092	63,63
40	16	05 67 240 VI	B	3,3	6	720	22239	75,31
50	16	05 67 250 VI	C	8,3	12	720	25701	94,65
63	16	05 67 263 VI	D	11,6	10	300	25702	123,71
75	10	05 67 275 VI	D	10,6	4 (1)	120	22240	240,75
90	10	05 67 290 VI	D	8,5	2 (1)	60	22241	328,51
110 (DN 80)	10	05 67 310 VI	D	8,9	2 (1)	60	22242	348,02

UP-B. 67. FT4

C03 | APC 430



O-Ring in FPM
filetto femmina

FPM O-Rings
BSP female thread

SIZE	PN	REF.	PACK	kg	Q(B)	Q(P)	CODE	EUR
½"	16	05 67 420 VI	B	3,5	24 (12)	2880	22243	41,32
¾"	16	05 67 425 VI	B	2,9	12 (6)	1440	22244	44,14
1"	16	05 67 432 VI	B	3,5	10	1200	22267	65,40
1¼"	16	05 67 440 VI	B	3,3	6	720	22268	77,66
1½"	16	05 67 450 VI	C	8,5	12	720	25703	98,03
2"	16	05 67 463 VI	D	12,6	10	300	25704	127,36
2½"	10	05 67 475 VI	D	10,3	4 (1)	120	22269	247,95
3"	10	05 67 490 VI	D	8,4	2 (1)	60	22270	338,51
4" (DN 80)	10	05 67 510 VI	D	7,3	2 (1)	60	22893	294,26

VALVOLE DI FONDO IN PVC-U SERIE SFERA - PVC-U FOOT VALVES BALL SERIES

UP-B. 66. SF1

C03 | APC 430

O-Ring in EPDM
 incollaggio

EPDM O-Rings
 solvent socket

SIZE	PN	REF.	PACK	kg	Q(B)	Q(P)	CODE	EUR
20	16	05 66 220	B	3,1	24 (12)	2880	27537	23,06
25	16	05 66 225	B	2,6	12 (6)	1440	27538	26,99
32	16	05 66 232	B	3,2	10	1200	27539	44,96
40	16	05 66 240	B	3,0	6	720	27540	48,86
50	16	05 66 250	C	3,7	6	360	25705	58,66
63	16	05 66 263	C	4,4	4	240	25706	87,80
75	10	05 66 275	D	9,0	4 (2)	120	27543	197,31
90	10	05 66 290	D	7,8	2 (1)	60	27544	278,12
110 (DN 80)	10	05 66 310	D	8,0	2 (1)	60	27545	286,61

UP-B. 66. FT1

C03 | APC 430

O-Ring in EPDM
 filetto femmina

EPDM O-Rings
 BSP female thread

SIZE	PN	REF.	PACK	kg	Q(B)	Q(P)	CODE	EUR
½"	16	05 66 420	B	3,2	24 (12)	2880	27546	23,49
¾"	16	05 66 425	B	2,6	12 (6)	1440	27547	27,54
1"	16	05 66 432	B	3,1	10	1200	27548	45,77
1¼"	16	05 66 440	B	3,0	6	720	27549	50,20
1½"	16	05 66 450	C	3,8	6	360	25707	60,30
2"	16	05 66 463	C	4,5	4	240	25708	89,62
2½"	10	05 66 475	D	9,2	4 (2)	120	27552	201,55
3"	10	05 66 490	D	7,9	2 (1)	60	27553	282,48
4" (DN 80)	10	05 66 510	D	8,0	2 (1)	60	27554	288,79

UP-B. 66. SF4

C03 | APC 430

O-Ring in FPM
 incollaggio

FPM O-Rings
 solvent socket

SIZE	PN	REF.	PACK	kg	Q(B)	Q(P)	CODE	EUR
20	16	05 66 220 VI	B	3,2	24 (12)	2880	27555	45,18
25	16	05 66 225 VI	C	5,0	24 (6)	1440	27556	45,28
32	16	05 66 232 VI	B	3,2	10	1200	27557	68,80
40	16	05 66 240 VI	B	3,1	6	720	27558	79,36
50	16	05 66 250 VI	C	3,8	6	360	25709	90,57
63	16	05 66 263 VI	C	4,5	4	240	25710	121,28
75	10	05 66 275 VI	D	9,1	4 (2)	120	27561	259,45
90	10	05 66 290 VI	D	8,1	2 (1)	60	27562	351,11
110 (DN 80)	10	05 66 310 VI	D	7,9	2 (1)	60	27563	364,15

UP-B. 66. FT4

C03 | APC 430

O-Ring in FPM
 filetto femmina

FPM O-Rings
 BSP female thread

SIZE	PN	REF.	PACK	kg	Q(B)	Q(P)	CODE	EUR
½"	16	05 66 420 VI	B	3,2	24 (12)	2880	27564	45,55
¾"	16	05 66 425 VI	B	2,9	12 (6)	1440	27565	45,77
1"	16	05 66 432 VI	B	3,2	10	1200	27566	69,49
1¼"	16	05 66 440 VI	B	3,1	6	720	27567	80,47
1½"	16	05 66 450 VI	C	4,0	6	360	25711	92,76
2"	16	05 66 463 VI	C	4,6	4	240	25712	125,03
2½"	10	05 66 475 VI	D	9,2	4 (2)	120	27570	263,77
3"	10	05 66 490 VI	D	8,1	2 (1)	60	27571	355,51
4" (DN 80)	10	05 66 510 VI	D	6,5	2 (1)	60	27572	383,74

Accessori PVC-U

Valvole PVC-U

Accessori PVC-C

Valvole PVC-C

Valvole Extreme

Evacuazione

Ricambi

VALVOLE DI RITEGNO IN PVC-U SERIE UNIBLOCK - PVC-U CHECK VALVES UNIBLOCK SERIES

UP-S. 93. SF1

C03 | APC 410



O-Ring in EPDM
incollaggio

EPDM O-Rings
solvent socket

SIZE	PN	REF.	PACK	kg	Q(B)	Q(P)	CODE	EUR
20	10	05 93 020	B	3,1	32 (16)	3840	36559	15,73
25	10	05 93 025	B	2,4	16 (8)	1920	36560	19,39
32	10	05 93 032	B	2,7	12	1440	36561	21,70
40	10	05 93 040	B	3,0	8	960	36562	25,72
50	10	05 93 050	C	4,6	12	720	36563	37,76
63	10	05 93 063	D	9,4	12	360	36564	53,80
75	10	05 93 075	D	5,9	4 (1)	120	36565	125,49
90	10	05 93 090	D	5,6	2 (1)	60	36566	159,50
110 (DN80)	10	05 93 111	D	5,1	1	30	36567	336,69

UP-S. 93. FT1

C03 | APC 410



O-Ring in EPDM
filetto femmina

EPDM O-Rings
BSP female thread

SIZE	PN	REF.	PACK	kg	Q(B)	Q(P)	CODE	EUR
½"	10	05 93 620	B	2,4	24 (12)	2880	36568	16,49
¾"	10	05 93 625	B	2,4	16 (8)	1920	36569	19,41
1"	10	05 93 632	B	2,7	12	1440	36570	21,57
1¼"	10	05 93 640	B	2,3	6	720	36571	25,04
1½"	10	05 93 650	C	5,0	12	720	36572	37,20
2"	10	05 93 663	D	10,0	12	360	36573	60,41
2½"	10	05 93 675	D	5,9	4 (1)	120	36574	119,65
3"	10	05 93 690	D	5,0	2 (1)	60	36575	155,43
4" (DN80)	10	05 93 711	D	5,1	1	30	36576	360,11

VALVOLE A CLAPET IN PVC-U - PVC-U SWING CHECK VALVES

UP. 65

C03 | APC 450



O-Ring in EPDM

EPDM O-Rings

SIZE	PN	REF.	PACK	kg	Q(B)	Q(P)	CODE	EUR
63	6	05 65 063 *	B	3,9	15 (1)	1800	37055	64,11
75	6	05 65 075	B	3,0	10 (1)	1200	08984	66,02
90	6	05 65 090	B	3,0	8 (1)	960	08985	80,61
110	6	05 65 110	B	2,7	5 (1)	600	08986	99,00
125	6	05 65 125	B	3,2	5 (1)	600	09040	108,26
140	6	05 65 140	C	7,8	10 (1)	600	08987	121,82
160	6	05 65 160	C	5,5	5 (1)	300	08988	129,44
200	6	05 65 200	C	5,6	4 (1)	240	09041	145,93
225	6	05 65 225	C	6,0	3 (1)	180	08989	164,99
250	6	05 65 250	D	12,9	4 (1)	120	37056	282,16
280	6	05 65 280 *	D	13,6	4 (1)	120	41865	291,47
315	6	05 65 315 *	D	4,9	1 (1)	30	37057	439,74

UP. 65. VKIT

C03 | APC 450



VALVOLA A CLAPET COMPLETA









Contiene:
Valvola + 2 flange + 2 collari + bulloneria

COMPLETE CLAPET VALVE

Contains:
Valve + 2 flange adaptor + 2 backing ring
+ bolts

SIZE	PN	REF.	PACK	kg	Q(B)	Q(P)	CODE	EUR
63	6	05 65 063 RA *	B	4,3	2	240	37073	123,26
75	6	05 65 075 RA	B	5,1	2	240	23312	136,13
90	6	05 65 090 RA	C	12,2	3	180	23313	180,29
110	6	05 65 110 RA	C	10,2	2	120	23314	223,06
125	6	05 65 125 RA	C	11,0	2	120	23315	275,40
140	6	05 65 140 RA	D	12,6	2	60	23316	312,28
160	6	05 65 160 RA	D	10,1	1	30	23317	417,73
200	6	05 65 200 RA	D	11,7	1	30	23318	555,99
225	6	05 65 225 RA	E	12,9	1	15	23319	630,10
250	6	05 65 250 RA	E	22,1	1	15	37074	1.352,58
315	6	05 65 315 RA *	F	26,4	1	10	37075	1.954,66

VALVOLE A FARFALLA IN PVC-U SERIE STANDARD - PVC-U BUTTERFLY VALVES STANDARD SERIES

Serie Standard	Corpo Body	Lente Disc	Guarnizione Rubber seal	Perno Shaft	Diametri Sizes	PN PN	
Maniglia in PP con sistema di sicurezza PP-GF handle with locking device	PVC-U	PVC-U	EPDM	Acciaio zincato Zinc plated steel	D63 - D225 (2" - 8")	10 bar 150 p.s.i.	
			FPM		D250-D315 (10"-12")	6 bar 90 p.s.i.	
63 - 75	90	110	125 - 140	160	200 - 225	250 315	
							

UP. 83. ZP. EP

C03 | VMA 510



O-Ring in EPDM
perno in acciaio zincato

EPDM O-Rings
zinc plated steel shaft

SIZE	PN	REF.	PACK	kg	Q(B)	Q(P)	CODE	EUR
63-75	10	05 83 075	V	2,8	2	168	32614	197,52
90	10	05 83 090	V	3,3	2	168	32615	223,68
110	10	05 83 110	VI	4,6	2	126	32616	246,20
125-140	10	05 83 140	VII	6,3	2	112	32617	285,57
160	10	05 83 160	VIII	8,1	2	72	32618	347,07
200-225	10	05 83 200	IX	13,5	2	48	32619	491,07
250	6	05 83 250	IV	16,6	1	20	46647	1.249,87
315	6	05 83 315	IV	22,1	1	20	46648	2.148,42

UP. 83. ZP. VI

C03 | VMA 510



O-Ring in FPM
perno in acciaio zincato

FPM O-Rings
zinc plated steel shaft

SIZE	PN	REF.	PACK	kg	Q(B)	Q(P)	CODE	EUR
63-75	10	05 83 075 VI	V	2,8	2	168	34532	336,44
90	10	05 83 090 VI	V	3,4	2	168	34533	397,74
110	10	05 83 110 VI	VI	4,6	2	126	34534	547,54
125-140	10	05 83 140 VI	VII	6,3	2	112	34535	669,43
160	10	05 83 160 VI	VIII	8,1	2	72	34536	944,68
200-225	10	05 83 200 VI	IV	14,0	2	48	34537	1.373,03

Accessori PVC-U

Valvole PVC-U

Accessori PVC-C

Valvole PVC-C

Valvole Extreme

Evacuazione

Ricambi

VALVOLE A FARFALLA IN PVC-U SERIE CLASSIC - PVC-U BUTTERFLY VALVES CLASSIC SERIES

Serie Classic	Corpo Body	Lente Disc	Guarnizione Rubber seal	Perno Shaft	Diametri Sizes	PN PN
Maniglia in alluminio Aluminium handle	PVC-U	PVC-U	EPDM	Acciaio zincato Zinc plated steel	D63 - D140 (2" - 5")	10 bar 150 p.s.i.
			FPM	Acciaio inox. Stainless steel shaft	D160 - D250 (6" - 10")	6 bar 90 p.s.i.
63 - 75	90	110	125 - 140	160	200 - 225	250
						

UP. 80. Z3

C03 | VMA 510



O-Ring in EPDM
perno in acciaio zincato

EPDM O-Rings
zinc plated steel shaft

SIZE	PN	REF.	PACK	kg	Q(B)	Q(P)	CODE	EUR
63-75	10	05 80 075	I	3,8	2	140	02581	228,01
90	10	05 80 090	I	5,2	2	140	02582	258,28
110	10	05 80 110	II	7,4	2	98	02583	284,31
125-140	10	05 80 140	III	9,9	2	70	02585	332,58
160	6	05 80 160	III	11,9	2	70	02586	404,24
200-225	6	05 80 200	IV	18,6	2	40	02587	571,95
250	6	05 80 250	IV	11,2	1	20	15846	1.290,04

UP. 80. I4

C03 | VMA 510



O-Ring in FPM
perno in acciaio inox

FPM O-Rings
stainless steel shaft

SIZE	PN	REF.	PACK	kg	Q(B)	Q(P)	CODE	EUR
63-75	10	05 80 075 IV	I	3,8	2	140	16713	388,49
90	10	05 80 090 IV	I	5,2	2	140	16714	500,42
110	10	05 80 110 IV	II	7,4	2	98	16715	642,44
125-140	10	05 80 140 IV	III	9,9	2	70	16716	851,74
160	6	05 80 160 IV	III	11,5	2	70	16717	1.150,33
200-225	6	05 80 200 IV	IV	18,6	2	40	16718	1.599,17
250	6	05 80 250 IV	IV	11,2	1	20	22426	1.765,18

UP. 81. RA

C03 | ACP 120

**KIT ACCOPPIAMENTO VALVOLA**

Contiene:
2 flange + 2 collari + bulloneria

VALVE ASSEMBLY KIT

Contains:
2 flange adaptor + 2 backing ring + bolts

SIZE	PN	REF.	PACK	kg	Q(B)	Q(P)	CODE	EUR
63	16	05 81 063 RA	B	5,6	3	360	09119	60,69
75	16	05 81 075 RA	B	4,7	2	240	09120	79,04
90	16	05 81 090 RA	C	12,0	3	180	09121	121,26
110	16	05 81 110 RA	C	9,4	2	120	09122	145,38
125	16	05 81 125 RA	C	10,3	2	120	09123	185,53
140	16	05 81 140 RA	D	11,4	2	60	09124	209,72
160	10	05 81 160 RA	D	18,8	2	60	09125	325,54
200	10	05 81 200 RA	D	10,8	1	30	09126	419,49
225	10	05 81 225 RA	E	11,8	1	15	09127	474,96
250	10	05 81 250 RA	E	20,3	1	15	16060	990,59

VALVOLE A FARFALLA (LENTE IN PVC-U) SERIE INDUSTRIAL - PVC-U BUTTERFLY VALVES INDUSTRIAL SERIES

Serie Industrial	Corpo Body	Lente Disc	Guarnizione Rubber seal	Perno Shaft	Diametri Sizes	PN PN	
Maniglia in PP con sistema di sicurezza PP-GF handle with locking device	PP - GF	PVC-U	EPDM perox. FPM	Acciaio INOX Stainless steel	D63 - D225 (2" - 8")	10 bar 150 p.s.i.	
63 - 75	90	110	125 - 140	160	200 - 225		
Riduttore manuale Gear box	PP - GF	PVC-U	EPDM perox. FPM	Acciaio INOX Stainless steel	D63 - D225 (2" - 8") D250-D315 (10"-12")	10 bar 150 p.s.i. 6 bar 90 p.s.i.	
63 - 75	90	110	125 - 140	160	200 - 225	250 - 280	315

UP. 84. SS. FGEP

C03 | VMA 515

O-Ring in EPDM perox.
perno in acciaio inox

EPDM perox. O-rings
stainless steel shaft

SIZE	PN	REF.	PACK	kg	Q(B)	Q(P)	CODE	EUR
63-75	10	05 84 075	V	2,5	2	168	32620	285,89
90	10	05 84 090	VII	3,2	2	112	32621	328,81
110	10	05 84 110	VII	4,4	2	112	32622	377,30
125-140	10	05 84 140	VIII	6,3	2	48	32623	497,77
160	10	05 84 160	IX	7,9	2	48	32624	617,63
200-225	10	05 84 200	VII	6,8	1	36	32625	952,65

UP. 84. SS. VI

C03 | VMA 515

O-Ring in FPM
perno in acciaio inox

FPM O-Rings
stainless steel shaft

SIZE	PN	REF.	PACK	kg	Q(B)	Q(P)	CODE	EUR
63-75	10	05 84 075 VI	V	2,5	2	168	32628	376,75
90	10	05 84 090 VI	VII	3,3	2	112	32629	463,15
110	10	05 84 110 VI	VII	4,4	2	112	32630	601,92
125-140	10	05 84 140 VI	VIII	6,3	2	48	32631	794,04
160	10	05 84 160 VI	IX	8,2	2	48	32632	984,62
200-225	10	05 84 200 VI	VII	7,0	1	36	32633	1.567,02

UP. 84. SS. FGEP. RM

C03 | VMA 550

O-Ring in EPDM perox.
perno in acciaio inox

EPDM perox. O-rings
stainless steel shaft

SIZE	PN	REF.	PACK	kg	Q(B)	Q(P)	CODE	EUR
63-75	10	05 84 075 RM	C	2,7	1	60	34466	796,31
90	10	05 84 090 RM	C	3,1	1	60	34467	813,83
110	10	05 84 110 RM	C	3,3	1	60	34468	893,25
125-140	10	05 84 140 RM	D	4,3	1	30	34469	1.010,40
160	10	05 84 160 RM	E	5,2	1	36	34470	1.398,35
200-225	10	05 84 200 RM	E	8,4	1	15	34471	1.971,96
250-280	6	05 84 250 RM	F	18,2	1	10	34472	3.273,06
315	6	05 84 315 RM	G	22,3	1	10	32738	4.238,78

UP. 84. SS. VI. RM

C03 | VMA 550

O-Ring in FPM
perno in acciaio inox

FPM O-Rings
stainless steel shaft

SIZE	PN	REF.	PACK	kg	Q(B)	Q(P)	CODE	EUR
63-75	10	05 84 075 VRM	C	2,7	1	60	34473	897,68
90	10	05 84 090 VRM	C	2,7	1	60	34474	955,01
110	10	05 84 110 VRM	C	3,3	1	60	34475	1.100,79
125-140	10	05 84 140 VRM	D	4,3	1	30	34476	1.280,78
160	10	05 84 160 VRM	E	5,2	1	36	34477	1.747,12
200-225	10	05 84 200 VRM	E	10,8	1	15	34478	2.635,57
250-280	6	05 84 250 VRM	F	18,2	1	10	34479	4.395,31
315	6	05 84 315 VRM	G	22,3	1	15	32739	5.298,41

VALVOLE SELETRICI IN PVC-U - PVC-U ROTARY DISC VALVES

UP. 90. 2V

C03 | VAL 355



VALVOLA SELETRICE 2 VIE
incollaggio

2-WAY ROTARY DISC VALVE
solvent socket - SI

SIZE	PN	REF.	PACK	kg	Q(B)	Q(P)	CODE	EUR
50 - 63	6	05 90 720	D	4,4	8 (1)	240	16059	50,28

UP. 90. 3V

C03 | VAL 355



VALVOLA SELETRICE 3 VIE
incollaggio

3-WAY ROTARY DISC VALVE
solvent socket - SI

SIZE	PN	REF.	PACK	kg	Q(B)	Q(P)	CODE	EUR
50 - 63	6	05 90 730	D	5,2	8 (1)	240	15765	62,87
63 - 75	6	05 90 740	D	4,0	4 (1)	120	41862	75,67

VALVOLE DI SPURGO - DRAIN VALVES

ABS. 90. MT

C03 | VAL 390



VALVOLA DI SPURGO IN ABS
filetto maschio x portagomma

ABS DRAIN VALVE
BSP male thread x spigot connection

SIZE	PN	REF.	PACK	kg	Q(B)	Q(P)	CODE	EUR
1/4"	6	05 90 612	B	1,6	200 (20)	24000	11656	4,64

UP. 90. MT

C03 | VAL 360



VALVOLA DI SPURGO IN PVC
filetto maschio x femmina

PVC DRAIN VALVE
BSP male x female thread

SIZE	PN	REF.	PACK	kg	Q(B)	Q(P)	CODE	EUR
3/4"	10	05 90 625	B	2,8	80 (10)	9600	02579	7,28

VALVOLE A GHIGLIOTTINA IN PVC-U - PVC-U KNIFE GATE VALVES

UP. 79. SF

C03 | VGU 850

VALVOLA A GHIGLIOTTINA
 incollaggio femmina

KNIFE GATE VALVE
 solvent socket x solvent socket

SIZE	PN	REF.	PACK	kg	Q(B)	Q(P)	CODE	EUR
50 x 50	3,5	05 79 050	B	2,6	8	960	28590	24,69
63 x 63	3,5	05 79 063	C	5,2	12	720	28600	36,37
90 x 90	1,5	05 79 090	D	8,0	3	90	43577	124,99
110 x 110	1,5	05 79 110	D	5,6	2	60	43578	133,53

UP. 79. SFSP1

C03 | VGU 850

VALVOLA A GHIGLIOTTINA
 incollaggio x portagomma

KNIFE GATE VALVE
 solvent socket x spigot

SIZE	PN	REF.	PACK	kg	Q(B)	Q(P)	CODE	EUR
50 x 50	3,5	05 79 150	B	2,8	8	960	28934	24,69
50 x 38	3,5	05 79 151	B	2,7	8	960	28935	24,69
63 x 63	3,5	05 79 163	C	5,4	12	720	28936	36,37

UP. 79. SPI

C03 | VGU 850

VALVOLA A GHIGLIOTTINA
 portagomma x portagomma

KNIFE GATE VALVE
 spigot x spigot

SIZE	PN	REF.	PACK	kg	Q(B)	Q(P)	CODE	EUR
38 x 38	3,5	05 79 438	B	2,1	6	720	31441	24,69
50 x 50	3,5	05 79 450	B	2,3	6	720	28598	24,69
50 x 38	3,5	05 79 451	B	3,0	8	960	28597	24,69
63 x 63	3,5	05 79 463	C	5,5	12	720	28607	36,37

UP. 79. MT

C03 | VGU 850

VALVOLA A GHIGLIOTTINA
 filetto maschio x filetto maschio

KNIFE GATE VALVE
 male thread x male thread

SIZE	PN	REF.	PACK	kg	Q(B)	Q(P)	CODE	EUR
1½" x 1½"	3,5	05 79 250	B	2,7	8	960	28595	24,69
2" x 2"	3,5	05 79 263	C	5,3	12	720	28605	36,37

UP. 79. MTSF

C03 | VGU 850

VALVOLA A GHIGLIOTTINA
 filetto maschio x incollaggio fem.

KNIFE GATE VALVE
 male thread x solvent socket

SIZE	PN	REF.	PACK	kg	Q(B)	Q(P)	CODE	EUR
1½" x 50	3,5	05 79 335	B	2,8	8	960	28937	24,69
2" x 63	3,5	05 79 336	C	5,6	12	720	28938	36,37

UP. 79. MTSPI

C03 | VGU 850

VALVOLA A GHIGLIOTTINA
 filetto maschio x portagomma

KNIFE GATE VALVE
 male thread x spigot

SIZE	PN	REF.	PACK	kg	Q(B)	Q(P)	CODE	EUR
1½" x 50	3,5	05 79 550	B	2,8	8	960	28939	24,69
1½" x 38	3,5	05 79 551	B	2,8	8	960	28940	24,69
2" x 63	3,5	05 79 563	B	2,7	6	720	28941	36,37

UP. 79. FT

C03 | VGU 850

VALVOLA A GHIGLIOTTINA
 filetto femmina

KNIFE GATE VALVE
 female thread x female thread

SIZE	PN	REF.	PACK	kg	Q(B)	Q(P)	CODE	EUR
1½" x 1½"	3,5	05 79 650	B	2,8	8	960	28593	25,78
2" x 2"	3,5	05 79 663	C	5,8	12	720	28603	40,11

UP. 79. MFT

C03 | VGU 850

VALVOLA A GHIGLIOTTINA
 filetto femmina x filetto maschio

KNIFE GATE VALVE
 female thread x male thread

SIZE	PN	REF.	PACK	kg	Q(B)	Q(P)	CODE	EUR
1½" x 1½"	3,5	05 79 750	B	2,9	8	960	28942	25,19
2" x 2"	3,5	05 79 763	C	5,3	12	720	28943	38,07

Accessori PVC-U

Valvole PVC-U

Accessori PVC-C

Valvole PVC-C

Valvole Extreme

Evacuazione

Ricambi

VALVOLE A GHIGLIOTTINA IN PVC-U - PVC-U KNIFE GATE VALVES

UP. 79. FTSF

C03 | VGU 850



VALVOLA A GHIGLIOTTINA
filetto femmina x incollaggio fem.

SIZE	PN	REF.	PACK	kg	Q(B)	Q(P)	CODE	EUR
1½" x 50	3,5	05 79 850	B	2,7	8	960	28944	25,19
2" x 63	3,5	05 79 863	C	5,5	12	720	28945	38,07

KNIFE GATE VALVE
female thread x solvent socket

UP. 79. FTSPI

C03 | VGU 850



VALVOLA A GHIGLIOTTINA
filetto femmina x portagomma

SIZE	PN	REF.	PACK	kg	Q(B)	Q(P)	CODE	EUR
1½" x 50	3,5	05 79 950	B	2,9	8	960	28946	25,19
1½" x 38	3,5	05 79 951	B	2,8	8	960	28947	25,19
2" x 63	3,5	05 79 963	B	1,9	4	480	28948	38,07

KNIFE GATE VALVE
female thread x spigot

UP. 79. SM

C03 | VGU 850



VALVOLA A GHIGLIOTTINA
incollaggio maschio

SIZE	PN	REF.	PACK	kg	Q(B)	Q(P)	CODE	EUR
63 x 63	3,5	05 79 363	C	5,2	12	720	70922	55,62

KNIFE GATE VALVE
male solvent socket

VALVOLE A SEDE INCLINATA REGOLATRICE IN PVC-U - PVC-U ANGLE SEAT REGULATOR VALVES

UP. 75. SF

C03 | VAI 710

VALVOLA REGOLATRICE
 incollaggio

SIZE	PN	REF.	PACK	kg	Q(B)	Q(P)	CODE	EUR
20	16	05 75 020	B	1,2	8 (4)	960	22884	44,25

HDPE - EPDM
 solvent socket

UP. 75. 3SF

C03 | VAI 710

VALVOLA REGOLATRICE
 unione a tre pezzi

SIZE	PN	REF.	PACK	kg	Q(B)	Q(P)	CODE	EUR
20	16	05 75 120	B	1,3	6 (3)	720	22885	52,39

HDPE - EPDM
 union end connector

UP. 75. SM

C03 | VAI 710

VALVOLA REGOLATRICE
 incollaggio maschio

SIZE	PN	REF.	PACK	kg	Q(B)	Q(P)	CODE	EUR
20	16	05 75 220	B	1,2	8 (4)	960	22886	44,25

HDPE - EPDM
 male solvent socket

UP. 75. MT

C03 | VAI 710

VALVOLA REGOLATRICE
 filetto maschio

SIZE	PN	REF.	PACK	kg	Q(B)	Q(P)	CODE	EUR
¾" (DN 15)	16	05 75 425	B	1,6	10 (5)	1200	22887	44,25

HDPE - EPDM
 BSP male thread

VALVOLE A SEDE INCLINATA ANTIRITORNO IN PVC-U - PVC-U ANGLE SEAT CHECK VALVES

UP. 77. SF

C03 | VAI 710

VALVOLA ANTIRITORNO
 incollaggio

SIZE	PN	REF.	PACK	kg	Q(B)	Q(P)	CODE	EUR
20	16	05 77 020	B	2,4	20 (10)	2400	22889	38,43

EPDM
 solvent socket

UP. 77. 3SF

C03 | VAI 710

VALVOLA ANTIRITORNO
 unione a tre pezzi

SIZE	PN	REF.	PACK	kg	Q(B)	Q(P)	CODE	EUR
20	16	05 77 120	B	2,1	12 (6)	1440	22890	46,25

EPDM
 union end connector

UP. 77. SM

C03 | VAI 710

VALVOLA ANTIRITORNO
 incollaggio maschio

SIZE	PN	REF.	PACK	kg	Q(B)	Q(P)	CODE	EUR
20	16	05 77 220	B	2,7	24 (12)	2880	22891	38,43

EPDM
 male solvent socket

UP. 77. MT

C03 | VAI 710

VALVOLA ANTIRITORNO
 filetto maschio

SIZE	PN	REF.	PACK	kg	Q(B)	Q(P)	CODE	EUR
¾" (DN 15)	16	05 77 425	B	3,0	24 (12)	2880	22892	38,43

EPDM
 BSP male thread

RACCOGLITORE DI IMPURITA' IN PVC-U - PVC-U LINE STRAINER

UP. 76. SF

C03 | VAI 710



RACCOGLITORE DI IMPURITA'
incollaggio

EPDM
solvent socket

SIZE	PN	REF.	PACK	kg	Q(B)	Q(P)	CODE	EUR
20	16	05 76 020	B	2,2	20 (10)	2400	25713	30,46

UP. 76. 3SF

C03 | VAI 710



RACCOGLITORE DI IMPURITA'
unione a tre pezzi

EPDM
union end connector

SIZE	PN	REF.	PACK	kg	Q(B)	Q(P)	CODE	EUR
20	16	05 76 120	B	2,0	12 (6)	1440	25714	38,43

UP. 76. SM

C03 | VAI 710



RACCOGLITORE DI IMPURITA'
incollaggio maschio

EPDM
male solvent socket

SIZE	PN	REF.	PACK	kg	Q(B)	Q(P)	CODE	EUR
20	16	05 76 220	B	2,5	24 (12)	2880	25715	30,46

UP. 76. MT

C03 | VAI 710



RACCOGLITORE DI IMPURITA'
filetto maschio

EPDM
BSP male thread

SIZE	PN	REF.	PACK	kg	Q(B)	Q(P)	CODE	EUR
¾" (DN 15)	16	05 76 425	B	2,0	20 (10)	2400	25716	30,46

VALVOLE DI SFIATO ARIA IN PVC-U - PVC-U AIR/VACUUM RELIEF VALVES

UP. 90. DE

C03 | VVE 810



VALVOLA DI SFIATO ARIA
filetto maschio

AIR/VACUUM RELIEF VALVE
BSP male thread

SIZE	PN	REF.	PACK	kg	Q(B)	Q(P)	CODE	EUR
1½"	12	05 90 850	B	2,1	6	720	22803	68,91

VALVOLE A SFERA SERIE INDUSTRIAL ATTUATE IN PVC-U - PVC-U ACTUATED BALL VALVES INDUSTRIAL SERIES

INDUSTRIAL SERIES

C03



Valvola Serie INDUSTRIAL PVC-U
Industrial Series ball valves PVC-U - 2 ways

Manicotto a incollaggio
Solvent socket connectors (other connections also available)

PTFE - EPDM

	ATTUATORE ELETTRICO Electric actuation		ATTUATORE ELETTRICO con blocco di sicurezza Electric actuation & BSR safety block	ATTUATORE PNEUMATICO alluminio Pneumatic actuation aluminum		ATTUATORE PNEUMATICO alluminio + kit (*) Pneumatic actuation aluminum & kit (*)	
	24 V AC / DC	85 - 240 V AC / DC	24 - 240 V AC / DC	Doppio effetto Double acting	Semplice effetto Spring return	Doppio effetto Double acting	Semplice effetto Spring return
D16 - 3/8"	29490 956,21	31420 956,21	26417 2.439,65	26425 606,38	26433 793,42	26421 1.368,82	26429 1.342,56
D20 - 1/2"	29491 956,21	31421 956,21	05366 2.439,65	05390 606,38	05414 793,42	02648 1.368,82	05304 1.342,56
D25 - 3/4"	29492 962,67	31422 962,67	05367 2.454,66	05391 617,10	05415 804,15	02649 1.375,93	05305 1.346,87
D32 - 1"	29493 972,43	31423 972,43	05368 2.462,37	05392 718,32	05416 893,13	02650 1.253,47	05306 1.447,31
D40 - 1 1/4"	29494 988,99	31424 988,99	05369 2.483,36	05393 725,62	05417 900,58	02651 1.263,05	05307 1.456,88
	24 - 240 V AC / DC		24 - 240 V AC / DC				
D50 - 1 1/2"	02628 1.301,73		05370 2.487,89	05394 737,48	05418 1.136,66	02652 1.291,44	05308 1.698,85
D63 - 2"	02629 1.403,50		05371 2.521,96	05395 751,96	05419 1.141,05	02653 1.294,84	05309 1.698,18
D75 - 2 1/2"	02630 2.035,92		05372 3.176,92	05396 1.079,89	05420 1.779,61	02654 1.609,70	05310 2.343,06
D90 - 3"	02631 2.570,52		05373 3.677,47	05397 1.159,89	05421 1.874,14	02655 1.748,82	05311 2.471,62
D110 - 4"	26415 3.724,18		26419 5.105,58	26427 1.837,19	26435 3.102,35	26423 2.491,23	26431 3.691,60

PTFE - FPM

	ATTUATORE ELETTRICO Electric actuation		ATTUATORE ELETTRICO con blocco di sicurezza Electric actuation & BSR safety block	ATTUATORE PNEUMATICO alluminio Pneumatic actuation aluminum		ATTUATORE PNEUMATICO alluminio + kit (*) Pneumatic actuation aluminum & kit (*)	
	24 V AC / DC	85 - 240 V AC / DC	24 - 240 V AC / DC	Doppio effetto Double acting	Semplice effetto Spring return	Doppio effetto Double acting	Semplice effetto Spring return
D16 - 3/8"	29570 962,16	31425 962,16	29600 2.457,58	29913 616,59	29923 810,25	29933 1.369,87	29943 1.348,51
D20 - 1/2"	29571 962,16	31426 962,16	29601 2.457,58	29914 616,59	29924 810,25	29934 1.369,87	29944 1.348,51
D25 - 3/4"	29572 972,58	31427 972,58	29602 2.475,99	29915 621,65	29925 811,59	29935 1.375,97	29945 1.356,75
D32 - 1"	29573 983,99	31428 983,99	29603 2.490,47	29916 728,69	29926 902,42	29936 1.265,01	29946 1.458,85
D40 - 1 1/4"	29574 1.005,74	31429 1.005,74	29604 2.514,87	29917 731,08	29927 915,93	29937 1.279,79	29947 1.473,63
	24 - 240 V AC / DC		24 - 240 V AC / DC				
D50 - 1 1/2"	29585 1.350,00		29605 2.536,15	29918 766,44	29928 1.185,04	29938 1.317,74	29948 1.715,26
D63 - 2"	29586 1.414,88		29606 2.555,90	29919 783,69	29929 1.208,60	29939 1.341,53	29949 1.748,84
D75 - 2 1/2"	29587 2.091,71		29607 3.232,71	29920 1.136,35	29930 1.857,69	29940 1.656,91	29950 2.421,93
D90 - 3"	29588 2.624,70		29608 3.732,48	29921 1.241,10	29931 1.962,41	29941 1.836,08	29951 2.566,00
D110 - 4"	29589 3.803,85		29609 5.185,29	29922 1.934,97	29932 3.212,61	29942 2.595,48	29952 3.807,65

* KIT = Elettrovalvola 220V + box fine corsa e silenziatori di sfianto aria

Kit: 220V electric valve, limit-switch box and relief regulators

* Le valvole pneumatiche se non specificato si forniscono NC (Normalmente chiuse).

Se si desidera una configurazione NA (Normalmente Aperta) si prega di indicarlo nell'ordine.

* Pneumatic valves are shipped as NC (Normally closed) as standard.

If a NO (Normally open) configuration is needed, please specify when placing the order.

**VALVOLE A FARFALLA SERIE INDUSTRIAL ATTUATE IN PVC-U -
PVC-U ACTUATED BUTTERFLY VALVES INDUSTRIAL SERIES**

C03

Valvola a farfalla PVC-U - perno acciaio inox
Butterfly valves Industrial Series PVC-U - stainless steel shaft

	EPDM
Perox.	Perox.

	ATTUATORE ELETTRICO Electric actuation		ATTUATORE PNEUMATICO alluminio Pneumatic actuation aluminum		ATTUATORE PNEUMATICO alluminio + kit (*) Pneumatic actuation aluminum & kit (*)	
	24 - 240 V AC / DC	ATTUATORE ELETTRICO con blocco di sicurezza Electric actuation & BSR safety block 24 - 240 V AC / DC	Doppio effetto Double acting	Semplice effetto Spring return	Doppio effetto Double acting	Semplice effetto Spring return
D63 - D75	30272 1.995,14	30286 2.930,94	30464 1.101,43	30471 1.481,05	30478 1.667,24	30485 2.043,45
D90	30273 2.033,00	30287 3.193,73	30465 1.134,63	30472 1.755,73	30479 1.683,12	30486 2.396,30
D110	30274 2.544,22	30288 3.647,46	30466 1.163,58	30473 1.812,30	30480 1.754,89	30487 2.425,23
D125 - D140	30275 3.482,31	30289 4.824,66	30467 1.698,07	30474 2.798,71	30481 2.311,10	30488 3.411,61
D160	30276 3.543,58	30290 4.885,94	30468 1.764,49	30475 2.863,25	30482 2.377,48	30489 3.483,53
D200 - D225	30277 4.493,03	30291 5.998,83	30469 2.243,48	30476 3.270,25	30483 2.936,84	30490 3.884,62
D250 - D280	30278 5.171,68	30292 7.027,42	30470 3.514,48	30477 4.244,00	30484 4.088,75	30491 4.860,32
D315	32742 5.977,28	32744 7.707,45	32755 4.798,18	32757 9.141,83	32756 5.279,51	32758 9.812,87

	FPM
--	-----

	ATTUATORE ELETTRICO Electric actuation		ATTUATORE PNEUMATICO alluminio Pneumatic actuation aluminum		ATTUATORE PNEUMATICO alluminio + kit (*) Pneumatic actuation aluminum & kit (*)	
	24 - 240 V AC / DC	ATTUATORE ELETTRICO con blocco di sicurezza Electric actuation & BSR safety block 24 - 240 V AC / DC	Doppio effetto Double acting	Semplice effetto Spring return	Doppio effetto Double acting	Semplice effetto Spring return
D63 - D75	30336 2.086,80	30350 3.227,80	30517 1.153,68	30524 1.533,40	30531 1.806,66	30538 2.186,32
D90	30337 2.150,20	30351 3.321,36	30518 1.237,36	30525 1.858,47	30532 1.810,76	30539 2.498,96
D110	30338 2.712,63	30352 3.814,84	30519 1.329,18	30526 1.977,84	30533 1.969,71	30540 2.590,81
D125 - D140	30339 3.751,02	30353 5.132,45	30520 1.884,46	30527 2.943,48	30534 2.455,93	30541 3.556,49
D160	30340 3.923,28	30354 5.304,70	30521 2.005,91	30528 3.104,77	30535 2.618,92	30542 3.717,76
D200 - D225	30341 4.899,59	30355 6.548,59	30522 2.789,61	30529 3.775,69	30536 3.321,62	30543 4.269,41
D250 - D280	30342 6.232,70	30356 7.881,70	30523 4.369,96	30530 5.141,47	30537 4.982,96	30544 5.754,51
D315	32749 7.104,91	32751 8.665,40	32759 5.697,35	32761 10.099,77	32760 6.180,59	32762 10.770,85

* **KIT = Electrovalvola 220V + box fine corsa e silenziatori sfianto aria**

Kit: 220V electric valve, limit-switch box and relief regulators

ATTENZIONE:

* **Le valvole pneumatiche se non specificato si forniscono NC (Normalmente chiuse).**

Se si desidera una configurazione NA (Normalmente Aperta) si prega di indicarlo nell'ordine.

* Pneumatic valves are shipped as NC (Normally closed) as standard.

If a NO (Normally open) configuration is needed, please specify when placing the order.

STD SERIES

NEW STD BUTTERFLY VALVE ELECTRIC ACTUATOR

Best value for your money



- New **CEPEX** development
- Specially designed for commercial swimming pools - automatic battery valves for big filters
- Best **quality-price** relation with the warranty of the **Cepex Quality System**
- Valve completely made in PVC-U; o-rings in EPDM; zinc plated steel shaft - **Corrosion FREE**
- Impact and UV resistant
- Compatible with all the installation standards - ISO/DIN, BSi, ANSI, JIS
- Actuator with multivoltage (24-240 VAC-VDC) and protection degree IP67

C03 | VMA 533



O-ring in EPDM
perno in acciaio zincato

EPDM O-Rings
zinc plated steel shaft

NEW

SIZE	PN	REF.	PACK	kg	Q(B)	Q(P)	CODE	EUR
63-75	10	05 83 075 09J	0,05	3,1	1	-	72267	1.721,68
90	10	05 83 090 09J	0,05	3,8	1	-	72268	1.744,25
110	10	05 83 110 09J	0,05	4,6	1	-	72269	1.930,84
125-140	10	05 83 140 09J	0,08	6,0	1	-	72270	2.507,64
160	10	05 83 160 09J	0,08	9,3	1	-	72273	3.115,15
200-225	10	05 83 200 09J	0,08	11,5	1	-	72274	3.412,34
250-280	6	05 83 250 09J	0,15	16,4	1	-	72275	4.827,82
315	6	05 83 315 09J	0,15	26,3	1	-	72276	5.246,48

RICAMBI: KIT DI ATTUAZIONE VALVOLE A SFERA
SPARE PARTS: ACTUATION KITS FOR BALL VALVES

C03



Kit attuazione

Actuation Kits

ATTUATORE ELETTRICO Electric actuation		ATTUATORE ELETTRICO ER / VS Electric actuation ER / VS	
Senza BSR Without BSR	Con BSR With BSR	100 - 240V AC	15-30V AC / DC

ATTUATORE PNEUMATICO alluminio Pneumatic actuation aluminum		ATTUATORE PNEUMATICO poliammide Pneumatic actuation polyamide	
Doppio effetto Double acting	Semplice effetto Spring return	Doppio effetto Double acting	Semplice effetto Spring return

Valvola a sfera Industriale
2-way ball valves

Includono bussola di connessione, supporto attuatore e viti, supporto e accoppiamenti nei diametri richiesti.
Includes coupling bush, supports, bolts, mounting clamp and connectors in required sizes.

INDUSTRIAL Series



D16 - 3/8"	30570 97,27	56852 97,23	30580 97,23
D20 - 1/2"	30571 97,27	56853 97,23	30581 97,23
D25 - 3/4"	30572 96,15	56854 96,07	30582 96,07
D32 - 1"	30573 100,44	56855 100,39	30583 100,28
D40 - 1 1/4"	30574 99,60	56856 99,54	30584 99,45
D50 - 1 1/2"	30575 107,54	30585 107,43	30585 107,43
D63 - 2"	30576 105,19	30586 105,08	30586 105,08
D75 - 2 1/2"	30577 116,45	30587 162,00	30587 162,00
D90 - 3"	30578 155,41	30588 153,88	30588 153,88
D110 - 4"	30579 154,04	30589 165,03	30589 165,03

30590 96,23	30600 97,23	30610 96,77	30620 96,77
30591 96,23	30601 97,23	30611 96,77	30621 96,77
30592 95,74	30602 93,88	30612 95,64	30622 95,59
30593 99,91	30603 99,91	30613 100,28	30623 100,28
30594 99,14	30604 99,14	30614 99,45	30624 99,45
30595 107,13	30605 108,63	30615 107,43	30625 108,63
30596 106,39	30606 107,80	30616 105,19	30626 107,80
30597 116,45	30607 116,45	30617 116,45	30627 162,00
30598 155,41	30608 155,41	30618 155,87	30628 153,88
30599 155,56	30609 151,07	30619 154,04	

Valvola a sfera [IND]
[IND] 2-way ball valves

Includono bussola di connessione, supporto attuatore e viti, supporto e accoppiamenti nei diametri richiesti.
Includes coupling bush, supports, bolts, mounting clamp and connectors in required sizes.

IND Series



D16 - 3/8"	53944 92,60	43676 89,66	43676 89,66
D20 - 1/2"	53944 92,60	43676 89,66	43676 89,66
D25 - 3/4"	53945 92,86	43677 92,78	43677 92,78
D32 - 1"	53946 95,37	43678 95,31	43678 95,31
D40 - 1 1/4"	53947 95,24	43679 95,18	69581 96,60
D50 - 1 1/2"	43680 98,22	43680 98,22	43680 98,22
D63 - 2"	43681 97,64	43681 97,64	43681 97,64
D75 - 2 1/2"	43682 103,53	46667 103,53	46667 103,53
D90 - 3"	43683 104,24	46668 104,22	46668 104,22
D110 - 4"	30579 154,04	30589 165,03	30589 165,03

43684 91,43	43690 92,53	43702 91,94	43702 91,94
43684 91,43	43690 92,53	43702 91,94	43702 91,94
43685 92,32	43691 90,60	43703 92,30	43703 92,30
43686 94,82	43686 94,82	43704 95,31	43704 95,31
43687 94,73	43687 94,73	43705 129,83	43705 129,83
43688 97,81	43692 99,31	43706 98,22	43714 167,59
43689 98,84	43693 100,27	43707 97,64	43715 168,31
43682 103,53	43682 103,53	43708 103,53	55197 232,03
43683 104,24	43683 104,24	43709 104,22	55198 149,74
30599 155,56	30609 151,07	30619 154,04	

Valvola a sfera a 3 vie
3-way ball valves

Includono bussola di connessione, supporto attuatore e viti.
Includes coupling bush, support, bolts and inserts.

D50 - 1 1/2"	30629 CONSULTARE	30630 CONSULTARE
--------------	----------------------------	----------------------------

30843 CONSULTARE	30844 CONSULTARE	30631 CONSULTARE	30632 CONSULTARE
----------------------------	----------------------------	----------------------------	----------------------------

Accessori PVC-U

Valvole PVC-U

Accessori PVC-C

Valvole PVC-C

Valvole Extreme

Evacuazione

Ricambi

RICAMBI: KIT DI ATTUAZIONE VALVOLE A FARFALLA
SPARE PARTS: ACTUATION KITS FOR BUTTERFLY VALVES

C03 | 007 999

Accessori PVC-U

Valvole PVC-U

Accessori PVC-C

Valvole PVC-C

Valvole Extreme

Evacuazione

Ricambi



Kit attuazione Actuation Kits	ATTUATORE ELETTRICO Electric actuation		ATTUATORE ELETTRICO ER / VS Electric actuation ER / VS		ATTUATORE PNEUMATICO alluminio Pneumatic actuation aluminum		ATTUATORE PNEUMATICO poliammida Pneumatic actuation polyamide		Riduttore manuale Gear operator	
	24-240V AC / DC		100 - 240V AC		15-30V AC / DC		Doppio effetto Double acting		Semplice effetto Spring return	
	24-240V AC / DC		100 - 240V AC		15-30V AC / DC		Doppio effetto Double acting		Semplice effetto Spring return	

Valvola a Farfalla Butterfly valves
 Includono bussola di connessione, supporto attuatore e viti, supporto e accoppiamenti nei diametri richiesti.
 Includes coupling bush, supports, bolts, mounting clamp and connectors in required sizes.

CLASSIC Series

D63 - D75	30633 168,67	30640 224,02	30647 168,67	30654 168,67	30661 166,67	30667 223,87		08976KIT 198,38
D90	30634 168,54	30641 223,89	30648 168,67	30655 168,67	30662 168,67	30668 214,08		08977KIT 198,38
D110	30635 168,54	30642 222,26	30649 168,67	30656 168,67	30663 168,67	30669 222,10		08978KIT 198,38
D125 - D140	30636 168,67	30643 224,02	30650 168,67	30657 168,67	30664 222,23			08979KIT 199,35
D160	30637 168,67	30644 224,90	30651 168,67	30658 168,67	30665 267,78			08980KIT 199,35
D200 - D225	30638 * 476,80	30638 * 476,80	30652 * 435,85	30659 * 323,18	30666 * 438,20			08982KIT * 241,14
D250	30639 ** 109,96	30646 109,96	30653 109,96	30660 109,96			16063KIT 99,27	16062KIT 246,69

Valvola a Farfalla Butterfly valves
 Includono bussola di connessione, supporto attuatore e viti, supporto e accoppiamenti nei diametri richiesti.
 Includes coupling bush, supports, bolts, mounting clamp and connectors in required sizes.

IND Series



D63 - D75	57498 103,02	46669 148,57	35898 103,00	35898 103,00	35922 103,05	55185 148,61		35899 103,07
D90	35901 103,07	46670 148,61	57497 103,01	35901 103,07	35923 103,05	55186 148,61		35902 103,07
D110	35901 103,07	46670 148,61	57497 103,01	35901 103,07	35924 103,05	55187 148,61		35902 103,07
D125 - D140	69632 104,60	54591 103,07	35905 103,07	35904 103,07	35925 103,05			35906 103,07
D160	69632 104,60	54591 103,07	35905 103,07	35904 103,07	35925 103,05			56816 103,07
2200 - D225	35908 227,16	69785 227,15	35909 340,31	69785 227,15	35926 223,76			35910 223,70
2250 - D280	35912 240,05	35912 240,05	35912 240,05	35912 240,05			35911 99,04	35915 138,56
D315	35912 240,05	35912 240,05	35912 240,05	35914 353,20			35911 99,04	35915 138,56

attuazione Actuation Kits	ATTUATORE ELETTRICO Electric actuation	
	24-240V AC / DC	
	24-240V AC / DC	

Valvola a Farfalla Butterfly valves
 Includono bussola di connessione, supporto attuatore e viti, supporto e accoppiamenti nei diametri richiesti.
 Includes coupling bush, supports, bolts, mounting clamp and connectors in required sizes.

STD Series



D63 - D75	74239 182,86
D90	74240 182,86
D110	35901 103,07
D125 - D140	69632 104,60
D160	69632 104,60
2200 - D225	35908 227,16
2250 - D280	35912 240,05
D315	35912 240,05

* Kit in acciaio inossidabile.
Stainless steel kit

** Senza adattatore di connessione (non necessario).
Without connection adapter (not needed).

RICAMBI: ATTUATORI (SENZA KIT) E RIDUTTORI MANUALI
SPARE PARTS: ACTUATOR (WITHOUT KIT) AND GEAR BOX

C03 | 007 999



Attuatore Include solo l'attuatore (senza kit di montaggio)
Actuators Including actuator only (without mounting kit)

Valvola a sfera a 2 vie
2-way ball valves

	J+J		VALPES		CH-air		Primo	
	ATTUATORE ELETTRICO		ATTUATORE ELETTRICO		ATTUATORE PNEUMATICO		ATTUATORE PNEUMATICO	
	Electric actuation		Electric actuator		Pneumatic actuation		Pneumatic actuator	
	12 - 24 V	85 - 240 V	100-240V	15-30 V	alluminio	alluminio	poliammida	poliammida
	AC / DC	AC / DC	AC	AC/DC	aluminum	aluminum	polyamide	polyamide
					Doppio effetto	Semplice effetto	Doppio effetto	Semplice effetto
					Double acting	Spring return	Double acting	Spring return
D16 - 3/4"	30671 802,46	30676 802,46	30682 1.673,95	30692 1.545,10	30706 443,25	30712 652,31	30719 443,30	30724 494,93
D20 - 1/2"	30671 802,46	30676 802,46	30682 1.673,95	30692 1.545,10	30706 443,25	30712 652,31	30719 443,30	30724 494,93
D25 - 3/4"	30671 802,46	30676 802,46	30682 1.673,95	30692 1.545,10	30706 443,25	30712 652,31	30719 443,30	30724 494,93
D32 - 1"	30671 802,46	30676 802,46	30682 1.673,95	30692 1.545,10	30707 544,34	30713 742,13	32364 636,42	30725 740,39
D40 - 1 1/4"	30671 802,46	30676 802,46	30682 1.673,95	30692 1.545,10	30707 544,34	30713 742,13	32364 636,42	30725 740,39
	24 - 240 V AC / DC		100-240V AC	15-30 V AC/DC	Doppio effetto Double acting	Semplice effetto Spring return	Doppio effetto Double acting	Semplice effetto Spring return
D50 - 1 1/2"	46652 1.161,84	30682 1.673,95	30682 1.673,95	30692 1.545,10	30707 544,34	30714 954,07	32364 636,42	30726 977,61
D63 - 2"	46652 1.161,84	30682 1.673,95	30682 1.673,95	30692 1.545,10	30707 544,34	30714 954,07	32364 636,42	30726 977,61
D75 - 2 1/2"	30677 1.717,36	30683 2.762,50	30683 2.762,50	30693 2.634,30	30708 793,95	30715 1.403,21	30720 845,39	30727 1.374,09
D90 - 3"	46654 2.128,42	30683 2.762,50	30683 2.762,50	30693 2.634,30	30708 793,95	30715 1.403,21	30720 845,39	30727 1.374,09
D110 - 4"	30678 2.773,46	30684 5.070,91	30684 5.070,91	30694 4.757,79	30709 1.163,71	30716 2.229,18	30721 1.189,79	

Valvola a sfera a 3 vie
3-way ball valves

	J+J		VALPES		CH-air		Primo	
	ATTUATORE ELETTRICO		ATTUATORE ELETTRICO		ATTUATORE PNEUMATICO		ATTUATORE PNEUMATICO	
	Electric actuation		Electric actuator		Pneumatic actuation		Pneumatic actuator	
	24 - 240 V	100-240V	15-30 V					
	AC / DC	AC	AC/DC	aluminum	aluminum	polyamide	polyamide	
					Doppio effetto	Semplice effetto	Doppio effetto	Semplice effetto
					Double acting	Spring return	Double acting	Spring return
D50 - 1 1/2"	30681 1.177,89	30686 1.510,55	30696 1.545,10	30711 1.617,22	30718 2.086,57	30723 2.189,00	30728 2.266,05	



Valvola a farfalla
Butterfly valves

	J+J		VALPES		CH-air		Primo		Riduttore manuale	
	ATTUATORE ELETTRICO		ATTUATORE ELETTRICO		ATTUATORE PNEUMATICO		ATTUATORE PNEUMATICO		Gear operated	
	Electric actuation		Electric actuator		Pneumatic actuation		Pneumatic actuator		IND Series Classic Series	
	24 - 240 V	100-240V	24 V							
	AC / DC	AC	AC/DC	aluminum	aluminum	polyamide	polyamide	IND Series	Classic Series	
					Doppio effetto	Semplice effetto	Doppio effetto	Semplice effetto		
					Double acting	Spring return	Double acting	Spring return		
D63 - D75	30677 1.717,36	30683 2.762,50	30693 2.634,30	30708 793,95	43288 1.134,37	30720 845,39	30727 1.374,09	54744 441,83	TBD	
D90	30677 1.717,36	30683 2.762,50	30693 2.634,30	30708 793,95	30715 1.403,21	30720 845,39	30727 1.374,09	54744 441,83	TBD	
D110	46654 2.128,42	30683 2.762,50	30693 2.634,30	30708 793,95	30715 1.403,21	30720 845,39	30727 1.374,09	54744 441,83	TBD	
D125 - D140	30678 2.773,46	30684 5.070,91	30694 4.757,79	30709 1.163,71	30716 2.229,18	30721 1.189,79		54744 441,83		
D160	30678 2.773,46	30684 5.070,91	30694 4.757,79	30709 1.163,71	30716 2.229,18	30721 1.189,79		54737 745,96		
D200 - D225	30679 3.086,93	30685 4.962,46	30695 4.962,46	30709 1.163,71	30716 2.229,18	30721 1.189,79		54737 745,96		
D250 - D280	30679 3.086,93	30685 4.962,46	30695 4.962,46	30710 1.505,60	30716 2.229,18			36662 1.147,41		
D315	30679 3.086,93	30685 4.962,46	30695 4.962,46	41872 1.847,31	30717 5.858,87			36662 1.147,41		

Valvola a farfalla
Butterfly valves

	ATTUATORE ELETTRICO	
	Electric actuator	
	24 - 240 V	
	AC / DC	
D63 - D75	65342 CONSULTARE	
D90	65342 CONSULTARE	
D110	30677 1.700,61	
D125 - D140	46654 2.107,66	
D160	30678 2.746,40	
D200 - D225	30678 2.746,40	
D250 - D280	30679 3.056,81	
D315	30679 3.056,81	

IND Series

STD Series

Accessori PVC-U

Valvole PVC-U

Accessori PVC-C

Valvole PVC-C

Valvole Extreme

Evacuazione

Ricambi

ACCESSORI PER ATTUATORI - ACCESSORIES FOR ACTUATORS

C03 | 007 999

Attuazione elettrica

Attuazione elettrica
 Electric actuation

Attuatori con blocco di sicurezza
 Actuators with safety block

Valv. sfera D16 - D63	30849
Ball Valves D16 - D63	2.119,95
V. sfera D75 e V. farfalla D75-D90	30850
Ball Valves D75 & Butterfly Valves D75-D90	2.683,13
V. sfera D90 e V. farfalla D110	53834
Ball Valves D90 & Butterfly Valves D110	3.219,76
V. sfera D110 e V. farfalla D140-D160	30851
Ball Valves D110 & Butterfly Valves D140-D160	3.984,85
V. farfalla D200-D315	30852
Butterfly Valves D200-D250	4.622,43
V. sfera 3 vie D50	30862
3 way Ball Valve D50	2.142,15

Attuatori con blocco di sicurezza
 Actuators with safety block

V. farfalla STD D63-D90	73987
Butterfly v. STD D63-D90	2.538,40
V. farfalla STD D110	30850
Butterfly v. STD D110	2.683,13
V. farfalla STD D125-D140	53834
Butterfly v. STD D125-D140	3.219,76
V. farfalla STD D160-D225	30851
Butterfly v. STD D160-D225	3.984,85
V. farfalla STD D250-D315	30852
Butterfly v. STD D250-D315	4.622,43



It is possible to ask for the BSR or DPS Kit to install in an existing actuator, ask us to know the code.

Attuatori con posizionario digitale 4-20 mA
 Actuators with digital positioner 4-20 mA

Valv. sfera D16 - D63	30857
Ball Valves D16 - D63	2.026,96
V. sfera D75 e V. farfalla D75-D90	30858
Ball Valves D75 & Butterfly Valves D75-D90	2.584,83
V. sfera D90 e V. farfalla D110	10065
Ball Valves D90 & Butterfly Valves D110	3.133,24
V. sfera D110 e V. farfalla D140-D160	30859
Ball Valves D110 & Butterfly Valves D140-D160	4.516,17
V. farfalla D200-D315	30860
Butterfly Valves D200-D250	5.180,31
V. sfera 3 vie D50	30864
3 way Ball Valve D50	2.018,99

Attuatori con blocco di sicurezza e posizionario digitale
 Actuators with safety block and digital positioner

Valv. sfera D16 - D63	65276
Ball Valves D16 - D63	3.103,72
V. sfera D75 e V. farfalla D75-D90	65278
Ball Valves D75 & Butterfly Valves D75-D90	3.627,41
V. sfera D90 e V. farfalla D110	65280
Ball Valves D90 & Butterfly Valves D110	4.214,93
V. sfera D110 e V. farfalla D140-D160	65282
Ball Valves D110 & Butterfly Valves D140-D160	5.825,68
V. farfalla D200-D315	65284
Butterfly Valves D200-D250	6.169,13

Attuatori speciali 12V
 12V special actuators

Valv. sfera D16 - D63	73151
Ball Valves D16 - D63	1.215,92
V. sfera D75 e V. farfalla IND D75-D90	73152
Ball Valves D75 & IND butterfly Valves D90	1.797,30
V. sfera D90 e V. farfalla IND D110	73153
Ball Valves D90 & IND butterfly Valves D110	2.227,51

Supporti attuatori
Valvola a farfalla IND
 Butterfly valves IND

Valvola a farfalla D75 - D160	43393
Butterfly valves D75 - D160	48,02
Valvola a farfalla D200	10072
Butterfly valves D200	46,08
Supporti attuatori F07 V.farfalla D250-D315	43394
Brackets F07 Butterfly valves D250 - D315	56,53
Supporti attuatori F10 V.farfalla D250-D315	43394F10
Brackets F10 Butterfly valves D250 - D315	56,53
Supporti attuatori F12 V.farfalla D250-D315	43394F12
Brackets F12 Butterfly valves D250 - D315	56,53



Accessori PVC-U

Valvole PVC-U

Accessori PVC-C

Valvole PVC-C

Valvole Extreme

Evacuazione

Ricambi

ACCESSORI PER ATTUATORI - ACCESSORIES FOR ACTUATORS

C03 | 007 999

Attuazione pneumatica



Elettrovalvola
Solenoid valve



12V DC	30739 360,70
24V AC	30740 212,38
24V DC	30722 212,38
110V AC	30741 402,79
110V DC	30742 238,11

Elettrovalvola (Burkert)
Solenoid valve (Burkert)



230V AC	30737B 629,54
12V DC	30739B 1.125,50
24V AC	30740B 782,61
110V AC	30741B 810,21
110V DC	30742B 988,34



Elettrovalvola
Solenoid valve



oplaminetto especial electroválvula CH32 *
Special solenoid valve coupling CH32 *

230V AC	30746 370,41
12V DC	30748 370,41
24V AC	30749 370,41
24V DC	30670 370,41
110V AC	30750 370,41
110V DC	30751 370,41

69425 124,72

* Accesorio necesario para acoplamiento de electroválvula en actuador neumático simple efecto en válvulas de bola D16-D32
* Accessories required for solenoid valve coupling in spring return pneumatic actuator in ball valves D16 D32



Box fincorsa (*)
Limit switch box (*)



especial CH032

30743 297,44
30744 401,64

Silenziatore di sfogo aria (**)
Relief regulators (**)



30745 154,91

(**) Sono necessari 2 unità per attuatore (incluso).
(**) There are needed 2 per actuator (included)



Box fincorsa (*)
Limit switch box (*)



45293 331,00

Accessori PVC-U

Valvole PVC-U

Accessori PVC-C

Valvole PVC-C

Valvole Extreme

Evacuazione

Ricambi

VALVOLE SELETRICI IN PVC-U - PVC-U ROTARY DISC VALVES

C03 | VAL370

Accessori PVC-U

Valvole PVC-U

Accessori PVC-C

Valvole PVC-C

Valvole Extreme

Evacuazione

Ricambi

		ELECTRIC ROTARY DISC VALVES			
		230 VAC		24 VAC	
		90° turn	180° turn	90° turn	180° turn
D50-D63		-	41863 787,43	-	45866 787,43
D63-D75		41864 815,98	59959 815,97	43730 815,98	59960 815,97

RICAMBI DI VALVOLE SELETRICI PVC-U
SPARE PARTS PVC-U AUTOMATIC ROTARY DISC VALVES

C03 | VAL370

ATTUATORE ELETTRICO 90°
ELECTRIC ACTUATOR 90°

SIZE	PN	REF.	PACK	kg	Q(B)	Q(P)	CODE	EUR
220V AC	-	-	-	-	-	-	53933	639,16
24 V AC	-	-	-	-	-	-	53934	639,16

ATTUATORE ELETTRICO 180°
ELECTRIC ACTUATOR 180°

SIZE	PN	REF.	PACK	kg	Q(B)	Q(P)	CODE	EUR
220V AC	-	-	-	-	-	-	59965	639,16
24 V AC	-	-	-	-	-	-	59966	639,16

KIT DI ATTUAZIONE
ACTUATION KIT

SIZE	PN	REF.	PACK	kg	Q(B)	Q(P)	CODE	EUR
50-63	-	-	-	-	-	-	54436	80,79
63-75	-	-	-	-	-	-	54086	80,79

VALVOLE A 3 VIE PVC-U - PVC-U 3-WAY VALVE



Válvulas de bola 3 vías PVC-U - 3 vías
3-way Series ball valves PVC-U - 3 ways

Manguitos para encolar (otras opciones de conexión disponi
Solvent socket connectors (other connections also available)

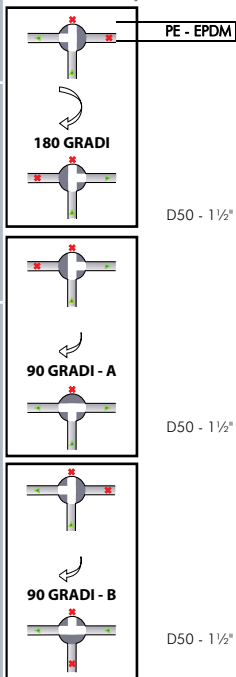

	ATTUATORE ELETTRICO Electric actuation	ATTUATORE ELETTRICO con blocco di sicurezza Electric actuation & BSR safety block
D50 - 1½"	24 - 240 V AC / DC 27227 1.349,58	24 - 240 V AC / DC 27228 2.415,95
D50 - 1½"	Actuación eléctrica Electric actuation 24 - 240 V AC / DC 71153 1.349,48	Actuación eléctrica con bloque de seguridad Electric actuation & BSR safety block 24 - 240 V AC / DC 71155 2.415,95
D50 - 1½"	Actuación eléctrica Electric actuation 24 - 240 V AC / DC 71154 1.349,48	Actuación eléctrica con bloque de seguridad Electric actuation & BSR safety block 24 - 240 V AC / DC 71156 2.415,95

3-way Series ball valves PVC-U

Solvent socket connectors (other connections e

	Actuación neumática aluminio Pneumatic actuation aluminum		Actuación neumática aluminio con kit (*) Pneumatic actuation aluminum & kit (*)	
	Doble efecto Double acting	Simple efecto Spring return	Doble efecto Double acting	Simple efecto Spring return
D50 - 1½"	27589 1.907,62	27591 2.357,13	27588 2.426,70	27590 2.875,82

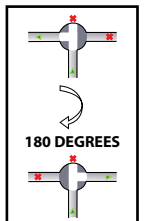

(*) KIT = Elettrovalvola 220V + box fine corsa e silenziosi sfogo aria
Kit: electric valve (220 VAC), limit-switch box and relief regulators

Le valvole pneumatiche se non specificato si forniscono NC (Normalmente chiuse).
Se si desidera una configurazione NA (Normalmente Aperta) si prega di indicarlo nell'ordine.
Pneumatic valves are shipped as NC (normally closed) as standard.
If a NO (normally open) configuration is needed, please specify when placing the order.

ACCESSORI PRESSIONE PVC-C

CPVC PRESSURE FITTINGS

- Accessori PVC-U
- Valvole PVC-U
- Accessori PVC-C
- Valvole PVC-C
- Valvole Extreme
- Evacuazione
- Ricambi

85 | Gomiti
Elbows



86 | Adattatori e manicotti nipplo
Nipples



88 | Bocchettoni
Unions



85 | Ti
Tees



87 | Flange e collari
Flanges and bolts



86 | Manicotti
Sockets



87 | Calotte
Caps



ADESIVI PVC-C - CPVC SOLVENT CEMENT

89 | Adesivi
Solvent cement



TUBO PVC-C - CPVC PIPE

89 | Tubo PVC-C
CPVC rigid pipe



GOMITI - ELBOWS**CP. 01. SF**

C19 | ACC 010

**GOMITO 90°**
incollaggio**90° ELBOW**
solvent socket

SIZE	PN	REF.	PACK	kg	Q(B)	Q(P)	CODE	EUR
16	16	36 01 016	B	1,2	100	12.000	50692	4,83
20	16	36 01 020	B	2,0	100	12.000	50693	4,83
25	16	36 01 025	B	2,1	60	7.200	50694	6,12
32	16	36 01 032	B	1,9	30	3.600	50695	6,99
40	16	36 01 040	B	2,6	24	2.880	50696	11,06
50	16	36 01 050	B	2,4	12	1.440	50697	16,56
63	16	36 01 063	C	5,6	14	840	50698	19,73
75	16	36 01 075	C	4,8	9	540	50699	39,46
90	16	36 01 090	C	5,3	6	360	50700	57,06
110	16	36 01 110	D	9,4	6	180	50701	114,16

CP. 01. SFT

C19 | ACC 030

**GOMITO 90°**
incollaggio femina x maschio**90° ELBOW**
female x male solvent socket

SIZE	PN	REF.	PACK	kg	Q(B)	Q(P)	CODE	EUR
16	16	36 29 216	B	1,0	100	12.000	50788	6,02
20	16	36 29 220	B	1,9	80	9.600	50789	6,02
25	16	36 29 225	B	2,5	60	7.200	50790	7,69
32	16	36 29 232	B	2,3	30	3.600	50791	8,75

CP. 02. SF

C19 | ACC 010

**GOMITO 45°**
incollaggio**45° ELBOW**
solvent socket

SIZE	PN	REF.	PACK	kg	Q(B)	Q(P)	CODE	EUR
16	16	36 02 016	B	1,0	100	12.000	50702	4,51
20	16	36 02 020	B	2,1	100	12.000	50703	4,83
25	16	36 02 025	B	1,7	60	7.200	50704	6,60
32	16	36 02 032	B	2,1	40	4.800	50705	8,08
40	16	36 02 040	B	2,4	27	3.240	50706	10,35
50	16	36 02 050	B	2,0	12	1.440	50707	14,71
63	16	36 02 063	B	2,5	8	960	50708	31,34
75	16	36 02 075	C	4,0	10	600	50709	34,33
90	16	36 02 090	C	4,1	6	360	50710	52,63
110	16	36 02 110	C	4,9	4	240	50711	79,74

CP. 02. SFT

C19 | ACC 030

**GOMITO 45°**
incollaggio femina x maschio**45° ELBOW**
female x male solvent socket

SIZE	PN	REF.	PACK	kg	Q(B)	Q(P)	CODE	EUR
16	16	36 30 216	B	1,0	100	12.000	50792	7,68
20	16	36 30 220	B	1,8	100	12.000	50793	8,25
25	16	36 30 225	B	1,8	60	7.200	50794	11,26
32	16	36 30 232	B	2,3	40	4.800	50795	12,43

TI - TEES**CP. 03. SF**

C19 | ACC 010

**TI 90°**
incollaggio**90° TEE**
solvent socket

SIZE	PN	REF.	PACK	kg	Q(B)	Q(P)	CODE	EUR
16	16	36 03 016	B	1,2	60	7.200	50712	5,14
20	16	36 03 020	B	1,7	60	7.200	50713	5,14
25	16	36 03 025	B	2,0	40	4.800	50714	7,41
32	16	36 03 032	B	1,8	20	2.400	50715	8,36
40	16	36 03 040	B	2,4	15	1.800	50716	13,54
50	16	36 03 050	B	2,7	9	1.080	50717	18,67
63	16	36 03 063	C	5,5	10	600	50718	31,66
75	16	36 03 075	C	4,5	6	360	50719	52,45
90	16	36 03 090	D	10,5	8	240	50720	68,03
110	16	36 03 110	D	10,7	5	150	50721	145,12

CP. 04. SFG

C19 | ACC 010

TI 90° RIDOTTA
 incollaggio

90° REDUCING TEE
 solvent socket

SIZE	PN	REF.	PACK	kg	Q(B)	Q(P)	CODE	EUR
20 x 16	16	36 04 020	B	1,6	60	7.200	50722	4,41
25 x 20	16	36 04 025	B	1,9	40	4.800	50723	6,82
25 x 16	16	36 04 026	B	1,9	40	4.800	50724	6,82
32 x 25	16	36 04 032	B	1,5	20	2.400	50725	8,87
32 x 20	16	36 04 033	B	1,7	20	2.400	50726	8,87
40 x 32	16	36 04 040	B	2,3	15	1.800	50727	12,24
50 x 40	16	36 04 050	C	5,9	20	1.200	50728	15,95
63 x 50	16	36 04 063	C	5,5	10	600	50729	27,30
63 x 25	16	36 04 066	C	6,5	12	720	50730	29,23
75 x 40	16	36 04 077	C	4,8	6	360	50731	61,23
90 x 50	16	36 04 092	C	4,5	3	180	50732	106,79
110 x 63	16	36 04 112	C	4,9	2	120	50733	149,51

CP. 05. SF

C19 | ACC 010

MANICOTTO
 incollaggio

SOCKET
 solvent socket

SIZE	PN	REF.	PACK	kg	Q(B)	Q(P)	CODE	EUR
16	16	36 05 016	B	0,8	100	12.000	50734	2,88
20	16	36 05 020	B	1,4	100	12.000	50735	3,09
25	16	36 05 025	B	1,5	60	7.200	50736	3,63
32	16	36 05 032	B	1,6	40	4.800	50737	4,42
40	16	36 05 040	B	2,8	40	4.800	50738	6,35
50	16	36 05 050	B	2,6	21	2.520	50739	7,89
63	16	36 05 063	B	2,3	10	1.200	50740	10,63
75	16	36 05 075	B	1,6	6	720	50741	24,15
90	16	36 05 090	C	4,0	8	480	50742	40,23
110	16	36 05 110	C	4,0	5	300	50743	76,60

CP. 06. SMF

C19 | ACC 010

BUSSOLA RIDUZIONE
 incollaggio

REDUCING BUSH
 solvent socket

SIZE	PN	REF.	PACK	kg	Q(B)	Q(P)	CODE	EUR
20 x 16	16	36 06 020	B	0,4	100	12.000	50744	2,80
25 x 20	16	36 06 025	B	0,8	100	12.000	50745	3,16
25 x 16	16	36 06 026	B	1,1	100	12.000	50746	3,16
32 x 25	16	36 06 032	B	1,5	100	12.000	50747	3,85
32 x 20	16	36 06 033	B	1,7	100	12.000	50748	3,85
40 x 32	16	36 06 040	B	1,6	60	3.600	50749	6,12
40 x 25	16	36 06 041	B	2,0	60	3.600	50750	6,12
50 x 40	16	36 06 050	B	1,8	40	4.800	50751	6,42
50 x 32	16	36 06 051	B	2,3	40	4.800	50752	6,42
63 x 50	16	36 06 063	B	3,2	36	4.320	50753	10,26
63 x 40	16	36 06 064	B	4,2	36	4.320	50754	10,26
75 x 63	16	36 06 075	B	2,2	24	2.880	50755	15,76
75 x 50	16	36 06 076	B	3,4	24	2.880	50756	15,76
90 x 75	16	36 06 090	B	2,7	18	2.160	50757	22,79
90 x 63	16	36 06 091	B	3,4	18	2.160	50758	22,79
110 x 90	16	36 06 110	B	1,8	6	720	50759	34,63
110 x 75	16	36 06 111	B	1,9	6	720	50760	34,63

CP. 15. SFMT

C19 | ACC 030

MANICOTTO NIPPOLO
 incollaggio e filetto maschio

ADAPTOR NIPPLE
 solvent socket x BSP male thread

SIZE	PN	REF.	PACK	kg	Q(B)	Q(P)	CODE	EUR
32-25 x 3/4"	16	36 15 433	B	2,3	60	7.200	50776	5,48
32-20 x 3/4"	16	36 15 436	B	2,7	60	7.200	50777	5,76
32-20 x 1/2"	16	36 15 437	B	2,4	60	7.200	50778	5,76
32-16 x 1/2"	16	36 15 439	B	2,6	60	7.200	50779	5,76
40-32 x 1"	16	36 15 441	B	2,4	40	4.800	50780	6,67
40-25 x 1"	16	36 15 444	B	3,6	50	6.000	50781	7,81
50-40 x 1"1/4	16	36 15 451	B	3,1	30	3.600	50782	8,31
50-32 x 1"1/4	16	36 15 454	B	4,5	36	4.320	50783	9,74
63-50 x 1"1/2	16	36 15 464	B	4,5	24	2.880	50784	13,14
63-40 x 1"1/2	16	36 15 467	B	4,86	24	2.880	50785	15,75
75-63 x 2"	16	36 15 476	B	3,1	16	1.920	50786	22,55
75-50 x 2"	16	36 15 479	B	2,9	12	1.440	50787	25,11

CP. 10. SF

C19 | ACC 010



COLLARE
incollaggio

FLANGE ADAPTOR (STUB FLANGE)
solvent socket

SIZE	PN	REF.	PACK	kg	Q(B)	Q(P)	CODE	EUR
20	16	36 10 020	B	2,0	200	24.000	56810	4,20
25	16	36 10 025	B	2,6	160	19.200	56811	4,99
32	16	36 10 032	B	1,9	80	9.600	56812	5,43
40	16	36 10 040	B	1,9	40	4.800	50770	7,20
50	16	36 10 050	B	2,8	40	4.800	50771	8,98
63	16	36 10 063	B	2,1	18	2.160	50772	16,55
75	16	36 10 075	B	2,2	12	1.440	50773	26,78
90	16	36 10 090	C	4,4	15	900	50774	37,09
110	16	36 10 110	C	4,6	10	600	50775	47,80

CP. 11. FLG

C19 | ACC 010



FLANGIA

FLANGE (BACKING RING)

SIZE	PN	REF.	PACK	kg	Q(B)	Q(P)	CODE	EUR
20		36 11 020	B	3,6	40	4.800	56245	8,76
25		36 11 025	B	3,5	30	3.600	56246	10,04
32		36 11 032	B	3,2	20	2.400	56247	11,17
40		36 11 040	B	5,3	22	2.640	56248	13,37
50		36 11 050	B	4,8	18	2.160	56249	19,30
63		36 11 063	C	6,8	20	1.200	56250	33,51
75		36 11 075	C	6,6	15	900	57714	42,07
90		36 11 090	D	17,8	34	1.020	57715	51,72
110		36 11 110	D	13,8	22	660	57716	64,07

CP. 07. SF

C19 | ACC 010



CALOTTA
incollaggio

CAP
solvent socket

SIZE	PN	REF.	PACK	kg	Q(B)	Q(P)	CODE	EUR
16	16	36 07 016	B	0,6	100	12.000	50761	2,28
20	16	36 07 020	B	1,1	100	12.000	50762	2,28
25	16	36 07 025	B	2,4	100	12.000	50763	3,47
32	16	36 07 032	B	1,9	60	7.200	50764	6,51
40	16	36 07 040	B	2,2	40	4.800	50765	7,89
50	16	36 07 050	B	3,4	36	4.320	50766	10,84
63	16	36 07 063	B	3,6	20	2.400	50767	12,70
75	16	36 07 075	B	3,0	16	1.920	50768	23,06
90	16	36 07 090	B	2,4	8	960	50769	31,34
110	16	36 07 110	C	6,4	12	720	50800	47,50

CP. 50. SF

C19 | ACC 050

BOCCHETTONE

incollaggio

UNION

solvent socket

SIZE	PN	REF.	PACK	kg	Q(B)	Q(P)	CODE	EUR
20	16	36 50 020	B	3,1	80	9.600	69610	12,87
25	16	36 50 025	B	2,6	40	4.800	69611	13,96
32	16	36 50 032	B	2,8	30	3.600	69612	16,74
40	16	36 50 040	C	6,4	40	2.400	69613	22,72
50	16	36 50 050	C	5,5	30	1.800	69614	31,64
63	16	36 50 063	C	4,1	12	720	69615	44,68
75	10	36 50 075	-	0,7	2	-	39303	Consultare
90	10	36 50 090	-	1,0	2	-	39304	Consultare
110	10	36 50 110	-	1,5	1	-	39305	Consultare

CP-E. 510. STF

C19 | COM 120

BOCCHETTONE MISTO

incollaggio e filetto femmina

UNION

female solvent socket x BSP thread

SIZE	PN	REF.	PACK	kg	Q(B)	Q(P)	CODE	EUR
20 x 1/2"	16	36 50 420	B	3,2	80	9600	70881	Consultare
25 x 3/4"	16	36 50 425	B	2,9	40	4800	70882	Consultare
32 x 1"	16	36 50 432	B	3,0	30	3600	70883	Consultare
40 x 1 1/4"	16	36 50 440	C	7,0	40	2400	70884	Consultare
50 x 1 1/2"	16	36 50 450	-	-	-	-	70885	Consultare
63 x 2"	16	36 50 463	-	-	-	-	70886	Consultare

CP. 100. SFTR

C19 | COM 120

GOMITO 90°

incollaggio e filetto femmina rinforzato

90° ELBOW

solvent socket x BSP female thread reinforced

SIZE	PN	REF.	PACK	kg	Q(B)	Q(P)	CODE	EUR
20 x 1/2"	16	-	-	0,0	-	-	39271	Consultare
25 x 3/4"	16	-	-	0,0	10	-	39272	Consultare
32 x 1"	16	-	-	0,1	40	-	39273	Consultare
40 x 1 1/4"	16	-	-	0,1	100	-	39274	Consultare
50 x 1 1/2"	16	-	-	0,2	300	-	39275	Consultare
63 x 2"	16	-	-	0,4	10	-	39276	Consultare

CP. 910. SFTR

C19 | COM 120

MANICOTTO

incollaggio e filetto femmina rinforzato

SOCKET

solvent socket x BSP female thread reinforced

SIZE	PN	REF.	PACK	kg	Q(B)	Q(P)	CODE	EUR
20 x 1/2"	16	-	-	0,0	10	-	39277	Consultare
25 x 3/4"	16	-	-	0,0	10	-	39278	Consultare
32 x 1"	16	-	-	0,1	10	-	39279	Consultare
40 x 1 1/4"	16	-	-	0,1	10	-	39280	Consultare
50 x 1 1/2"	16	-	-	0,1	10	-	39281	Consultare
63 x 2"	16	-	-	0,2	5	-	39282	Consultare

CP. 910. SMTFR

C19 | COM 120

BUSSOLA RIDUZIONE

incollaggio maschio e filetto femmina rinforza

REDUCING BUSH

male solvent socket x BSP reinforced female t

SIZE	PN	REF.	PACK	kg	Q(B)	Q(P)	CODE	EUR
20 x 1/2"	16	-	-	0,0	10	-	39283	Consultare
25 x 3/4"	16	-	-	0,0	10	-	39284	Consultare
32 x 1"	16	-	-	0,0	10	-	39285	Consultare
40 x 1 1/4"	16	-	-	0,1	10	-	39286	Consultare
50 x 1 1/2"	16	-	-	0,1	10	-	39287	Consultare
63 x 2"	16	-	-	0,2	5	-	39288	Consultare

ADESIVI PVC-C - CPVC SOLVENT CEMENT
CP. 90 SCH

C19 | ADH 010



ADESIVI PVC-C HT-120
con applicatore

HT-120 CPVC SOLVENT CEMENT
with brush

SIZE	PN	REF.	PACK	kg	Q(B)	Q(P)	CODE	EUR
500 cc c/pen.		05 90 101 UNI	-	7,0	12	924	52708	81,45

UP. 90. SCHCR

C19 | ADH 010



ADESIVI PVC-U/PVC-C HCR-36
alta resistenza chimica

HCR-36 PVC-U/CPVC SOLVENT CEM.
high chemical resistance

SIZE	PN	REF.	PACK	kg	Q(B)	Q(P)	CODE	EUR
1.000 cc		05 90 100 HCR	C	8,1	6	360	52711	206,50

TUBO PVC-C - CPVC RIGID PIPE

T02 | 007010



TUBO RIGIDO
PN16

RIGID PIPE
PN16

SIZE	THICKNESS	LENGTH	CODE	EUR/tubo
16	1,2	5	52686	Consultare
20	1,5	5	52687	Consultare
25	1,9	5	52688	Consultare
32	2,4	5	52689	Consultare
40	3,0	5	52690	Consultare
50	3,7	5	52691-IT	Consultare
63	4,7	5	52692	Consultare
75	5,6	5	52693	Consultare
90	6,7	5	52694	Consultare
110	8,1	5	52695	Consultare

Il prezzo è inteso a barra da 5 mt e non a mL.
The price is to consider for the 5mt bar, not mL.

VALVOLE PER ACQUA PVC-C

CPVC WATER VALVES

Accessori PVC-U

Valvole PVC-U

Accessori PVC-C

Valvole PVC-C

Valvole Extreme

Evacuazione

Ricambi

93

Valvole a sfera PVC-C CORZAN® [STD]
PVC-C ball valves CORZAN® [STD]



95

Valvole a sfera PVC-C CORZAN® [INDUSTRIAL]
PVC-C ball valves CORZAN® [INDUSTRIAL]



97

Valvole di ritegno in PVC-C CORZAN® serie molla
PVC-C CORZAN® CHECK VALVES spring series



98

Valvole di ritegno in PVC-C CORZAN® serie sfera
PVC-C CORZAN® CHECK VALVES ball series



99

Valvole a farfalla in PVC-C CORZAN®
PVC-C CORZAN® BUTTERFLY VALVES



DISTINTIVO MANIGLIA

● PTFE-EPDM

● PTFE-FPM

VALVOLE A SFERA IN PVC-C CORZAN® SERIE [STD] - PVC-C CORZAN® BALL VALVES [STD] SERIES

CP. 61ST. SF6

C03 | VAL 313



PTFE - EPDM perox.
incollaggio

PTFE - EPDM perox.
solvent socket



SIZE	PN	REF.	PACK	kg	Q(B)	Q(P)	CODE	EUR
16	16	36 61 016	B	3,2	24 (12)	2880	59006	63,95
20	16	36 61 020	B	3,2	24 (12)	2880	59007	63,95
25	16	36 61 025	B	1,43	10 (5)	1200	59008	70,07
32	16	36 61 032	B	1,746	8	960	59009	79,83
40	16	36 61 040	B	2,2	6	720	59011	90,64
50	16	36 61 050	C	4,696	10	600	59012	111,62
63	16	36 61 063	D	7,766	10	300	59013	135,31
75	10	36 61 075	D	9,316	4 (1)	120	59014	285,36
90	10	36 61 090	D	7,16	2 (1)	60	59015	398,51
110	10	36 61 111	D	8,32	1	30	59016	840,09

CP. 61ST. FT6

C03 | VAL 313



PTFE - EPDM perox.
filetto femmina

PTFE - EPDM perox.
BSP female thread



SIZE	PN	REF.	PACK	kg	Q(B)	Q(P)	CODE	EUR
3/8"	10	36 61 616	B	3,2	24 (12)	2880	59029	65,89
1/2"	10	36 61 620	B	3,2	24 (12)	2880	59030	65,89
3/4"	10	36 61 625	B	1,43	10 (5)	1200	59032	72,17
1"	10	36 61 632	B	1,746	8	960	59034	82,24
1 1/4"	10	36 61 640	B	2,2	6	720	59035	93,37
1 1/2"	10	36 61 650	C	4,696	10	600	59036	114,98
2"	10	36 61 663	D	7,766	10	300	59037	139,35
2 1/2"	10	36 61 675	D	9,2	4 (1)	120	59038	293,92
3"	10	36 61 690	D	7,16	2 (1)	60	59040	410,47
4"	10	36 61 711	D	8,32	1	30	59042	865,29

CP. 61ST. SF7

C03 | VAL 313



PTFE - FPM
incollaggio

PTFE - FPM
solvent socket



SIZE	PN	REF.	PACK	kg	Q(B)	Q(P)	CODE	EUR
16	16	36 61 016 VI	B	3,2	24 (12)	2880	59017	81,61
20	16	36 61 020 VI	B	3,2	24 (12)	2880	59018	81,61
25	16	36 61 025 VI	B	1,43	10 (5)	1200	59019	88,47
32	16	36 61 032 VI	B	1,746	8	960	59020	98,79
40	16	36 61 040 VI	B	2,2	6	720	59021	112,05
50	16	36 61 050 VI	C	4,696	10	600	59022	145,54
63	16	36 61 063 VI	D	7,766	10	300	59024	165,78
75	10	36 61 075 VI	D	9,2	4 (1)	120	59025	360,36
90	10	36 61 090 VI	D	7,16	2 (1)	60	59027	471,47
110	10	36 61 111 VI	D	8,32	1	30	59028	927,80

CP. 61ST. FT7

C03 | VAL 313



PTFE - FPM
filetto femmina

PTFE - FPM
BSP female thread



SIZE	PN	REF.	PACK	kg	Q(B)	Q(P)	CODE	EUR
3/8"	10	36 61 616 VI	B	3,2	24 (12)	2880	59044	84,06
1/2"	10	36 61 620 VI	B	3,2	24 (12)	2880	59045	84,06
3/4"	10	36 61 625 VI	B	1,43	10 (5)	1200	59046	91,16
1"	10	36 61 632 VI	B	1,746	8	960	59047	101,76
1 1/4"	10	36 61 640 VI	B	2,2	6	720	59048	115,42
1 1/2"	10	36 61 650 VI	C	4,696	10	600	59049	149,90
2"	10	36 61 663 VI	D	7,766	10	300	59050	170,74
2 1/2"	10	36 61 675 VI	D	9,2	4 (1)	120	59052	371,16
3"	10	36 61 690 VI	D	7,16	2 (1)	60	59055	485,59
4"	10	36 61 711 VI	D	8,32	1	30	59056	955,64

CONNESSIONI VALVOLE A SFERA SERIE STD - BALL VALVE END CONNECTORS STD SERIES
CP. 22ST. SF. VA

C03 | VAL 325

MANICOTTO VALVOLE A SFERA [STD]

incollaggio CPVC

[STD] BALL VALVE END CONNECTOR

CPVC female solvent socket

SIZE	PN	REF.	PACK	kg	Q(B)	Q(P)	CODE	EUR
16	16	36 22 016 VA	#N/A	#N/A	#N/A	#N/A	64457	1,38
20	16	36 22 020 VA	#N/A	#N/A	#N/A	#N/A	64458	1,38
25	16	36 22 025 VA	#N/A	#N/A	#N/A	#N/A	64459	1,79
32	16	36 22 032 VA	#N/A	#N/A	#N/A	#N/A	64460	3,45
40	16	36 22 040 VA	#N/A	#N/A	#N/A	#N/A	64461	4,99
50	16	36 22 050 VA	#N/A	#N/A	#N/A	#N/A	64462	6,74
63	16	36 22 063 VA	#N/A	#N/A	#N/A	#N/A	64463	12,24
75	10	36 22 075 VA	#N/A	#N/A	#N/A	#N/A	64464	17,19
90	10	36 22 090 VA	#N/A	#N/A	#N/A	#N/A	64465	30,75
110	10	36 22 111 VA	#N/A	#N/A	#N/A	#N/A	64466	64,18

CP. 22ST. FT. VA

C03 | VAL 325

MANICOTTO VALVOLE A SFERA [STD]

filetto femmina CPVC

[STD] BALL VALVE END CONNECTOR

CPVC female thread

SIZE	PN	REF.	PACK	kg	Q(B)	Q(P)	CODE	EUR
3/8"	16	36 22 616 VA	#N/A	#N/A	#N/A	#N/A	64469	2,21
1/2"	16	36 22 620 VA	#N/A	#N/A	#N/A	#N/A	64470	2,19
3/4"	16	36 22 625 VA	#N/A	#N/A	#N/A	#N/A	64471	2,76
1"	16	36 22 632 VA	#N/A	#N/A	#N/A	#N/A	64472	4,45
1"1/4	16	36 22 640 VA	#N/A	#N/A	#N/A	#N/A	64473	6,04
1"1/2	16	36 22 650 VA	#N/A	#N/A	#N/A	#N/A	64474	9,43
2"	16	36 22 663 VA	#N/A	#N/A	#N/A	#N/A	64475	15,32
2"1/2	10	36 22 675 VA	#N/A	#N/A	#N/A	#N/A	64476	26,69
3"	10	36 22 690 VA	#N/A	#N/A	#N/A	#N/A	64477	37,18
4"	10	36 22 711 VA	#N/A	#N/A	#N/A	#N/A	64478	90,34

CP. 22ST. SM. VA

C03 | VAL 325

MANICOTTO VALVOLE A SFERA [STD]

incollaggio maschio CPVC

[STD] BALL VALVE END CONNECTOR

CPVC male solvent socket

SIZE	PN	REF.	PACK	kg	Q(B)	Q(P)	CODE	EUR
20	16	36 22 220 VA	C	3,6	200 (25)	12000	66859	3,08
25	16	36 22 225 VA	C	3,6	200 (25)	12000	66860	3,34
32	16	36 22 232 VA	C	3,6	200 (25)	12000	66861	4,00
40	16	36 22 240 VA	C	3,6	200 (25)	12000	66862	5,31
50	16	36 22 250 VA	C	3,6	200 (25)	12000	66863	7,76
63	16	36 22 263 VA	C	3,6	200 (25)	12000	66864	13,30
75	10	36 22 275 VA	C	2,6	20 (10)	1200	68537	20,70
90	10	36 22 290 VA	C	2,6	20 (10)	1200	68538	31,10
110	10	36 22 311 VA	-	-	-	-	33806	61,21

Conneessioni compatibili con le valvole a sfera Cepex Serie STD (pag. 93). Non compatibili con il modello della valvola Standard o Industrial.
 End connectors compatible with the Cepex STD Series (pag. 93). Not compatible with the valve model Standard or Industrial.

VALVOLE A SFERA IN PVC-C CORZAN® SERIE INDUSTRIAL - PVC-C CORZAN® BALL VALVES INDUSTRIAL SERIES

CP. 73. SF6

C03 | VAL 320



PTFE - EPDM perox.
incollaggio

PTFE - EPDM perox.
solvent socket



SIZE	PN	REF.	PACK	kg	Q(B)	Q(P)	CODE	EUR
16	16	35 73 016	B	1,41	8 (1)	960	22804	38,81
20	16	35 73 020	B	1,38	8 (1)	960	22805	38,81
25	16	35 73 025	B	2,23	8 (1)	960	22806	47,73
32	16	35 73 032	B	1,67	4 (1)	480	22807	59,77
40	16	35 73 040	B	2,39	4 (1)	480	22808	83,18
50	16	35 73 050	D	7,86	8 (1)	240	22809	106,23
63	16	35 73 063	D	9,48	6 (1)	180	22810	141,28
75	10	35 73 075	D	9,916	4 (1)	120	22811	378,00
90	10	35 73 090	D	8,94	2 (1)	60	22812	456,27
110	10	35 73 111	D	8,73	1	30	26444	945,07

CP. 73. FT6

C03 | VAL 320



PTFE - EPDM perox.
filetto femmina

PTFE - EPDM perox.
BSP female thread



SIZE	PN	REF.	PACK	kg	Q(B)	Q(P)	CODE	EUR
3/8"	16	35 73 616	B	1,44	8 (1)	960	22814	40,65
1/2"	16	35 73 620	B	1,39	8 (1)	960	22815	40,65
3/4"	16	35 73 625	B	2,26	8 (1)	960	22816	50,01
1"	16	35 73 632	B	1,69	4 (1)	480	22817	63,16
1 1/4"	16	35 73 640	B	2,57	4 (1)	480	22818	89,71
1 1/2"	16	35 73 650	D	8,17	8 (1)	240	22819	112,01
2"	16	35 73 663	D	9,86	6 (1)	180	22820	146,40
2 1/2"	10	35 73 675	D	11,3	4 (1)	120	22821	389,69
3"	10	35 73 690	D	9,17	2 (1)	60	22822	467,47
4"	10	35 73 711	D	8,7	1	30	26445	995,23

CP. 73. SF7

C03 | VAL 320



PTFE - FPM
incollaggio

PTFE - FPM
solvent socket



SIZE	PN	REF.	PACK	kg	Q(B)	Q(P)	CODE	EUR
16	16	35 73 016 VI	B	1,39	8 (1)	960	22824	53,73
20	16	35 73 020 VI	B	1,41	8 (1)	960	22825	53,73
25	16	35 73 025 VI	B	2,26	8 (1)	960	22826	65,47
32	16	35 73 032 VI	B	1,67	4 (1)	480	22827	82,39
40	16	35 73 040 VI	B	2,56	4 (1)	480	22828	109,34
50	16	35 73 050 VI	D	8,07	8 (1)	240	22829	144,99
63	16	35 73 063 VI	D	9,71	6 (1)	180	22830	186,38
75	10	35 73 075 VI	D	11,3	4 (1)	120	22831	429,12
90	10	35 73 090 VI	D	8,97	2 (1)	60	22832	510,45
110	10	35 73 111 VI	D	9,14	1	30	26446	978,62

CP. 73. FT7

C03 | VAL 320



PTFE - FPM
filetto femmina

PTFE - FPM
BSP female thread



SIZE	PN	REF.	PACK	kg	Q(B)	Q(P)	CODE	EUR
3/8"	16	35 73 616 VI	C	3,06	16 (1)	960	22834	55,54
1/2"	16	35 73 620 VI	B	1,39	8 (1)	960	22835	55,54
3/4"	16	35 73 625 VI	B	2,21	8 (1)	960	22836	67,68
1"	16	35 73 632 VI	B	1,7	4 (1)	480	22837	85,77
1 1/4"	16	35 73 640 VI	B	2,57	4 (1)	480	22838	113,84
1 1/2"	16	35 73 650 VI	D	7,488	8 (1)	240	22839	150,87
2"	16	35 73 663 VI	D	9,71	6 (1)	180	22840	194,12
2 1/2"	10	35 73 675 VI	D	11,3	4 (1)	120	22841	449,36
3"	10	35 73 690 VI	D	8,43	2 (1)	60	22842	531,90
4"	10	35 73 711 VI	D	8,8	1	30	26447	1.008,79

CONNESSIONI VALVOLE A SFERA SERIE INDUSTRIAL - BALL VALVE END CONNECTORS INDUSTRIAL SERIES

CP. 22. SM. VA

C03 | VAL 327



PEZZO FOLLE
incollaggio maschio CPVC

BALL VALVE END CONNECTOR
CPVC male solvent socket

SIZE	PN	REF.	PACK	kg	Q(B)	Q(P)	CODE	EUR
16	16	35 22 216 VA	C	3,6	200 (25)	12000	33797	3,05
20	16	35 22 220 VA	C	3,6	200 (25)	12000	33798	3,05
25	16	35 22 225 VA	C	4,32	160 (20)	9600	33799	3,29
32	16	35 22 232 VA	C	3,2	80 (20)	4800	33800	4,00
40	16	35 22 240 VA	C	3,78	60 (15)	3600	33801	5,31
50	16	35 22 250 VA	C	3,76	40 (20)	2400	33802	7,66
63	16	35 22 263 VA	C	5,4	30 (15)	1800	33803	13,11
75	10	35 22 275 VA	C	2,6	20 (10)	1200	33804	20,71
90	10	35 22 290 VA	C	5,675	15	900	33805	31,08
110	10	35 22 311 VA	-	-	-	-	33806	61,21

CP. 22. MT. VA

C03 | VAL 327



PEZZO FOLLE
filetto maschio CPVC

BALL VALVE END CONNECTOR
CPVC BSP male thread

SIZE	PN	REF.	PACK	kg	Q(B)	Q(P)	CODE	EUR
3/8"	10	35 22 416 VA	C	3,6	1	60	32734	5,55
1/2"	10	35 22 420 VA	C	3,6	1	60	22077	5,55
3/4"	10	35 22 425 VA	C	4,32	160 (20)	9600	22311	6,11
1"	10	35 22 432 VA	C	3,2	80 (20)	4800	22312	7,06
1 1/4"	10	35 22 440 VA	C	3,78	60 (15)	3600	22313	8,52
1 1/2"	10	35 22 450 VA	C	3,76	40 (20)	2400	22314	9,94
2"	10	35 22 463 VA	C	5,4	30 (15)	1800	22315	16,80
2 1/2"	10	35 22 475 VA	C	5,235	16	960	22316	32,04
3"	10	35 22 490 VA	C	5,675	15	900	22317	43,83
4"	10	35 22 511 VA	C	4,68	5	300	22318	77,51

Conneessioni compatibili con le valvole a sfera Cepex Serie Industrial (pag. 95). Non compatibili con il nuovo modello della valvola [STD].
End connectors compatible with the Cepex Industrial Series (pag. 95) ball valves. Not compatible with the new valve model [STD].

Accessori PVC-U

Valvole PVC-U

Accessori PVC-C

Valvole PVC-C

Valvole Extreme

Evacuazione

Ricambi

VALVOLE DI RITEGNO IN PVC-C CORZAN® SERIE MOLLA - PVC-C CORZAN® CHECK VALVES SPRING SERIES

CP-S. 67. SF1

C03 | APC 420



O-ring in EPDM perox.
incollaggio

EPDM perox. O-rings
solvent socket

SIZE	PN	REF.	PACK	kg	Q(B)	Q(P)	CODE	EUR
16	16	35 67 016	B	3,44	24 (12)	2880	22844	23,66
20	16	35 67 020	B	3,246	24 (12)	2880	22845	23,66
25	16	35 67 025	B	2,78	12 (6)	1440	22846	29,21
32	16	35 67 032	B	3,34	10	1200	22847	33,05
40	16	35 67 040	B	3,16	6	720	22848	41,13
50	16	35 67 050	C	8	12	720	22849	57,84
63	16	35 67 063	D	11,7	10	300	22850	84,15
75	10	35 67 075	D	8,68	4 (1)	120	22851	185,64
90	10	35 67 090	D	7,47	2 (1)	60	22852	253,23
110 (DN80)	10	35 67 110	D	7,83	2 (1)	60	22853	272,92

CP-S. 67. FT1

C03 | APC 420



O-ring in EPDM perox.
filetto femmina

EPDM perox. O-rings
BSP female thread

SIZE	PN	REF.	PACK	kg	Q(B)	Q(P)	CODE	EUR
3/8"	16	35 67 616	B	3,24	24 (12)	2880	22854	24,55
1/2"	16	35 67 620	B	3,35	24 (12)	2880	22855	24,55
3/4"	16	35 67 625	B	2,786	12 (6)	1440	22856	30,27
1"	16	35 67 632	B	3,33	10	1200	22857	34,68
1 1/4"	16	35 67 640	B	3,19	6	720	22858	43,29
1 1/2"	16	35 67 650	C	8,29	12	720	22859	60,46
2"	16	35 67 663	D	12,1	10	300	22860	87,73
2 1/2"	10	35 67 675	D	8,73	4 (1)	120	22861	195,05
3"	10	35 67 690	D	7,71	2 (1)	60	22862	263,16
4" (DN80)	10	35 67 710	D	8,34	2 (1)	60	22863	283,80

CP-S. 67. SF4

C03 | APC 420



O-ring in FPM
incollaggio

FPM O-Rings
solvent socket

SIZE	PN	REF.	PACK	kg	Q(B)	Q(P)	CODE	EUR
16	16	35 67 016 VI	C	6,36	48	2880	22864	39,07
20	16	35 67 020 VI	B	3,408	24 (12)	2880	22865	39,07
25	16	35 67 025 VI	B	2,86	12 (6)	1440	22866	44,16
32	16	35 67 032 VI	B	3,38	10	1200	22867	47,60
40	16	35 67 040 VI	B	3,19	6	720	22868	63,39
50	16	35 67 050 VI	C	8,08	12	720	22869	92,31
63	16	35 67 063 VI	D	10,7	10	300	22870	122,70
75	10	35 67 075 VI	D	8,88	4 (1)	120	22871	233,20
90	10	35 67 090 VI	D	7,562	2 (1)	60	22872	304,35
110 (DN80)	10	35 67 110 VI	D	8,63	2 (1)	60	22873	323,07

CP-S. 67. FT4

C03 | APC 420



O-ring in FPM
filetto femmina

FPM O-Rings
BSP female thread

SIZE	PN	REF.	PACK	kg	Q(B)	Q(P)	CODE	EUR
3/8"	16	35 67 616 VI	C	6,4	48 (6)	2880	22874	39,95
1/2"	16	35 67 620 VI	B	3,12	24 (12)	2880	22875	39,95
3/4"	16	35 67 625 VI	B	2,77	12 (6)	1440	22876	45,19
1"	16	35 67 632 VI	B	3,362	10	1200	22877	52,47
1 1/4"	16	35 67 640 VI	B	3,214	6	720	22878	65,50
1 1/2"	16	35 67 650 VI	C	8,63	12	720	22879	94,90
2"	16	35 67 663 VI	D	11,5	12	360	22880	126,20
2 1/2"	10	35 67 675 VI	D	8,3	4 (1)	120	22881	242,62
3"	10	35 67 690 VI	D	7,58	2 (1)	60	22882	314,30
4" (DN80)	10	35 67 710 VI	D	8,63	2 (1)	60	22883	334,04

VALVOLE DI RITEGNO IN PVC-C CORZAN® SERIE SFERA - PVC-C CORZAN® CHECK VALVES BALL SERIES

CP-B. 67. SF1

C03 | APC 440

O-ring in EPDM perox.
incollaggio

EPDM perox. O-rings
solvent socket

SIZE	PN	REF.	PACK	kg	Q(B)	Q(P)	CODE	EUR
20	16	35 67 220	B	3,6	24 (12)	2880	27501	42,57
25	16	35 67 225	B	3,03	12 (6)	1440	27502	65,40
32	16	35 67 232	B	3,68	10	1200	27503	70,30
40	16	35 67 240	B	3,46	6	720	27504	96,52
50	16	35 67 250	C	8,67	12	720	27505	115,60
63	16	35 67 263	D	12,6	10	300	27506	184,52
75	10	35 67 275	D	10,3	4 (1)	120	27507	544,94
90	10	35 67 290	D	8,81	2 (1)	60	27508	885,20
110 (DN 80)	10	35 67 310	D	9,18	2 (1)	60	27509	912,20

CP-B. 67 FT1

C03 | APC 440

O-ring in EPDM perox.
filetto femmina

EPDM perox. O-rings
BSP female thread

SIZE	PN	REF.	PACK	kg	Q(B)	Q(P)	CODE	EUR
½"	16	35 67 420	B	3,6	24 (12)	2880	27510	43,19
¾"	16	35 67 425	B	3,03	12 (6)	1440	27511	66,05
1"	16	35 67 432	B	3,08	10	1200	27512	72,24
1¼"	16	35 67 440	B	3,48	6	720	27513	99,60
1½"	16	35 67 450	C	8,7	12	720	27514	119,12
2"	16	35 67 463	D	13,2	10	300	27515	186,76
2½"	10	35 67 475	D	8,2	4 (1)	120	27516	574,97
3"	10	35 67 490	D	8,92	2 (1)	60	27517	887,42
4" (DN 80)	10	35 67 510	D	9,21	2 (1)	60	27518	921,90

CP-B. 67. SF4

C03 | APC 440

O-ring in FPM
incollaggio

FPM O-Rings
solvent socket

SIZE	PN	REF.	PACK	kg	Q(B)	Q(P)	CODE	EUR
20	16	35 67 220 VI	B	3,6	24 (12)	2880	27519	67,07
25	16	35 67 225 VI	B	3,204	12 (6)	1440	27520	89,97
32	16	35 67 232 VI	B	3,652	10	1200	27521	98,64
40	16	35 67 240 VI	B	3,516	6	720	27522	133,46
50	16	35 67 250 VI	C	3,766	12	720	27523	170,05
63	16	35 67 263 VI	D	12,84	10	300	27524	250,64
75	10	35 67 275 VI	D	10,92	4 (1)	120	27525	613,87
90	10	35 67 290 VI	D	3,434	2 (1)	60	27526	958,62
110 (DN 80)	10	35 67 310 VI	D	3,226	2 (1)	60	27527	985,22

CP-B. 67. FT4

C03 | APC 440

O-ring in FPM
filetto femmina

FPM O-Rings
BSP female thread

SIZE	PN	REF.	PACK	kg	Q(B)	Q(P)	CODE	EUR
½"	16	35 67 420 VI	B	3,648	24 (12)	2880	27528	67,40
¾"	16	35 67 425 VI	B	2,96	12 (6)	1440	27529	90,44
1"	16	35 67 432 VI	B	3,696	10	1200	27530	97,71
1¼"	16	35 67 440 VI	B	3,558	6	720	27531	136,15
1½"	16	35 67 450 VI	C	3,132	12	720	27532	172,47
2"	16	35 67 463 VI	D	13,76	10	300	27533	252,51
2½"	10	35 67 475 VI	D	8,2	4 (1)	120	27534	641,97
3"	10	35 67 490 VI	D	3,191	2 (1)	60	27535	961,66
4" (DN 80)	10	35 67 510 VI	D	7,33	1 (1)	30	27536	996,39

Accessori PVC-U

Valvole PVC-U

Accessori PVC-C

Valvole PVC-C

Valvole Extreme

Evacuazione

Ricambi

VALVOLE A FARFALLA (LENTE IN CPVC) SERIE INDUSTRIAL - CPVC BUTTERFLY VALVES INDUSTRIAL SERIES

CP. 84. SS. FGEP

C03 | VMA 511



O-ring in EPDM perox.
perno in acciaio inox

EPDM perox. O-rings
stainless steel shaft

SIZE	PN	REF.	PACK	kg	Q(B)	Q(P)	CODE	EUR
63-75	10	35 84 075	V	2,46	2	168	34480	392,19
90	10	35 84 090	VII	3,23	2	112	34481	450,83
110	10	35 84 110	VII	4,38	2	112	33961	516,70
125-140	10	35 84 140	VIII	6,28	2	48	34482	677,88
160	10	35 84 160	IX	7,91	2	48	34483	838,92
200-225	10	35 84 200	VII	6,88	1	36	34484	1.289,75

CP. 84. SS. VI

C03 | VMA 511



O-ring in FPM
perno in acciaio inox

FPM O-Rings
stainless steel shaft

SIZE	PN	REF.	PACK	kg	Q(B)	Q(P)	CODE	EUR
63-75	10	35 84 075 VI	V	2,56	2	168	34485	513,32
90	10	35 84 090 VI	VII	3,22	2	112	34486	629,95
110	10	35 84 110 VI	VII	4,38	2	112	33962	816,16
125-140	10	35 84 140 VI	VIII	6,28	2	48	34487	1.072,87
160	10	35 84 160 VI	IX	8,2	2	48	34488	1.328,20
200-225	10	35 84 200 VI	VII	7,12	1	36	34489	2.108,84

CP. 84. SS. SGEP. RM

C03 | VMA 550



O-ring in EPDM perox.
perno in acciaio inox

EPDM perox. O-rings
stainless steel shaft

SIZE	PN	REF.	PACK	kg	Q(B)	Q(P)	CODE	EUR
63-75	10	35 84 075 RM	C	2,73	1	60	34490	727,88
90	10	35 84 090 RM	C	3,09	1	60	34491	744,34
110	10	35 84 110 RM	C	3,67	1	60	34492	818,92
125-140	10	35 84 140 RM	D	4,34	1	30	34493	928,79
160	10	35 84 160 RM	E	7,35	1	15	34494	1.289,98
200-225	10	35 84 200 RM	E	8,4	1	15	34495	1.813,65
250-280	6	35 84 250 RM	F	18,2	1	10	34496	3.027,95
315	6	35 84 315 RM	G	21,64	1	10	34497	3.924,48

CP. 84. SS. VI. RM

C03 | VMA 550



O-ring in FPM
perno in acciaio inox

FPM O-Rings
stainless steel shaft

SIZE	PN	REF.	PACK	kg	Q(B)	Q(P)	CODE	EUR
63-75	10	35 84 075 VRM	C	2,66	1	0	34498	820,40
90	10	35 84 090 VRM	C	3,09	1	0	34499	873,18
110	10	35 84 110 VRM	C	3,67	1	0	34500	1.008,87
125-140	10	35 84 140 VRM	D	3,83	1	0	34501	1.175,04
160	10	35 84 160 VRM	D	5,24	1	0	34502	1.607,52
200-225	10	35 84 200 VRM	E	11,8	1	15	34503	2.419,20
250-280	6	35 84 250 VRM	F	18,3	1	10	34504	4.041,91
315	6	35 84 315 VRM	G	22,5	1	10	34505	4.890,96

VALVOLE INDUSTRIALI MANUALI CEPEX EXTREME

CEPEX EXTREME INDUSTRIAL MANUAL VALVE

VALVOLE A SFERA MANUALI
MANUAL BALL VALVES

VALVOLE A MEMBRANA MANUALI
MANUAL DIAPHRAGM VALVES

VALVOLE A FARFALLA MANUALI
MANUAL BUTTERFLY VALVES

Accessori PVC-U

106 Valvole a sfera PVC-U
PVC-U ball valves



118 Valvole a membrana PVC-U
PVC-U diaphragm valves



125 Valvole a farfalla PVC-U
PVC-U butterfly valves



Valvole PVC-U

109 Valvole a sfera PVC-C
CPVC ball valves



120 Valvole a membrana PVC-C
CPVC diaphragm valves



127 Valvole a farfalla PVC-C
CPVC butterfly valves



Accessori PVC-C

111 Valvole a sfera PP-H
PP-H ball valves



122 Valvole a membrana PP-H
PP-H diaphragm valves



129 Valvole a farfalla PP-H
PP-H butterfly valves



Valvole PVC-C

114 Valvole a sfera PVDF
PVDF ball valves



131 Valvole a farfalla PVDF
PVDF butterfly valves



Valvole Extreme

116 Valvole a sfera ABS
ABS ball valves



133 Valvole a farfalla ABS
ABS butterfly valves



Evacuazione

ACCESSORI VALVOLE MANUALI
MANUAL VALVES ACCESSORIES

LEGENDA MATERIALI
MATERIALS LEGEND

Ricambi

135 Accessori
Accessories



	PVC-U
	PVC-C
	PP-H
	PVDF
	ABS

LA GAMMA CEPEX EXTREME

CEPEX EXTREME RANGE

VALVOLE A SFERA BALL VALVE



Sistema "Antiblock"
Porta O-ring filettato
 "Anti-block" system
 Threaded seal-carrier



**Impugnatura ergonomica e
superficie antiscivolo**
 Ergonomic handle with rubber anti-
slipping surface



**Rinforzo in acciaio inossidabile in
tutti i raccordi filettati femmina**
 SS reinforcement in all female threaded
unions

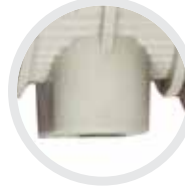

**Inseri filettati (INOX) per
montaggio a parete e
accoppiamento attuatore**
 Threaded inserts (SS) for wall-mounting
and actuator installation



Sfera meccanizzata e lucidata
 Machined and polished ball



**Perno meccanizzato
Doppio O-ring sul perno**
 Machined shaft
 Double shaft O-ring

VALVOLE A MEMBRANA DIAPHRAGM VALVE



Corpo prodotto in PP + GR
 Body made in PP + GR

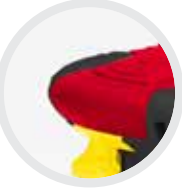

Sistema di blocco integrato
 Incorporated locking device



Volantino robusto ed ergonomico
 Strong and ergonomic handwheel



**Inseri filettati per montaggio a
parete**
 Threaded inserts for wall mounting



Viti nascoste
 Hidden bolts



Indicatore visivo di posizione
 Visual position indicator

VALVOLE A FARFALLA BUTTERFLY VALVE

Forza di azionamento
Operation force



**Evita la lieve rotazione eccentrica
dello stelo causata dalla forza di
azionamento.**

Avoid the slight eccentric stem rotation
caused by operation force.

Pressione differenziale
Differential pressure



**Nuova lavorazione e nuova
configurazione**
**Adattamento perfetto - riduzione
delle fughe.**

New machined and new setting
Perfect adaptation - Leakage reduction



**Nuovo disegno della maniglia
- doppia molla AISI-302, nuovi
materiali per una maggiore
durata**

New handle design - double spring AISI
302, new materials for more durability



**Ridotte interferenze e nuove
tolleranze nelle componenti
interne (perno - O-ring - corpo)**

New settings and tolerance (shaft -
O-rings - body) - leakage reduction

Accessori PVC-U

Valvole PVC-U

Accessori PVC-C

Valvole PVC-C

Valvole Extreme

Evacuazione

Ricambi

QUALITÀ - QUALITY

TEST DELLE VALVOLE

ASSEMBLATO (SECONDO GLI STANDARD EUROPEI)

- Pressione
- Resistenza agli agenti atmosferici
- Imballaggio
- Tracciabilità

TEST DI TENUTA

- Applicato al 100% della produzione di valvole Cepex.
- L'aria viene iniettata nella valvola attraverso un microfugometro.
- La valvola supera il test se non ci sono perdite d'aria.
- Il 100% delle valvole della serie Extreme vengono sottoposte a svariati test per la conduzione dei fluidi:

- 1,1xPN bar acqua chiusa.
- 1,5xPN bar acqua aperta.
- 0,5 bar aria pressione.

TESTS ON ASSEMBLED VALVES

(ACCORDING TO EUROPEAN STANDARDS)

- Pressure
- Watertightness
- Packaging
- Traceability

WATERTIGHTNESS TEST

- Applied to 100% of Cepex valves production.
- Air is injected inside the valve through a microfugometer.
- The valve passes the test if no air-leaks happen.
- Water test applied to 100% of the Serie Extreme valves (exclusively):

- 1,1xPN bar water closed.
- 1,5xPN bar water open.
- 0,5 bar pressure air.



Marcatura CE in tutte le valvole (certificata da laboratori esterni)

CE marking in all the valves
(by external labs)



Tracciabilità al 100% Marcatura laser delle caratteristiche della valvola

100% traceability
Laser marking of the valve characteristics

VALVOLE A SFERA - SERIE EXTREME

BALL VALVES - EXTREME SERIES



Dimensioni Sizes	Incollaggio D16 - D110 (DN10-DN100) Filetto 3/8" - 4" (DN10-DN100) Solvent cement D16 - D110 (DN10-DN100) Threaded 3/8" - 4" (DN10-DN100)	
Manicotti: standard normativi Standard end connections	Incollaggio - Metrico ASTM, British standard Filetto - BSP, NPT Flange - DIN, ANSI Saldatura testa a testa - SDR11 Solvent socket - Metric, ASTM, British standard Threaded - BSP, NPT Flanges - DIN, ANSI Butt welding - SDR11	EN ISO 1452, EN ISO 15493, BS 4346-1, ASTM D 2467 ISO 228-1, ASTM D 2464 EN558 Serie 1 DIN 3202-1, ANSI ASME B16.5
Pressione di lavoro Working pressure	PVC-U @ 20°C (73°F) D16 - D63 (3/8" - 2"): PN 16 (240 psi) PVC-C D75 - D110 (2 1/2" - 4"): PN 10 (150 psi) PVDF	PP-H @ 20°C (73°F) D16 - D63 (3/8" - 2"): PN 10 (240 psi) ABS D75 - D110 (2 1/2" - 4"): PN 6 (150 psi)
Materiali Materials	Corpo/Body: PVC-U / PVC-C / PP-H / PVDF / ABS	Guarnizione sagomata a sfera/Ball seats: PTFE O-rings: EPDM / FPM
Caratteristiche Characteristics	<ul style="list-style-type: none"> • Porta-guarnizioni filettato che ne permette la manutenzione senza svuotamento della linea. • Dispositivo esterno per la regolazione del porta o-ring filettato. • Sistema "Antiblock" che evita il blocco della sfera. • Testate al 100% in fabbrica con aria e acqua. • Minime perdite di carico. • Ridotta coppia di manovra. • Resistente a molti composti chimici inorganici. • Eccellenti caratteristiche di conduzione. • Attuazione pneumatica ed elettrica disponibile. 	<ul style="list-style-type: none"> • Threaded seal-carrier for upstream maintenance without emptying the system. • Tool for easy adjustment of the threaded seal-carrier (and ball torque). • "Antiblock" system that avoids ball blockage. • 100% factory tested (with air and water). • Minimal pressure drop. • Low operating torque. • Resistance to many inorganic chemicals. • Excellent flow characteristics. • Available with electric and pneumatic actuators.
Certificazioni Certifications	Valvola a sfera con certificazione - EN ISO 16135 Ball valve design regulation - EN ISO 16135 Certificato/Certificate - ACS (Attestation de Conformité Sanitaire)	



PVC-U

VALVOLE A SFERA PVC-U SERIE EXTREME - PVC-U BALL VALVE EXTREME SERIES

C08 | FAM VAL520

Accessori PVC-U

Valvole PVC-U

Accessori PVC-C

Valvole PVC-C

Valvole Extreme

Evacuazione

Ricambi:

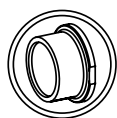
VALVOLE A SFERA PVC-U
 incollaggio femmina ISO/DIN

PVC-U BALL VALVE
 ISO/DIN metric solvent socket

DN	PN	D	EPDM	€	FPM	€
10	16	16	64583	43,26	64668	55,14
15	16	20	64584	43,26	64669	55,14
20	16	25	64585	50,74	64670	64,65
25	16	32	64586	63,23	64671	82,24
32	16	40	64587	78,43	64672	102,20
40	16	50	64588	96,50	64673	125,02
50	16	63	64589	116,47	64674	161,62
65	10	75	64590	267,62	64675	341,31
80	10	90	64591	310,16	64676	400,48
100	10	110	64592	417,66	64677	515,52

C08 | FAM VAL520

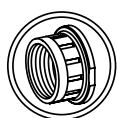
VALVOLE A SFERA PVC-U
 filetto femmina BSP
 rinforzo in acciaio inossidabile

PVC-U BALL VALVE
 female thread BSP
 Stainless steel reinforcement

DN	PN	G	EPDM	€	FPM	€
10	16	3/8"	64602	51,22	64678	63,10
15	16	1/2"	64603	51,22	64679	63,10
20	16	3/4"	64604	59,06	64680	72,97
25	16	1"	64605	73,20	64681	92,21
32	16	1 1/4"	64606	90,08	64682	113,85
40	16	1 1/2"	64607	111,12	64683	139,63
50	16	2"	64608	133,33	64684	178,49
65	10	2 1/2"	64609	288,30	64685	361,98
80	10	3"	64610	333,58	64686	423,90
100	10	4"	64611	450,37	64687	548,24

C08 | FAM VAL520

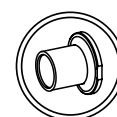

VALVOLE A SFERA PVC-U
 incollaggio maschio ISO/DIN

PVC-U BALL VALVE
 ISO/DIN metric male solvent socket

DN	PN	D	EPDM	€	FPM	€
10	16	16	66868	47,66	67413	59,54
15	16	20	66869	47,66	67414	59,54
20	16	25	66870	55,97	67415	69,88
25	16	32	66871	71,41	67416	90,44
32	16	40	66872	86,75	67417	110,52
40	16	50	66873	107,55	67418	136,07
50	16	63	66874	126,68	67419	171,84
65	10	75	67428	288,89	67430	362,57
80	10	90	67429	339,16	67431	429,48
100	10	110	68554	457,92	68555	555,78

VALVOLE A SFERA PVC-U SERIE EXTREME - PVC-U BALL VALVE EXTREME SERIES

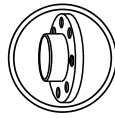
C08 | FAM VAL520

VALVOLE A SFERA PVC-U
 flangia ISO in PVC-U
 flangia libera (RF)

PVC-U BALL VALVE
 PVC-U ISO flanges
 loose flange (RF)

DN	PN	D	EPDM	€	FPM	€
15	16	20	64613	55,85	65031	67,74
20	16	25	64614	64,77	65032	78,67
25	16	32	64615	78,90	65033	97,93
32	16	40	64616	95,78	65034	119,55
40	16	50	64617	121,21	65035	149,74
50	16	63	64618	146,17	65036	191,09
65	10	75	64619	315,63	65037	389,32
80	10	90	64620	363,89	65038	454,20
100	10	110	64632	473,60	65039	571,47

C08 | FAM VAL520

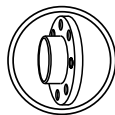
VALVOLE A SFERA PVC-U
 flangia ISO in PVC-U
 flangia fissa (FF)

PVC-U BALL VALVE
 PVC-U ISO flanges
 fixed flange (FF)

DN	PN	D	EPDM	€	FPM	€
15	16	20	72208	Consultare	72214	Consultare
20	16	25	72209	Consultare	72215	Consultare
25	16	32	72210	93,39	72216	Consultare
32	16	40	72211	Consultare	72217	Consultare
40	16	50	72212	Consultare	72218	Consultare
50	16	63	72213	179,04	72219	Consultare
65	10	75	72228	Consultare	72231	Consultare
80	10	90	72229	Consultare	72232	Consultare
100	10	110	72230	Consultare	72233	Consultare

C08 | FAM VAL520

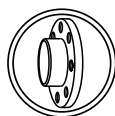
VALVOLE A SFERA PVC-U
 flangia ANSI-150 in PVC-U
 flangia fissa (FF)

PVC-U BALL VALVE
 PVC-U ANSI-150 flanges
 fixed flange (FF)

DN	PN	D	EPDM	€	FPM	€
15	16	½"	72208AB	78,53	72214AB	92,30
20	16	¾"	72209AB	90,13	72215AB	106,25
25	16	1"	72210AB	96,01	72216AB	119,16
32	16	1¼"	72211AB	116,55	72217AB	145,47
40	16	1½"	72212AB	147,49	72218AB	182,19
50	16	2"	72213AB	177,86	72219AB	232,51
65	10	2½"	72228AB	384,05	72231AB	473,70
80	10	3"	72229AB	442,76	72232AB	552,66
100	10	4"	72230AB	598,27	72233AB	695,34

PVC-U

VALVOLE A SFERA PVC-U SERIE EXTREME - PVC-U BALL VALVE EXTREME SERIES

C08 | FAM VAL520

Accessori PVC-U

Valvole PVC-U

Accessori PVC-C

Valvole PVC-C

Valvole Extreme

Evacuazione

Ricambi

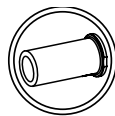

VALVOLE A SFERA PVC-U
PE100 / SDR11

PVC-U BALL VALVE
PE100 / SDR11



DN	PN	D	EPDM	€	FPM	€
15	16	20	64659	47,66	65134	59,54
20	16	25	64660	55,97	65135	69,88
25	16	32	64661	71,42	65136	90,44
32	16	40	64662	86,75	65138	110,52
40	16	50	64663	107,55	65141	136,07
50	16	63	64664	126,68	65142	171,84
65	10	75	64665	288,89	65143	362,58
80	10	90	64666	339,16	65144	429,48
100	10	110	64667	457,95	65145	555,78

PVC-C

VALVOLE A SFERA PVC-C SERIE EXTREME- CPVC BALL VALVE EXTREME SERIES

C08 | FAM VAL521

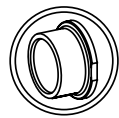
VALVOLE A SFERA PVC-C
 incollaggio femmina ISO/DIN

CPVC BALL VALVE
 solvent socket ISO/DIN

DN	PN	D	EPDM	€	FPM	€
10	16	16	64864	57,51	64875	69,40
15	16	20	64865	57,51	64876	69,40
20	16	25	64866	67,38	64877	81,64
25	16	32	64867	84,62	64878	103,63
32	16	40	64868	104,58	64879	128,35
40	16	50	64869	132,14	64880	160,67
50	16	63	64870	166,37	64881	211,53
65	10	75	64871	350,81	64882	424,49
80	10	90	64872	440,89	64883	531,20
100	10	110	64873	621,43	64884	719,29

C08 | FAM VAL521

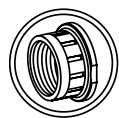
VALVOLE A SFERA PVC-C
 filetto femmina BSP
 rinforzo in acciaio inossidabile

CPVC BALL VALVE
 female thread BSP
 Stainless steel reinforcement

DN	PN	G	EPDM	€	FPM	€
10	16	3/8"	65146	65,48	65156	77,36
15	16	1/2"	65147	65,48	65157	77,36
20	16	3/4"	65148	75,70	65158	89,96
25	16	1"	65149	94,59	65159	113,60
32	16	1 1/4"	65150	116,22	65160	139,99
40	16	1 1/2"	65151	146,76	65161	175,29
50	16	2"	65152	183,25	65162	228,41
65	10	2 1/2"	65153	371,48	65163	445,17
80	10	3"	65154	464,30	65164	554,62
100	10	4"	65155	639,15	65165	737,02

C08 | FAM VAL521

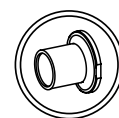
VALVOLE A SFERA PVC-C
 incollaggio maschio ISO/DIN

CPVC BALL VALVE
 metric male solvent socket ISO/DIN

DN	PN	D	EPDM	€	FPM	€
10	16	16	67420	60,38	67421	72,26
15	16	20	66875	60,38	67422	72,26
20	16	25	66876	70,82	67423	85,78
25	16	32	66877	88,89	67424	107,91
32	16	40	66878	109,81	67425	133,58
40	16	50	66879	138,81	67426	167,33
50	16	63	66880	174,69	67427	219,85
65	10	75	67432	368,35	67434	445,72
80	10	90	67433	462,93	67435	557,77
100	10	110	68556	652,50	68557	750,37

PVC-C

VALVOLE A SFERA PVC-C SERIE EXTREME - CPVC BALL VALVE EXTREME SERIES

C08 | FAM VAL521

Accessori PVC-U

Valvole PVC-U

Accessori PVC-C

Valvole PVC-C

Valvole Extreme

Evacuazione

Ricambi

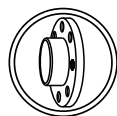

VALVOLE A SFERA PVC-C

flangia ISO in PVC-C
flangia libera (RF)

CPVC BALL VALVE

CPVC ISO flanges
loose flange (RF)

DN	PN	D	EPDM	€	FPM	€
15	16	20	64901	86,04	64851	97,93
20	16	25	64902	101,37	64852	115,63
25	16	32	64903	126,68	64853	145,70
32	16	40	64904	154,02	64854	177,78
40	16	50	64905	190,61	64855	219,14
50	16	63	64906	243,62	64856	288,77
65	10	75	64907	464,90	64857	538,57
80	10	90	64908	570,89	64858	661,21
100	10	110	64909	995,34	64859	1.093,20

C08 | FAM VAL521

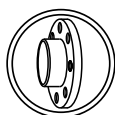

VALVOLE A SFERA PVC-C

flangia ANSI-150 in PVC-C
flangia fissa (FF)

CPVC BALL VALVE

CPVC ANSI-150 flanges
fixed flange (FF)

DN	PN	D	EPDM	€	FPM	€
15	16	½"	72235AB	112,95	72241AB	127,28
20	16	¾"	72236AB	133,38	72242AB	149,91
25	16	1"	72237AB	164,52	72243AB	186,54
32	16	1¼"	72238AB	194,80	72244AB	222,34
40	16	1½"	72239AB	241,11	72245AB	274,16
50	16	2"	72240AB	321,36	72246AB	373,69
65	10	2½"	72247AB	628,47	72250AB	776,98
80	10	3"	72248AB	687,92	72251AB	790,53
100	10	4"	72249AB	1.258,38	72252AB	1.378,00

PP-H

VALVOLE A SFERA PP-H SERIE EXTREME - PP-H BALL VALVE EXTREME SERIES

C08 | FAM VAL522

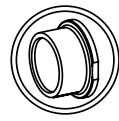
VALVOLE A SFERA PP-H
 elettrofusione

PP-H BALL VALVE
 socket fusion

DN	PN	D	EPDM	€	FPM	€
10	10	16	64910	50,39	65166	62,27
15	10	20	64911	50,39	65167	62,27
20	10	25	64912	59,06	65168	73,32
25	10	32	64913	73,92	65169	92,93
32	10	40	64914	91,51	65170	115,28
40	10	50	64915	114,32	65171	142,84
50	10	63	64916	141,41	65172	186,57
65	6	75	66927	313,13	67542	386,82
80	6	90	66928	374,82	67543	465,13
100	6	110	68509	705,80	68510	803,66

C08 | FAM VAL522

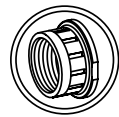
VALVOLE A SFERA PP-H
 filetto femmina BSP
 rinforzo in acciaio inossidabile

PP-H BALL VALVE
 female thread BSP
 Stainless steel reinforcement

DN	PN	G	EPDM	€	FPM	€
10	10	3/8"	64917	58,35	65173	70,24
15	10	1/2"	64918	58,35	65174	70,24
20	10	3/4"	64919	67,38	65175	81,64
25	10	1"	64920	83,90	65176	102,91
32	10	1 1/4"	64921	103,16	65177	126,91
40	10	1 1/2"	64922	128,94	65178	157,46
50	10	2"	64923	158,29	65179	203,45
65	6	2 1/2"	68558	333,82	68564	407,50
80	6	3"	68560	398,22	68565	488,54
100	6	4"	68562	738,53	68566	836,39

C08 | FAM VAL522

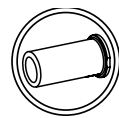
VALVOLE A SFERA PP-H
 saldatura testa a testa
 PP-H / SDR11

PP-H BALL VALVE
 butt fusion
 PP-H / SDR11

DN	PN	D	EPDM	€	FPM	€
15	10	20	64622	54,78	64539	66,67
20	10	25	64623	64,29	64846	78,55
25	10	32	64624	82,12	64847	101,13
32	10	40	64625	99,82	64848	123,59
40	10	50	64626	124,55	64849	153,90
50	10	63	64627	151,64	64850	196,80
65	6	75	68568	338,19	68571	411,86
80	6	90	68569	404,80	68572	495,12
100	6	110	68570	762,27	68573	860,13

PP-H

VALVOLE A SFERA PP-H SERIE EXTREME - PP-H BALL VALVE EXTREME SERIES

C08 | FAM VAL522

Accessori PVC-U

Valvole PVC-U

Accessori PVC-C

Valvole PVC-C

Valvole Extreme

Evacuazione

Ricambi:

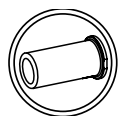

VALVOLE A SFERA PP-H

saldatura testa a testa
PE100 / SDR11

PP-H BALL VALVE

butt fusion
PE100 / SDR11



DN	PN	D	EPDM	€	FPM	€
15	10	20	65067	54,78	65181	66,67
20	10	25	65068	64,29	65182	78,55
25	10	32	65180	82,12	65183	101,13
32	10	40	65069	99,82	65184	123,59
40	10	50	65070	124,55	65185	153,90
50	10	63	65071	151,64	65186	196,80
65	6	75	67473	335,78	68575	409,45
80	6	90	67474	401,91	68576	492,22
100	6	110	68574	755,58	68577	853,44

C08 | FAM VAL522

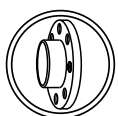

VALVOLE A SFERA PP-H

flangia ISO in acciaio
rivestita in PP
flangia libera (RF)

PP-H BALL VALVE

PP steel coated ISO flanges
loose flange (RF)



DN	PN	D	EPDM	€	FPM	€
15	10	20	72293	186,63	72299	200,13
20	10	25	72294	212,27	72300	228,47
25	10	32	72295	264,05	72301	285,65
32	10	40	72296	296,49	72302	323,49
40	10	50	72297	395,57	72303	427,97
50	10	63	72298	443,23	72304	494,54
65	6	75	72316	802,67	72319	886,38
80	6	90	72317	843,02	72320	945,63
100	6	110	72318	1.323,53	72321	1.436,94

C08 | FAM VAL522

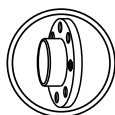

VALVOLE A SFERA PP-H

flangia ISO in PP-H
flangia fissa (FF)

PP-H BALL VALVE

PP-H ISO flanges
fixed flange (FF)

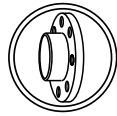

DN	PN	D	EPDM	€	FPM	€
15	10	20	66652	79,15	66658	91,27
20	10	25	66653	93,29	66659	107,83
25	10	32	66654	116,22	66660	135,62
32	10	40	66655	141,53	66661	165,78
40	10	50	66656	173,14	66662	202,24
50	10	63	66657	217,48	66663	263,54
65	6	75	67276	435,77	67277	509,46
80	6	90	67278	509,64	67279	599,96
100	6	110	68482	887,63	68483	980,83

**VALVOLE A SFERA PP-H**

flangia ANSI-150 in acciaio
 rivestita in PP
 flangia libera (RF)

PP-H BALL VALVE

PP steel coated ANSI-150 flanges
 loose flange (RF)



DN	PN	D	EPDM	€	FPM	€
15	10	½"	72293AB	186,63	72299AB	200,13
20	10	¾"	72294AB	212,27	72300AB	228,47
25	10	1"	72295AB	264,05	72301AB	285,65
32	10	1¼"	72296AB	296,49	72302AB	323,49
40	10	1½"	72297AB	395,57	72303AB	427,97
50	10	2"	72298AB	443,23	72304AB	494,54
65	6	2½"	72316AB	802,67	72319AB	886,38
80	6	3"	72317AB	843,02	72320AB	945,63
100	6	4"	72318AB	1.323,53	72321AB	1.436,94

PVDF

VALVOLE A SFERA PVDF SERIE EXTREME - PVDF BALL VALVE EXTREME SERIES

C08 | FAM VAL523

Accessori PVC-U

Valvole PVC-U

Accessori PVC-C

Valvole PVC-C

Valvole Extreme

Evacuazione

Ricambi

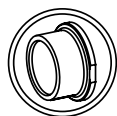

VALVOLE A SFERA PVDF
elettrofusione

PVDF BALL VALVE
socket fusion



DN	PN	D	EPDM	€	FPM	€
10	16	16	64924	78,79	64415	90,67
15	16	20	64925	78,79	64416	90,67
20	16	25	64926	97,93	64417	112,18
25	16	32	64927	126,91	64418	145,94
32	16	40	64928	166,37	64419	190,14
40	16	50	64929	247,77	64420	276,30
50	16	63	64930	342,25	64421	387,41
65	10	75	68632	884,42	68266	958,10
80	10	90	68633	1.141,17	68267	1.231,48
100	10	110	69320	1.675,38	69321	1.773,34

C08 | FAM VAL523

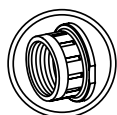

VALVOLE A SFERA PVDF
filetto femmina BSP
rinforzo in acciaio inossidabile

PVDF BALL VALVE
female thread BSP
Stainless steel reinforcement



DN	PN	G	EPDM	€	FPM	€
10	16	3/8"	66248	86,75	66317	98,63
15	16	1/2"	66249	86,75	66318	98,63
20	16	3/4"	66250	106,24	66319	120,51
25	16	1"	66251	136,90	66320	155,91
32	16	1 1/4"	66252	178,02	66321	201,79
40	16	1 1/2"	66253	262,40	66322	290,92
50	16	2"	66254	359,48	66323	404,64
65	10	2 1/2"	69322	942,83	69326	1.016,50
80	10	3"	69323	1.212,44	69328	1.302,76
100	10	4"	69324	1.753,07	69329	1.850,99

C08 | FAM VAL523



VALVOLE A SFERA PVDF
saldatura di tasca

PVDF BALL VALVE
spigot fusion



DN	PN	D	EPDM	€	FPM	€
15	16	20	67870	99,28	67877	112,49
20	16	25	67871	123,51	67878	139,27
25	16	32	67872	163,39	67879	184,04
32	16	40	67873	210,32	67880	236,24
40	16	50	67874	312,80	67881	344,95
50	16	63	67875	425,28	67882	473,54
65	10	75	70706	1.106,87	70711	1.192,25
80	10	90	70708	1.428,23	70712	1.532,90
100	10	110	70709	2.096,78	70713	2.210,26

PVDF

VALVOLE A SFERA PVDF SERIE EXTREME - PVDF BALL VALVE EXTREME SERIES

C08 | FAM VAL523

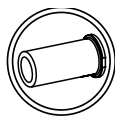
**VALVOLE A SFERA PVDF**saldatura testa a testa
PVDF - SDR11**PVDF BALL VALVE**butt fusion
PVDF - SDR11

DN	PN	D	EPDM	€	FPM	€
15	16	20	67175	85,67	67181	97,07
20	16	25	67176	106,59	67182	120,17
25	16	32	67177	141,00	67183	158,82
32	16	40	67178	181,49	67184	203,87
40	16	50	67179	269,92	67185	297,68
50	16	63	67180	366,98	67186	408,64
65	10	75	69330	955,16	69333	1.028,85
80	10	90	69331	1.232,48	69334	1.322,80
100	10	110	69332	1.809,40	69336	1.907,32

C08 | FAM VAL523

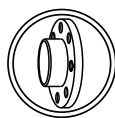
**VALVOLE A SFERA PVDF**flangia ISO in acciaio rivestita in PP
flangia libera (RF)**PVDF BALL VALVE**PP steel coated ISO flanges
loose flange (RF)

DN	PN	D	EPDM	€	FPM	€
15	16	20	67883	192,78	65990	204,43
20	16	25	67884	223,17	65991	236,80
25	16	32	67885	252,54	65992	271,18
32	16	40	67886	325,48	65993	348,78
40	16	50	67887	379,47	65994	407,43
50	16	63	67888	481,00	65995	525,27
65	10	75	68461	1.190,19	68462	1.263,88
80	10	90	68463	1.765,12	68464	1.855,43
100	10	110	68475	2.535,42	68476	2.632,68

C08 | FAM VAL523

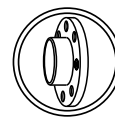
**VALVOLE A SFERA PVDF**flangia ANSI-150 in acciaio
rivestita in PP
flangia libera (RF)**PVDF BALL VALVE**PP steel coated ANSI-150 flanges
loose flange (RF)

DN	PN	D	EPDM	€	FPM	€
15	16	½"	67883AB	192,78	65990AB	204,43
20	16	¾"	67884AB	223,17	65991AB	236,80
25	16	1"	67885AB	252,54	65992AB	271,18
32	16	1¼"	67886AB	325,48	65993AB	348,78
40	16	1½"	67887AB	379,47	65994AB	407,43
50	16	2"	67888AB	481,00	65995AB	525,27
65	10	2½"	68461AB	1.190,19	68462AB	1.263,88
80	10	3"	68463AB	1.765,12	68464AB	1.855,43
100	10	4"	68475AB	2.535,42	68476AB	2.632,68

ABS

VALVOLE A SFERA ABS SERIE EXTREME - ABS BALL VALVE EXTREME SERIES

C08 | FAM VAL524

Accessori PVC-U

Valvole PVC-U

Accessori PVC-C

Valvole PVC-C

Valvole Extreme

Evacuazione

Ricambi

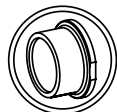

VALVOLE A SFERA ABS
incollaggio femmina ISO/DIN

ABS BALL VALVE
metric solvent socket ISO/DIN

DN	PN	D	EPDM	€	FPM	€
15	10	16	65187	57,51	65194	69,40
15	10	20	65188	57,51	65195	69,40
20	10	25	65189	67,38	65196	81,64
25	10	32	65190	84,62	65197	103,63
32	10	40	65191	104,58	65198	128,35
40	10	50	65192	132,14	65199	160,67
50	10	63	65193	166,37	65200	211,53
65	6	75	68634	350,80	68637	424,49
80	6	90	68635	440,89	68638	531,20
100	6	110	68636	621,43	68639	719,29

C08 | FAM VAL524

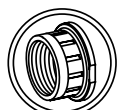

VALVOLE A SFERA ABS
filetto femmina BSP
rinforzo in acciaio inossidabile

ABS BALL VALVE
female thread BSP
Stainless steel reinforcement

DN	PN	G	EPDM	€	FPM	€
15	10	3/8"	65201	65,48	65214	77,36
15	10	1/2"	65202	65,48	65208	77,36
20	10	3/4"	65203	75,70	65209	89,96
25	10	1"	65204	94,59	65210	113,60
32	10	1 1/4"	65205	116,22	65211	139,99
40	10	1 1/2"	65206	146,76	65212	175,29
50	10	2"	65207	183,25	65213	228,41
65	6	2 1/2"	69490	371,48	69493	445,17
80	6	3"	69491	464,30	69494	554,62
100	6	4"	69492	639,15	69496	737,02

C08 | FAM VAL524

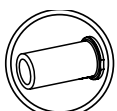

VALVOLE A SFERA ABS
saldatura testa a testa
PE100 / SDR11

ABS BALL VALVE
butt welding
PE100 / SDR11

DN	PN	D	EPDM	€	FPM	€
15	10	20	67890	61,91	67897	73,79
20	10	25	67891	72,60	67898	86,87
25	10	32	67892	92,81	67899	111,83
32	10	40	67893	112,90	67900	136,67
40	10	50	67894	143,20	67901	171,72
50	10	63	67895	176,60	67902	221,75
65	6	75	69497	372,36	69500	446,04
80	6	90	69498	467,96	69501	558,28
100	6	110	69499	659,59	69502	757,47

VALVOLE A MEMBRANA - SERIE EXTREME

DIAPHRAGM VALVES - EXTREME SERIES



Dimensioni Sizes	Incollaggio D16 - D63 (DN10-DN50) Filetto 3/8" - 2" (DN10-DN50) Solvent cement D16 - D63 (DN10-DN50) Threaded 3/8" - 2" (DN10-DN50)	
Manicotti: standard normativi Standard end connections	Incollaggio - Metrico ASTM, British standard Filetto - BSP, NPT Flange - DIN, ANSI Saldatura testa a testa - SDR11 Solvent socket - Metric, ASTM, British standard Threaded - BSP, NPT Flanges - DIN, ANSI Butt welding - SDR11	EN ISO 1452, EN ISO 15493, BS 4346-1, ASTM D 2467 ISO 228-1, ASTM D 2464 EN558 Serie 1 DIN 3202-1, ANSI ASME B16.5
Pressione di lavoro Working pressure	@ 20°C (73°F) D16 - D63 (3/8" - 2"): PN 10 (150 psi)	
Materiali Materials	Corpo/Body: PVC-U / PVC-C / PP-H	O-rings / membrana: EPDM / FPM O-rings / diaphragm: EPDM / FPM
Caratteristiche Characteristics	<ul style="list-style-type: none"> • Eccellenti caratteristiche di conduzione e minime perdite di carico. • Dispositivo di sicurezza incorporato nel volantino. • Indicatore visuale di posizione. • Testate al 100% in fabbrica. (con aria e acqua). • Copertura di protezione nelle viti di chiusura. • Ridotta coppia di manovra. • Resistente a molti composti chimici inorganici. • Eccellenti caratteristiche di conduzione. 	<ul style="list-style-type: none"> • Excellent flow characteristics and minimal pressure drop. • Safety device incorporated in the handle. • Visual position indicator. • 100% factory tested (with air and water). • Protection in the closing bolts. • Very low operating torque. • Resistance to many inorganic chemicals. • Excellent flow characteristics.
Certificazioni Certifications	Valvola a sfera con certificazione- EN ISO 16138 Ball valve design regulation - EN ISO 16138 Certificato/Certificate - ACS (Attestation de Conformité Sanitaire)	

Accessori PVC-U

Valvole PVC-U

Accessori PVC-C

Valvole PVC-C

Valvole Extreme

Evacuazione

Ricambi

PVC-U

VALVOLE A MEMBRANA PVC-U SERIE EXTREME - PVC-U DIAPHRAGM VALVE EXTREME SERIES

C08 | FAM VDI620

Accessori PVC-U

Valvole PVC-U

Accessori PVC-C

Valvole PVC-C

Valvole Extreme

Evacuazione

Ricambi

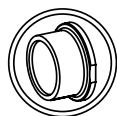

VALVOLE A MEMBRANA PVC-U
incollaggio femmina ISO/DIN

PVC-U DIAPHRAGM VALVE
solvent socket ISO/DIN

DN	PN	D	EPDM	€	FPM	€
15	10	20	54817	78,08	56786	149,14
20	10	25	54818	84,37	56794	155,44
25	10	32	56663	100,54	57245	242,43
32	10	40	56664	116,70	57251	258,59
40	10	50	56675	137,26	57295	333,34
50	10	63	56676	168,51	57301	364,59

C08 | FAM VDI620

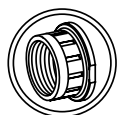

VALVOLE A MEMBRANA PVC-U
filetto femmina BSP
rinforzo in acciaio inossidabile

PVC-U DIAPHRAGM VALVE
female thread BSP
Stainless steel reinforcement

DN	PN	G	EPDM	€	FPM	€
15	10	½"	54819	86,40	56787	157,46
20	10	¾"	54820	93,17	56795	164,23
25	10	1"	56665	111,12	57246	253,00
32	10	1¼"	56666	128,94	57252	270,83
40	10	1½"	56677	152,71	57296	348,79
50	10	2"	56678	186,22	57302	382,30

C08 | FAM VDI620

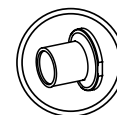

VALVOLE A MEMBRANA PVC-U
incollaggio maschio ISO/DIN

PVC-U DIAPHRAGM VALVE
male solvent socket ISO/DIN

DN	PN	D	EPDM	€	FPM	€
15	10	20	54815	65,59	56784	136,67
20	10	25	54816	71,42	56792	142,48
25	10	32	56659	90,91	57243	232,80
32	10	40	56660	103,03	57249	244,92
40	10	50	56671	123,59	57293	319,67
50	10	63	56672	146,05	57299	342,13

C08 | FAM VDI620

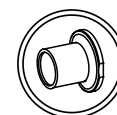

VALVOLE A MEMBRANA PVC-U
incollaggio maschio ISO/DIN
attacchi a bocchettone

PVC-U DIAPHRAGM VALVE
male solvent socket ISO/DIN
true union

DN	PN	D	EPDM	€	FPM	€
15	10	20	66849	82,55	68601	153,62
20	10	25	66850	89,07	68602	160,13
25	10	32	66851	104,47	68603	246,37
32	10	40	66852	121,06	68604	262,96
40	10	50	66866	139,47	68605	335,55
50	10	63	66867	174,28	68606	370,37

PVC-U

VALVOLE A MEMBRANA PVC-U SERIE EXTREME - PVC-U DIAPHRAGM VALVE EXTREME SERIES

C08 | FAM VDI620

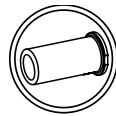
VALVOLE A MEMBRANA PVC-U
 PE100 / SDR11

PVC-U DIAPHRAGM VALVE
 PE100 / SDR11

DN	PN	D	EPDM	€	FPM	€
15	10	20	64977	86,40	66914	157,46
20	10	25	64978	93,17	66915	164,24
25	10	32	64979	111,12	66916	253,36
32	10	40	64980	128,94	66917	270,83
40	10	50	64981	152,71	66918	348,79
50	10	63	64982	186,22	66919	382,30

C08 | FAM VDI620

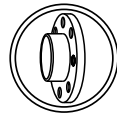
VALVOLE A MEMBRANA PVC-U
 flangia ISO in PVC-U
 flangia libera (RF)

PVC-U DIAPHRAGM VALVE
 PVC-U ISO flanges
 loose flange (RF)

DN	PN	D	EPDM	€	FPM	€
15	10	20	54823	84,85	56790	155,91
20	10	25	54824	94,95	56797	166,02
25	10	32	56669	111,59	57248	253,49
32	10	40	56670	131,79	57254	273,69
40	10	50	56679	155,91	57298	352,00
50	10	63	56680	192,40	57304	388,48

C08 | FAM VDI620

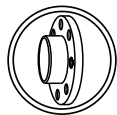
VALVOLE A MEMBRANA PVC-U
 flangia ANSI-150 in PVC-U
 flangia fissa (FF)

PVC-U DIAPHRAGM VALVE
 PVC-U ANSI-150 flanges
 fixed flange (FF)

DN	PN	D	EPDM	€	FPM	€
15	10	½"	54823AB	96,77	56790AB	167,83
20	10	¾"	54824AB	107,97	56797AB	179,03
25	10	1"	56669AB	126,29	57248AB	268,19
32	10	1¼"	56670AB	146,31	57254AB	288,21
40	10	1½"	56679AB	177,72	57298AB	373,80
50	10	2"	56680AB	216,85	57304AB	412,92

PVC-C

VALVOLE A MEMBRANA PVC-C SERIE EXTREME - CPVC DIAPHRAGM VALVE EXTREME SERIES

C08 | FAM VDI621

Accessori PVC-U

Valvole PVC-U

Accessori PVC-C

Valvole PVC-C

Valvole Extreme

Evacuazione

Ricambi

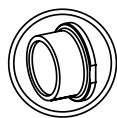

VALVOLE A MEMBRANA PVC-C
incollaggio femmina ISO/DIN

CPVC DIAPHRAGM VALVE
metric solvent socket ISO/DIN



DN	PN	D	EPDM	€	FPM	€
15	10	20	56802	97,93	56819	168,99
20	10	25	56807	112,06	56859	183,13
25	10	32	57257	128,82	57267	270,72
32	10	40	57262	163,99	57272	305,89
40	10	50	57307	180,40	57320	376,48
50	10	63	57312	237,91	57325	433,99

C08 | FAM VDI621

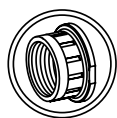

VALVOLE A MEMBRANA PVC-C
filetto femmina BSP
rinforzo in acciaio inossidabile

CPVC DIAPHRAGM VALVE
female thread BSP
Stainless steel reinforcement



DN	PN	G	EPDM	€	FPM	€
15	10	½"	56803	106,71	56820	177,78
20	10	¾"	56808	121,21	56860	192,28
25	10	1"	57258	139,75	57268	281,65
32	10	1¼"	57263	176,83	57273	318,73
40	10	1½"	57308	196,56	57321	392,64
50	10	2"	57313	256,57	57326	452,65

C08 | FAM VDI621

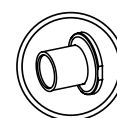

VALVOLE A MEMBRANA PVC-C
incollaggio maschio ISO/DIN

CPVC DIAPHRAGM VALVE
male solvent socket ISO/DIN



DN	PN	D	EPDM	€	FPM	€
15	10	20	56800	82,36	56817	153,42
20	10	25	56805	94,36	56857	165,42
25	10	32	57255	115,87	57265	257,76
32	10	40	57260	142,01	57270	283,90
40	10	50	57305	162,45	57318	358,54
50	10	63	57310	201,55	57323	397,63

C08 | FAM VDI621

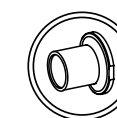

VALVOLE A MEMBRANA PVC-C
incollaggio maschio ISO/DIN
attacchi a bocchettone

CPVC DIAPHRAGM VALVE
metric male solvent socket ISO/DIN
true union



DN	PN	D	EPDM	€	FPM	€
15	10	20	66881	98,44	69096	171,84
20	10	25	66882	112,50	69097	183,57
25	10	32	66883	128,92	69098	270,81
32	10	40	66884	163,80	69099	305,70
40	10	50	66885	184,41	69100	380,50
50	10	63	66886	243,74	69101	439,83

PVC-C

VALVOLE A MEMBRANA PVC-C SERIE EXTREME - CPVC DIAPHRAGM VALVE EXTREME SERIES

C08 | FAM VDI621

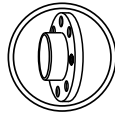
**VALVOLE A MEMBRANA PVC-C**
 flangia ISO in PVC-C
 flangia libera (RF)
CPVC DIAPHRAGM VALVE
 CPVC ISO flanges
 loose flange (RF)

DN	PN	D	EPDM	€	FPM	€
15	10	20	56804	110,87	56821	181,94
20	10	25	56809	138,92	56861	209,99
25	10	32	57259	148,90	57269	290,80
32	10	40	57264	209,52	57274	351,40
40	10	50	57309	248,73	57322	444,80
50	10	63	57314	345,94	57327	542,02

C08 | FAM VDI621

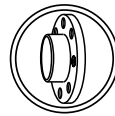
**VALVOLE A MEMBRANA PVC-C**
 flangia ANSI-150 in PVC-C
 flangia fissa (FF)
CPVC DIAPHRAGM VALVE
 CPVC ANSI-150 flanges
 fixed flange (FF)

DN	PN	D	EPDM	€	FPM	€
15	10	½"	56804AB	122,79	56821AB	193,85
20	10	¾"	56809AB	152,64	56861AB	223,70
25	10	1"	57259AB	164,20	57269AB	306,08
32	10	1¼"	57264AB	223,60	57274AB	365,48
40	10	1½"	57309AB	266,17	57322AB	462,25
50	10	2"	57314AB	379,63	57327AB	575,71

PP-H

VALVOLE A MEMBRANA PP-H SERIE EXTREME - PP-H DIAPHRAGM VALVE EXTREME SERIES

C08 | FAM VDI622

Accessori PVC-U

Valvole PVC-U

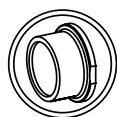

VALVOLE A MEMBRANA PP-H
elettrofusione

PP-H DIAPHRAGM VALVE
socket fusion

DN	PN	D	EPDM	€	FPM	€
15	10	20	56864	90,20	56872	161,26
20	10	25	56867	97,33	56877	168,40
25	10	32	57277	116,22	57283	258,11
32	10	40	57280	133,82	57286	275,70
40	10	50	57330	158,17	57336	354,25
50	10	63	57333	192,16	57339	388,24

C08 | FAM VDI622

Accessori PVC-C

Valvole PVC-C

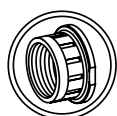

VALVOLE A MEMBRANA PP-H
filetto femmina BSP
rinforzo in acciaio inossidabile

PP-H DIAPHRAGM VALVE
female thread BSP
Stainless steel reinforcement

DN	PN	G	EPDM	€	FPM	€
15	10	½"	63056	98,99	63062	170,06
20	10	¾"	63057	106,48	63063	177,54
25	10	1"	63058	127,28	63064	269,16
32	10	1¼"	63059	146,64	63065	288,54
40	10	1½"	63060	174,33	63066	370,42
50	10	2"	63061	210,82	63067	406,90

C08 | FAM VDI622

Valvole Extreme

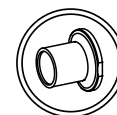

VALVOLE A MEMBRANA PP-H
elettrofusione maschio

PP-H DIAPHRAGM VALVE
spigot fusion

DN	PN	D	EPDM	€	FPM	€
15	10	20	56862	75,82	56868	146,88
20	10	25	56865	82,24	56874	153,30
25	10	32	57275	104,82	57281	246,71
32	10	40	57278	118,01	57284	259,89
40	10	50	57328	142,37	57334	338,44
50	10	63	57331	167,09	57337	363,17

C08 | FAM VDI622

Evacuazione

Ricambi:

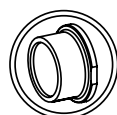

VALVOLE A MEMBRANA PP-H
elettrofusione maschio
attacco a bocchettone

PP-H DIAPHRAGM VALVE
spigot fusion
true union

DN	PN	D	EPDM	€	FPM	€
15	10	20	66853	99,00	67189	170,06
20	10	25	66854	106,49	67190	177,55
25	10	32	66855	127,29	67191	269,16
32	10	40	66856	146,64	67192	288,54
40	10	50	66857	174,33	67193	370,41
50	10	63	66858	210,82	67194	406,90

PP-H

VALVOLE A MEMBRANA PP-H SERIE EXTREME - PP-H DIAPHRAGM VALVE EXTREME SERIES

C08 | FAM VDI622

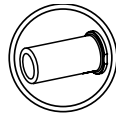
**VALVOLE A MEMBRANA PP-H**saldatura testa a testa
PE100 / SDR11**PP-H DIAPHRAGM VALVE**butt fusion
PE100 / SDR11

DN	PN	D	EPDM	€	FPM	€
15	10	20	64566	98,99	67195	170,06
20	10	25	64567	106,48	67196	177,55
25	10	32	64568	127,28	67197	269,16
32	10	40	62860	146,64	67198	288,54
40	10	50	64569	174,33	67199	370,41
50	10	63	62861	210,82	67200	406,90

C08 | FAM VDI622

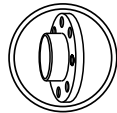
**VALVOLE A MEMBRANA PP-H**flangia ISO in PP-H
flangia fissa (FF)**PP-H DIAPHRAGM VALVE**PP-H ISO flanges
fixed flange (FF)

DN	PN	D	EPDM	€	FPM	€
15	10	20	67449	118,95	67455	190,01
20	10	25	67450	131,56	67456	202,61
25	10	32	67451	158,55	67457	300,42
32	10	40	67452	183,84	67458	325,72
40	10	50	67453	217,00	67459	413,07
50	10	63	67454	268,21	67460	464,30

C08 | FAM VDI622

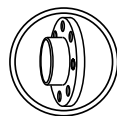
**VALVOLE A MEMBRANA PP-H**flangia ANSI-150 in acciaio
rivestita in PP
flangia libera (RF)**PP-H DIAPHRAGM VALVE**PP steel coated ANSI-150 flanges
loose flange (RF)

DN	PN	D	EPDM	€	FPM	€
15	10	½"	67449AB	200,86	67455AB	272,04
20	10	¾"	67450AB	221,44	67456AB	292,50
25	10	1"	67451AB	270,17	67457AB	412,06
32	10	1¼"	67452AB	298,15	67458AB	440,04
40	10	1½"	67453AB	385,21	67459AB	581,29
50	10	2"	67454AB	433,22	67460AB	629,65

VALVOLE A FARFALLA - SERIE EXTREME BUTTERFLY VALVES - EXTREME SERIES



Dimensioni Sizes	D50 - D315 (DN40 - DN300) 1½" - 12" (DN40 - DN300)	
Standard	ISO/DIN, British Standard, ANSI/ASTM,	EN 558-1 BS EN 1092-1 ANSI B16.5 class 150
Pressione di lavoro Working pressure	@ 20°C (73°F) D50-D225 (1½" - 8"): PN 10 (150 psi) D250 - D315 (10" - 12"): PN 6 (90 psi)	
Materiali Materials	Corpo/Body: PP - GR Disco/Disc: PVC-U / PVC-C / PP-H / PVDF / ABS	Guarnizione/Gasket: EPDM perox. / FPM Perno/Shaft: Stainless steel (AISI 630)
Caratteristiche Characteristics	<ul style="list-style-type: none"> • Corpo monoblocco in PP - GR. • Lente disponibile in PVC-U, PVC-C, PP-H, PVDF, ABS. • Indicata per il controllo dei fluidi e di ingombri ridotti. • Testate al 100% in fabbrica. • Minime perdite di carico. • Resistente a molti composti chimici inorganici. • Apertura regolabile ogni 15° con fissaggio posizione. • Buona resistenza meccanica. • Sistema di sicurezza incorporato per prevenire operazioni indesiderate. • Disponibile con attuazione elettrica, pneumatica o con riduttore manuale. 	<ul style="list-style-type: none"> • One piece PP - GR body. • Disc available in different materials (PVC-U, PVC-C, PP-H, PVDF, ABS). • Ideally suited for flow control using minimal piping space. • 100% factory tested (with air and water). • Minimal pressure drop. • Low maintenance. • Resistance to many inorganic chemicals. • Regulable opening every 15° with position holding. • Good mechanical strength. • Built in lockout feature to prevent undesired operations. • Electric and pneumatic actuators available, and with gear box.
Certificazioni Certifications	Valvola a farfalla certificata - ISO 16136 Butterfly valve design regulation - ISO 16136	



PVC-U

VALVOLE A FARFALLA PVC-U SERIE EXTREME - PVC-U BUTTERFLY VALVE EXTREME SERIES

C08 | FAMVMA520

**VALVOLE A FARFALLA PVC-U**

Corpo in PP - GR
 Lente in PVC-U
 con maniglia

PVC-U BUTTERFLY VALVE

Body in PP - GR
 Disc in PVC-U
 handle

DN	PN	D	EPDM	€	FPM	€
40	10	50	66725	195,08	66726	277,79
65	10	63-75	61365	243,85	61460	347,24
80	10	90	61366	274,39	61461	387,05
100	10	110	61367	327,88	61462	482,60
125	10	125-140	61368	397,04	61463	610,23
150	10	160	61369	452,53	61464	697,10
200	10	200-225	61370	638,63	61465	1.060,75

C08 | FAMVMA520

**VALVOLE A FARFALLA PVC-U**

Corpo in PP - GR
 Lente in PVC-U
 a stelo libero

PVC-U BUTTERFLY VALVE

Body in PP - GR
 Disc in PVC-U
 bare shaft

DN	PN	D	EPDM	€	FPM	€
40	10	50	66727	170,13	66729	253,20
65	10	63-75	61466	219,26	61474	322,65
80	10	90	61467	248,37	61475	361,02
100	10	110	61468	301,85	61476	456,57
125	10	125-140	61469	368,16	61477	581,35
150	10	160	61470	423,66	61478	668,22
200	10	200-225	61471	599,66	61479	1.021,76
250	6	250-280	61472	1.238,29	61480	2.078,47
300	6	315	61473	1.580,54	61481	2.631,06

* È necessario aggiungere il kit di attuazione per montare un attuatore o un riduttore manuale

* It is needed to add the actuation kit for the assembly of an actuator or gear box

C08 | FAMVMA520

**VALVOLE A FARFALLA PVC-U**

Corpo in PP - GR
 Lente in PVC-U
 riduttore manuale

PVC-U BUTTERFLY VALVE

Body in PP - GR
 Disc in PVC-U
 gear box

DN	PN	D	EPDM	€	FPM	€
40	10	50	66730	462,30	66731	545,17
65	10	63-75	61482	511,24	61490	614,63
80	10	90	61483	541,78	61491	654,44
100	10	110	61484	595,26	61492	749,99
125	10	125-140	61485	720,99	61493	934,18
150	10	160	61486	669,53	61494	1.021,06
200	10	200-225	61487	967,45	61495	1.389,57
250	6	250-280	61488	1.775,91	61496	2.616,09
300	6	315	61489	2.128,50	61497	3.179,02

PVC-U

VALVOLE A FARFALLA PVC-U SERIE EXTREME VERSIONE LUG - PVC-U BUTTERFLY VALVE EXTREME SERIES LUG STYLE

C08 | FAM VMA525

Accessori PVC-U

Valvole PVC-U

Accessori PVC-C

Valvole PVC-C

Valvole Extreme

Evacuazione

Ricambi

VALVOLE A FARFALLA PVC-U
Corpo in PP - GR - VERSIONE LUG
Lente in PVC-U
con maniglia

PVC-U BUTTERFLY VALVE
Body in PP - GR - LUG STYLE
Disc in PVC-U
handle



DN	PN	D	EPDM	€	FPM	€
50	10	63	72374	386,40	72375	489,80
65	10	75	66132	386,40	68857	489,79
80	10	90	66133	544,52	68858	657,18
100	10	110	66134	596,70	68859	751,42
125	10	125-140	66135	763,22	68860	976,42
150	10	160	66136	1.101,89	68861	1.346,45
200	10	200-225	66137	1.275,06	68862	1.697,17

C08 | FAM VMA520

VALVOLE A FARFALLA PVC-U
Corpo in PP - GR - VERSIONE LUG
Lente in PVC-U
a stelo libero

PVC-U BUTTERFLY VALVE
Body in PP - GR - LUG STYLE
Disc in PVC-U
bare shaft



DN	PN	D	EPDM	€	FPM	€
50	10	63	72376	361,81	72377	465,20
65	10	75	68864	361,81	68873	465,20
80	10	90	68865	518,50	68874	631,15
100	10	110	68866	570,67	68875	725,39
125	10	125-140	68867	734,35	68876	947,54
150	10	160	68868	1.073,01	68877	1.317,58
200	10	200-225	68869	1.236,08	68878	1.658,20
250	6	280	68870	2.233,59	68879	3.073,78
300	6	315	68871	2.606,64	68880	3.657,17

* È necessario aggiungere il kit di attuazione per montare un attuatore o un riduttore manuale

* It is needed to add the actuation kit for the assembly of an actuator or gear box

C08 | FAM VMA520

VALVOLE A FARFALLA PVC-U
Corpo in PP - GR - VERSIONE LUG
Lente in PVC-U
riduttore manuale

PVC-U BUTTERFLY VALVE
Body in PP - GR - LUG STYLE
Disc in PVC-U
gear box



DN	PN	D	EPDM	€	FPM	€
50	10	63	72378	653,78	72379	757,17
65	10	75	68882	653,78	68891	757,18
80	10	90	68883	811,90	68892	924,57
100	10	110	68884	864,08	68893	1.018,81
125	10	125-140	68885	1.087,18	68894	1.300,37
150	10	160	68886	1.318,89	68895	1.670,40
200	10	200-225	68887	1.603,89	68896	2.025,99
250	6	280	68888	2.771,21	68897	3.611,40
300	6	315	68889	3.154,60	68898	4.205,13

PVC-C

VALVOLE A FARFALLA PVC-C SERIE EXTREME - CPVC BUTTERFLY VALVE EXTREME SERIES

C08 | FAM VMA521

**VALVOLE A FARFALLA PVC-C**Corpo in PP - GR
Lente in PVC-C
con maniglia**CPVC BUTTERFLY VALVE**Body in PP - GR
Disc in CPVC
handle

DN	PN	D	EPDM	€	FPM	€
40	10	50	66734	216,19	66735	298,90
65	10	63-75	61498	270,23	61504	373,63
80	10	90	61499	302,32	61505	414,98
100	10	110	61500	362,93	61506	517,65
125	10	125-140	61501	444,22	61507	657,41
150	10	160	61502	516,23	61508	760,80
200	10	200-225	61503	752,95	61509	1.175,07

C08 | FAM VMA521

**VALVOLE A FARFALLA PVC-C**Corpo in PP - GR
Lente in PVC-C
a stelo libero**CPVC BUTTERFLY VALVE**Body in PP - GR
Disc in CPVC
bare shaft

DN	PN	D	EPDM	€	FPM	€
40	10	50	66732	190,60	66733	273,90
65	10	63-75	61510	245,64	61518	349,02
80	10	90	61511	276,30	61519	388,95
100	10	110	61512	336,90	61520	491,64
125	10	125-140	61513	415,33	61521	628,54
150	10	160	61514	487,35	61522	731,92
200	10	200-225	61515	713,98	61523	1.136,09
250	6	280	61516	1.317,07	61524	2.157,26
300	6	315	61517	1.704,13	61525	2.754,65

* È necessario aggiungere il kit di attuazione per montare un attuatore o un riduttore manuale

* It is needed to add the actuation kit for the assembly of an actuator or gear box

C08 | FAM VMA521

**VALVOLE A FARFALLA PVC-C**Corpo in PP - GR
Lente in PVC-C
riduttore manuale**CPVC BUTTERFLY VALVE**Body in PP - GR
Disc in CPVC
gear box

DN	PN	D	EPDM	€	FPM	€
40	10	50	66736	486,16	66737	568,58
65	10	63-75	61526	537,62	61534	641,01
80	10	90	61527	569,70	61535	682,37
100	10	110	61528	630,32	61536	785,04
125	10	125-140	61529	768,17	61537	981,36
150	10	160	61530	840,19	61538	1.084,75
200	10	200-225	61531	1.081,78	61539	1.503,89
250	6	250-280	61532	1.854,70	61540	2.694,88
300	6	315	61533	2.252,09	61541	3.302,62

PVC-C

VALVOLE A FARFALLA PVC-C SERIE EXTREME VERSIONE LUG - CPVC BUTTERFLY VALVE EXTREME SERIES LUG STYLE

C08 | FAM VMA525

Accessori PVC-U

Valvole PVC-U

Accessori PVC-C

Valvole PVC-C

Valvole Extreme

Evacuazione

Ricambi



VALVOLE A FARFALLA PVC-C

Corpo in PP - GR - VERSIONE LUG
Lente in PVC-C
con maniglia

CPVC BUTTERFLY VALVE

Body in PP - GR - LUG STYLE
Disc in CPVC
handle

DN	PN	D	EPDM	€	FPM	€
50	10	63	72380	412,78	72381	516,17
65	10	75	62345	412,78	63189	516,18
80	10	90	62346	572,45	63190	685,11
100	10	110	68900	631,75	63191	786,47
125	10	125-140	68901	810,40	63192	1.023,60
150	10	160	68902	1.165,58	63193	1.410,15
200	10	200-225	68903	1.389,38	63194	1.811,50

C08 | FAM VMA521



VALVOLE A FARFALLA PVC-C

Corpo in PP - GR - VERSIONE LUG
Lente in PVC-C
a stelo libero

CPVC BUTTERFLY VALVE

Body in PP - GR - LUG STYLE
Disc in CPVC
bare shaft

DN	PN	D	EPDM	€	FPM	€
50	10	63	72382	388,19	72383	491,57
65	10	75	68906	388,19	68915	491,57
80	10	90	68907	546,43	68916	659,08
100	10	110	68908	605,72	68917	760,46
125	10	125-140	68909	781,52	68918	994,72
150	10	160	68910	1.136,71	68919	1.381,28
200	10	200-225	68911	1.350,40	68920	1.772,52
250	6	280	68912	2.312,38	68921	3.152,56
300	6	315	68913	2.730,23	68922	3.780,76

* È necessario aggiungere il kit di attuazione per montare un attuatore o un riduttore manuale

* It is needed to add the actuation kit for the assembly of an actuator or gear box

C08 | FAM VMA521



VALVOLE A FARFALLA PVC-C

Corpo in PP - GR - VERSIONE LUG
Lente in PVC-C
riduttore manuale

CPVC BUTTERFLY VALVE

Body in PP - GR - LUG STYLE
Disc in CPVC
gear box

DN	PN	D	EPDM	€	FPM	€
50	10	63	72384	680,17	72385	783,56
65	10	75	68924	680,17	68933	783,56
80	10	90	68925	839,83	68934	952,49
100	10	110	68926	899,14	68935	1.053,86
125	10	125-140	68927	1.134,35	68936	1.347,55
150	10	160	68928	1.489,53	68937	1.734,10
200	10	200-225	68929	1.718,21	68938	2.140,32
250	6	280	68930	2.850,01	68939	3.690,18
300	6	315	68931	3.278,19	68940	4.328,72

PP-H

VALVOLE A FARFALLA PP-H SERIE EXTREME - PP-H BUTTERFLY VALVE EXTREME SERIES

C08 | FAM VMA522

**VALVOLE A FARFALLA PP-H**

Corpo in PP - GR
 Lente in PP-H
 con maniglia

PP-H BUTTERFLY VALVE

Body in PP - GR
 Disc in PP-H
 handle

DN	PN	D	EPDM	€	FPM	€
40	10	50	66738	195,08	66739	277,79
65	10	63-75	61542	243,85	61962	347,24
80	10	90	61543	274,39	61963	387,05
100	10	110	61544	327,88	61964	482,60
125	10	125-140	61545	397,04	61965	610,23
150	10	160	61546	452,53	61966	697,10
200	10	200-225	61549	638,63	61967	1.060,75

C08 | FAM VMA522

**VALVOLE A FARFALLA PP-H**

Corpo in PP - GR
 Lente in PP-H
 a stelo libero

PP-H BUTTERFLY VALVE

Body in PP - GR
 Disc in PP-H
 bare shaft

DN	PN	D	EPDM	€	FPM	€
40	10	50	66740	170,13	66741	253,20
65	10	63-75	61968	219,26	61976	322,65
80	10	90	61969	248,37	61977	361,02
100	10	110	61970	301,85	61978	456,57
125	10	125-140	61971	368,16	61979	581,35
150	10	160	61972	423,66	61980	668,22
200	10	200-225	61973	599,66	61981	1.021,76
250	6	250-280	61974	1.238,29	61982	2.078,47
300	6	315	61975	1.580,54	61983	2.631,06

* È necessario aggiungere il kit di attuazione per montare un attuatore o un riduttore manuale

* It is needed to add the actuation kit for the assembly of an actuator or gear box

C08 | FAM VMA522

**VALVOLE A FARFALLA PP-H**

Corpo in PP - GR
 Lente in PP-H
 riduttore manuale

PP-H BUTTERFLY VALVE

Body in PP - GR
 Disc in PP-H
 gear box

DN	PN	D	EPDM	€	FPM	€
40	10	50	66742	462,30	66743	545,17
65	10	63-75	61984	511,24	61992	614,63
80	10	90	61985	541,78	61993	654,44
100	10	110	61986	595,26	61994	749,99
125	10	125-140	61987	720,99	62000	934,18
150	10	160	61988	776,49	62006	1.021,06
200	10	200-225	61989	967,45	62007	1.389,57
250	6	250-280	61990	1.775,91	62008	2.616,09
300	6	315	61991	2.128,50	62009	3.179,02

PP-H

VALVOLE A FARFALLA PP-H SERIE EXTREME VERSIONE LUG - PP-H BUTTERFLY VALVE EXTREME SERIES LUG STYLE

C08 | FAM VMA525

Accessori PVC-U

Valvole PVC-U

Accessori PVC-C

Valvole PVC-C

Valvole Extreme

Evacuazione

Ricambi:



VALVOLE A FARFALLA PP-H
Corpo in PP - GR - VERSIONE LUG
Lente in PP-H
con maniglia

PP-H BUTTERFLY VALVE
Body in PP - GR - LUG STYLE
Disc in PP-H
handle

DN	PN	D	EPDM	€	FPM	€
50	10	63	72386	386,40	72387	489,80
65	10	75	65119	386,40	68942	489,79
80	10	90	65120	544,52	68943	657,18
100	10	110	65121	596,70	68944	751,42
125	10	125-140	65122	763,22	68945	976,42
150	10	160	65123	1.101,89	68946	1.346,45
200	10	200-225	65124	1.275,06	68947	1.697,17

C08 | FAM VMA522

VALVOLE A FARFALLA PP-H
Corpo in PP - GR - VERSIONE LUG
Lente in PP-H
a stelo libero

PP-H BUTTERFLY VALVE
Body in PP - GR - LUG STYLE
Disc in PP-H
bare shaft



DN	PN	D	EPDM	€	FPM	€
50	10	63	72388	361,81	72389	465,20
65	10	75	68949	361,81	68958	465,20
80	10	90	68950	518,50	68959	631,15
100	10	110	68951	570,67	68960	725,39
125	10	125-140	68952	734,35	68961	947,54
150	10	160	68953	1.073,01	68962	1.317,58
200	10	200-225	68954	1.236,08	68963	1.658,20
250	6	280	68955	2.233,59	68964	3.073,78
300	6	315	68956	2.606,64	68965	3.657,17

* È necessario aggiungere il kit di attuazione per montare un attuatore o un riduttore manuale

* It is needed to add the actuation kit for the assembly of an actuator or gear box

C08 | FAM VMA522

VALVOLE A FARFALLA PP-H
Corpo in PP - GR - VERSIONE LUG
Lente in PP-H
riduttore manuale

PP-H BUTTERFLY VALVE
Body in PP - GR - LUG STYLE
Disc in PP-H
gear box



DN	PN	D	EPDM	€	FPM	€
50	10	63	72390	653,78	72391	757,17
65	10	75	68967	653,78	68976	757,18
80	10	90	68968	811,90	68977	924,57
100	10	110	68969	864,08	68978	1.018,81
125	10	125-140	68970	1.087,18	68979	1.300,37
150	10	160	68971	1.425,84	68980	1.670,40
200	10	200-225	68972	1.603,89	68981	2.025,99
250	6	280	68973	2.771,21	68982	3.611,40
300	6	315	68974	3.154,60	68983	4.205,13

PVDF

VALVOLE A FARFALLA PVDF SERIE EXTREME - PVDF BUTTERFLY VALVE EXTREME SERIES

C08 | FAM VMA523

**VALVOLE A FARFALLA PVDF**Corpo in PP - GR
Lente in PVDF
con maniglia**PVDF BUTTERFLY VALVE**Body in PP - GR
Disc in PVDF
handle

DN	PN	D	EPDM	€	FPM	€
40	10	50	66744	224,27	66745	306,98
65	10	63-75	64634	280,34	62047	383,73
80	10	90	64635	316,23	62048	428,88
100	10	110	64636	391,09	62049	545,82
125	10	125-140	64637	504,34	62050	717,55
150	10	160	64638	603,70	62051	848,27
200	10	200-225	64639	955,45	62052	1.377,57

C08 | FAM VMA523

**VALVOLE A FARFALLA PVDF**Corpo in PP - GR
Lente in PVDF
a stelo libero**PVDF BUTTERFLY VALVE**Body in PP - GR
Disc in PVDF
bare shaft

DN	PN	D	EPDM	€	FPM	€
40	10	50	66746	198,45	66747	281,82
65	10	63-75	64640	255,74	62053	359,13
80	10	90	64641	290,20	62054	402,86
100	10	110	64642	365,07	62055	519,80
125	10	125-140	64643	475,47	62056	688,67
150	10	160	64644	574,82	62057	819,38
200	10	200-225	64645	916,48	62058	1.338,59
250	6	250-280	64646	1.787,79	62059	2.627,98
300	6	315	64647	2.495,59	62060	3.546,11

* È necessario aggiungere il kit di attuazione per montare un attuatore o un riduttore manuale

* It is needed to add the actuation kit for the assembly of an actuator or gear box

C08 | FAM VMA523

**VALVOLE A FARFALLA PVDF**Corpo in PP - GR
Lente in PVDF
riduttore manuale**PVDF BUTTERFLY VALVE**Body in PP - GR
Disc in PVDF
gear box

DN	PN	D	EPDM	€	FPM	€
40	10	50	66748	495,30	66749	588,79
65	10	63-75	64648	547,72	62061	651,12
80	10	90	64649	583,61	62062	696,28
100	10	110	64650	664,43	62063	813,20
125	10	125-140	64651	828,30	62064	1.041,49
150	10	160	64652	927,65	62065	1.172,21
200	10	200-225	64653	1.284,28	62066	1.706,39
250	6	250-280	64654	2.325,42	62067	3.165,60
300	6	315	64655	3.043,56	62068	4.094,07

PVDF

VALVOLE A FARFALLA PVDF SERIE EXTREME VERSIONE LUG - PVDF BUTTERFLY VALVE EXTREME SERIES LUG STYLE

C08 | FAM VMA525

Accessori PVC-U

Valvole PVC-U

Accessori PVC-C

Valvole PVC-C

Valvole Extreme

Evacuazione

Ricambi



VALVOLE A FARFALLA PVDF
Corpo in PP - GR - VERSIONE LUG
Lente in PVDF
con maniglia

PVDF BUTTERFLY VALVE
Body in PP - GR - LUG STYLE
Disc in PVDF
handle

DN	PN	D	EPDM	€	FPM	€
50	10	63	72392	422,89	72393	526,27
65	10	75	68985	422,89	68992	526,27
80	10	90	68986	586,36	68993	699,01
100	10	110	68987	659,91	68994	814,64
125	10	125-140	68988	870,53	68995	1.083,73
150	10	160	68989	1.253,04	68996	1.497,61
200	10	200-225	68990	1.591,89	68997	2.013,99

C08 | FAM VMA523



VALVOLE A FARFALLA PVDF
Corpo in PP - GR - VERSIONE LUG
Lente in PVDF
a stelo libero

PVDF BUTTERFLY VALVE
Body in PP - GR - LUG STYLE
Disc in PVDF
bare shaft

DN	PN	D	EPDM	€	FPM	€
50	10	63	72394	398,28	72395	501,67
65	10	75	68999	398,28	69008	501,68
80	10	90	69000	560,33	69009	672,99
100	10	110	69001	633,88	69010	788,62
125	10	125-140	69002	841,65	69011	1.054,86
150	10	160	69003	1.224,16	69012	1.468,73
200	10	200-225	69004	1.552,90	69013	1.975,02
250	6	280	69005	2.783,10	69014	3.623,28
300	6	315	69006	3.521,69	69015	4.572,22

* È necessario aggiungere il kit di attuazione per montare un attuatore o un riduttore manuale

* It is needed to add the actuation kit for the assembly of an actuator or gear box

C08 | FAM VMA523



VALVOLE A FARFALLA PVDF
Corpo in PP - GR - VERSIONE LUG
Lente in PVDF
riduttore manuale

PVDF BUTTERFLY VALVE
Body in PP - GR - LUG STYLE
Disc in PVDF
gear box

DN	PN	D	EPDM	€	FPM	€
50	10	63	72396	690,27	72397	793,67
65	10	75	69017	690,27	69026	793,67
80	10	90	69018	853,74	69027	966,39
100	10	110	69019	933,25	69028	1.082,02
125	10	125-140	69020	1.194,49	69029	1.407,68
150	10	160	69021	1.577,00	69030	1.821,57
200	10	200-225	69022	1.920,71	69031	2.342,81
250	6	280	69023	3.320,72	69032	4.160,90
300	6	315	69024	4.069,65	69033	5.120,18

ABS

VALVOLE A FARFALLA ABS SERIE EXTREME - ABS BUTTERFLY VALVE EXTREME SERIES

C08 | FAM VMA524

**VALVOLE A FARFALLA ABS**

Corpo in PP - GR
 Lente in ABS
 con maniglia

ABS BUTTERFLY VALVE

Body in PP - GR
 Disc in ABS
 handle

DN	PN	D	EPDM	€	FPM	€
40	10	50	66750	216,19	66751	298,90
65	10	63-75	62069	270,23	62075	373,63
80	10	90	62070	302,33	62076	414,98
100	10	110	62071	362,93	62077	517,65
125	10	125-140	62072	444,22	62078	657,41
150	10	160	62073	516,23	62079	760,80
200	10	200-225	62074	752,95	62080	1.175,07

C08 | FAM VMA524

**VALVOLE A FARFALLA ABS**

Corpo in PP - GR
 Lente in ABS
 a stelo libero

ABS BUTTERFLY VALVE

Body in PP - GR
 Disc in ABS
 bare shaft

DN	PN	D	EPDM	€	FPM	€
40	10	50	66752	190,60	66753	273,90
65	10	63-75	62081	245,64	62089	349,02
80	10	90	62082	276,30	62090	388,95
100	10	110	62083	336,90	62091	491,64
125	10	125-140	62084	415,33	62092	628,54
150	10	160	62085	487,35	62093	731,92
200	10	200-225	62086	713,98	62094	1.136,09
250	6	250-280	62087	1.317,07	62095	2.157,26
300	6	315	62088	1.704,13	62096	2.754,65

* È necessario aggiungere il kit di attuazione per montare un attuatore o un riduttore manuale

* It is needed to add the actuation kit for the assembly of an actuator or gear box

C08 | FAM VMA524

**VALVOLE A FARFALLA ABS**

Corpo in PP - GR
 Lente in ABS
 riduttore manuale

ABS BUTTERFLY VALVE

Body in PP - GR
 Disc in ABS
 gear box

DN	PN	D	EPDM	€	FPM	€
40	10	50	66754	486,16	66755	568,58
65	10	63-75	62097	537,62	62105	641,01
80	10	90	62098	569,70	62106	682,37
100	10	110	62099	630,32	62107	785,04
125	10	125-140	62100	768,17	62108	981,36
150	10	160	62101	840,19	62109	965,91
200	10	200-225	62102	1.081,78	62110	1.503,89
250	6	250-280	62103	1.854,70	62111	2.694,88
300	6	315	62104	2.252,09	62112	3.302,62

ABS

VALVOLE A FARFALLA ABS SERIE EXTREME VERSIONE LUG - ABS BUTTERFLY VALVE EXTREME SERIES LUG STYLE

C08 | FAM VMA525

Accessori PVC-U

Valvole PVC-U

Accessori PVC-C

Valvole PVC-C

Valvole Extreme

Evacuazione

Ricambi



VALVOLE A FARFALLA ABS

Corpo in PP - GR - VERSIONE LUG
Lente in ABS
con maniglia

ABS BUTTERFLY VALVE

Body in PP - GR - LUG STYLE
Disc in ABS
handle

DN	PN	D	EPDM	€	FPM	€
50	10	63	72398	412,78	72399	516,17
65	10	75	69035	412,78	69045	516,18
80	10	90	69036	572,45	69047	685,11
100	10	110	69037	631,75	69048	786,47
125	10	125-140	69038	810,40	69049	1.023,60
150	10	160	69039	1.165,58	69051	1.410,15
200	10	200-225	69040	1.389,38	69055	1.811,50

C08 | FAM VMA524



VALVOLE A FARFALLA ABS

Corpo in PP - GR - VERSIONE LUG
Lente in ABS
a stelo libero

ABS BUTTERFLY VALVE

Body in PP - GR - LUG STYLE
Disc in ABS
bare shaft

DN	PN	D	EPDM	€	FPM	€
50	10	63	72400	388,19	72401	491,39
65	10	75	69057	388,19	69066	491,57
80	10	90	69058	546,43	69067	659,08
100	10	110	69059	605,72	69068	760,46
125	10	125-140	69060	781,52	69069	994,72
150	10	160	69061	1.136,71	69070	1.381,28
200	10	200-225	69062	1.350,40	69071	1.772,52
250	6	280	69063	2.312,38	69072	3.152,56
300	6	315	69064	2.730,23	69073	3.780,76

* È necessario aggiungere il kit di attuazione per montare un attuatore o un riduttore manuale

* It is needed to add the actuation kit for the assembly of an actuator or gear box

C08 | FAM VMA524



VALVOLE A FARFALLA ABS

Corpo in PP - GR - VERSIONE LUG
Lente in ABS
riduttore manuale

ABS BUTTERFLY VALVE

Body in PP - GR - LUG STYLE
Disc in ABS
gear box

DN	PN	D	EPDM	€	FPM	€
50	10	63	72402	680,17	72403	783,56
65	10	75	69075	680,17	69084	783,56
80	10	90	69076	839,83	69085	952,49
100	10	110	69077	899,14	69086	1.053,86
125	10	125-140	69078	1.134,35	69087	1.347,55
150	10	160	69079	1.489,53	69088	1.615,27
200	10	200-225	69080	1.718,21	69089	2.140,32
250	6	280	69081	2.850,01	69090	3.690,18
300	6	315	69082	3.278,19	69091	4.328,72

ACCESSORI VALVOLE MANUALI - ACCESSORIES MANUAL VALVES

C08

**SISTEMA DI BLOCCO**

per valvole a sfera manuali Serie Extreme.

Sistema di blocco in acciaio inossidabile funge da meccanismo di sicurezza APERTO/CHIUSO (con possibilità di chiusura con lucchetto).

Il kit è venduto separatamente dalla valvola.

LOCKING DEVICE KIT

for ball valve Extreme Series

Stainless steel kit to install easily in the handle of a manual ball valve to act as a security device OPEN/CLOSE (possibility of a padlock closing).

Sold as separate kit.

DN	D	CODE	€
10	16 - 3/8"	66487	31,49
15	20 - 1/2"	66487	31,49
20	25 - 3/4"	66488	34,62
25	32 - 1"	66489	37,77
32	40 - 1 1/4"	66490	40,91
40	50 - 1 1/2"	66491	44,05
50	63 - 2"	66492	50,33

C08

**KIT SENSORE INDUTTIVO PER RILEVAMENTO DI POSIZIONE**

per valvole a sfera manuali Serie Extreme.

Sistema di montaggio e trasmettitori induttivi per la visualizzazione elettronica a distanza della posizione della valvola a sfera (APERTA/CHIUSA).

Il kit è venduto separatamente dalla valvola (aggiungere LI dopo il codice della valvola).

INDUCTIVE POSITION INDICATOR

for ball manual valve Extreme Series.

Coupling kit and inductive transmitters for the remote electronic visualization of the valve position (OPEN/CLOSE).

Sold as an option upon request (add LI after the valve code).

DN	D	CODE	€
10	16 - 3/8"	LI	Consultare
15	20 - 1/2"	LI	Consultare
20	25 - 3/4"	LI	Consultare
25	32 - 1"	LI	Consultare
32	40 - 1 1/4"	LI	Consultare
40	50 - 1 1/2"	LI	Consultare
50	63 - 2"	LI	Consultare

C08

**BOX FINECORSA**

per valvole a sfera manuali Serie Extreme.

Configurazione con possibilità d'impostazione finecorsa per la visualizzazione in remoto della posizione della valvola a sfera (APERTA/CHIUSA).

Disponibile per i diametri DN50-DN100. Il box finecorsa viene venduto separatamente dalla valvola (non come kit) (aggiungere LE dopo il codice della valvola).

LIMIT SWITCH BOX

for ball valve Extreme Series

Special configuration with mechanical limit switch box in a manual ball valve for the remote electronic visualization of the valve position (open/close).

Available for sizes DN50-DN100. Sold only complete valve configuration (not as a kit) (add LE after the valve code).

DN	D	CODE	€
50	63	LE	Consultare
65	75	LE	Consultare
80	90	LE	Consultare
100	110	LE	Consultare

ACCESSORI VALVOLE MANUALI - ACCESSORIES MANUAL VALVES

C08

Accessori PVC-U

Valvole PVC-U

Accessori PVC-C

Valvole PVC-C

Valvole Extreme

Evacuazione

Ricambi



BOX FINECORSA

per valvole a farfalla con comando manuale Serie Extreme.

Configurazione con possibilità d'impostazione finecorsa per la visualizzazione in remoto della posizione della valvola a farfalla (APERTA/CHIUSA). Disponibile per i diametri DN40-DN200. Il box finecorsa viene venduto separatamente dalla valvola (non come kit) (aggiungere LE dopo il codice della valvola).

LIMIT SWITCH BOX

for butterfly valve Extreme Series

Special configuration with mechanical limit switch box in a manual butterfly valve (with handle) for the remote electronic visualization of the valve position (open/close).

Available for sizes DN40-DN200. Sold only complete valve configuration (not as a kit) (add LE after the valve code).

DN	D	CODE	€
40	50	LE	Consultare
65	63-75	LE	Consultare
80	90	LE	Consultare
100	110	LE	Consultare
125	125-140	LE	Consultare
150	160	LE	Consultare
200	200-225	LE	Consultare

C08



BOX FINECORSA

per valvole a farfalla con riduttore manuale Serie Extreme.

Configurazione con possibilità d'impostazione finecorsa per la visualizzazione in remoto della posizione della valvola a farfalla (APERTA/CHIUSA).

Disponibile per i diametri DN40-DN300. Il box finecorsa viene venduto separatamente dalla valvola (non come kit).

I seguenti codici contengono il riduttore manuale + box finecorsa (aggiungere LF dopo il codice della valvola).

LIMIT SWITCH BOX

for butterfly valve Extreme Series

Special configuration with mechanical limit switch box in a manual butterfly valve (with gear box) for the remote electronic visualization of the valve position (open/close).

Available for sizes DN40-DN300. Sold only complete valve configuration (not as a kit).

Price of the gear box + limit switch box to apply on a bare shaft valve (add LF after the valve code).

DN	D	CODE	€
40	50	LF	Consultare
65	63-75	LF	Consultare
80	90	LF	Consultare
100	110	LF	Consultare
125	125-140	LF	Consultare
150	160	LF	Consultare
200	200-225	LF	Consultare
250	250	LF	Consultare
300	315	LF	Consultare

**VALVOLE
INDUSTRIALI
ATTUATE
CEPEX EXTREME**

**CEPEX EXTREME INDUSTRIAL
ACTUATED VALVE**

Accessori PVC-U

Valvole PVC-U

Accessori PVC-C

Valvole PVC-C

Valvole Extreme

Evacuazione

Ricambi

VALVOLE A SFERA ATTUATE
ACTUATED BALL VALVES

143 Valvole a sfera PVC-U
PVC-U ball valves



152 Valvole a sfera PVC-C
CPVC ball valves



158 Valvole a sfera PP-H
PP-H ball valves



167 Valvole a sfera PVDF
PVDF ball valves



173 Valvole a sfera ABS
ABS ball valves



VALVOLE A FARFALLA ATTUATE
ACTUATED BUTTERFLY VALVES

179 Valvole a farfalla PVC-U
PVC-U butterfly valves



180 Valvole a farfalla PVC-C
CPVC butterfly valves



181 Valvole a farfalla PP-H
PP-H butterfly valves



182 Valvole a farfalla PVDF
PVDF butterfly valves



183 Valvole a farfalla ABS
ABS butterfly valves







ACCESSORI
ACCESSORIES

184 Accessori
Accessories

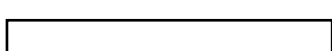

LEGENDA MATERIALI
MATERIALS LEGEND

	PVC-U
	PVC-C
	PP-H
	PVDF
	ABS

VALVOLE A SFERA CON ATTUAZIONE PNEUMATICA BALL VALVES WITH PNEUMATIC ACTUATION



Attuazione pneumatica per tutte le valvole a sfera Serie Extreme.

Modello base: Rotork modello GT.

Possibilità di configurazione con altri modelli e marchi. Può essere impiegato anche come dispositivo singolo per l'esercizio di altri organi di regolazione da parte del cliente.

Opzioni di attuazione:

- SEMPLICE EFFETTO con valvola normalmente chiusa (SE - NC).
- SEMPLICE EFFETTO con valvola normalmente aperta (SE - NA).
- DOPPIO EFFETTO (DA).

Accessori opzionali:

- Box finecorsa.
- Elettrovalvola di comando (in differenti configurazioni).
- Silenziatore di sfato aria.

Pneumatic actuation possibility in all versions of the ball valve Extreme Series.

Default actuator: Rotork model GT

Possibility of actuation using other brands or models, or preparing the valve for customer own actuation.

Actuation options

- Spring return with normally closed valve (NC).
- Spring return with normally open valve (NO).
- Double acting (DA).

Optional accessories

- Limit switch box.
- Solenoid valve (different configurations).
- Relief regulator.

Rotork GT - Caratteristiche standard:

- Attuatore a pistone.
- Design leggero e compatto.
- Corpo in alluminio anodizzato.
- Garantisce nel lungo periodo la massima efficienza ed una manutenzione minima.

Rotork GT - Actuator characteristics:

- Piston drive.
- Compact design and lightweight.
- Housed in anodised aluminium.
- Long and efficient service with a minimum maintenance.



VALVOLE A SFERA CON ATTUAZIONE ELETTRICA BALL VALVES WITH ELECTRIC ACTUATION



Attuazione elettrica per tutte le versioni di valvole a sfera Serie Extreme.

Modello base: J+J.

Possibilità di configurazione con altri modelli e marchi. Può essere impiegato anche come dispositivo singolo per l'esercizio di altri organi di regolazione da parte del cliente.

Opzioni di attuazione

- Basso voltaggio (24 VAC / VDC).
- Alto voltaggio (80-240 VAC / VDC).
- Multivoltaggio (24-240 VAC/VDC) in alcuni modelli (DN40-DN100).

Accessori opzionali

- BSR - Blocco di sicurezza.
- DPS - Posizionatore digitale.

Electric actuation possibility in all versions of the ball valve Extreme Series.

Default actuator - J+J

Possibility of actuation using other brands or models, or preparing the valve for customer own actuation.

Actuation options

- Low voltage (24 VAC / VDC).
- High voltage (80-240 VAC / VDC).
- Multivoltage (24-240 VAC/VDC) in some models (DN40-DN100).

Optional accessories

- BSR - Safety block.
- DPS - Digital positioner.

J+J - Caratteristiche standard:

- Controllo elettronico della rotazione con limitatore di coppia.
- Resistenza interna anticondensa.
- Selettore automatico/manuale, con comando manuale di emergenza.
- Segnalatore di apertura e chiusura tramite contatto pulito (libero da tensione).
- Indicatore a LED delle operazioni/errori di segnalazione.
- Corpo esterno in poliammide anticorrosiva.

Actuator characteristics J+J:

- Electronic torque control, with limitation of maximum torque
- Anti-condensation heating resistor
- Automatic / manual lever, with manual override
- Open and closed volt free contacts
- Indicator LED operating / error
- Enclosure in anticorrosive polyamide



KIT DI ATTUAZIONE ACTUATION KIT

Alfanum. | C08

Il kit include tutti gli elementi necessari per la connessione tra la valvola a sfera e l'attuatore ed è compatibile con i modelli di altre marche certificati dalla normativa ISO 5211.

Componenti: bussola di connessione, bulloneria e supporto di fissaggio.

The kit includes all the necessary elements to connect the ball valve with the actuator and it is ready for all the brands of actuators following the ISO 5211 regulation.

Components: coupling bush, supports, bolts, mounting clamp and connectors.

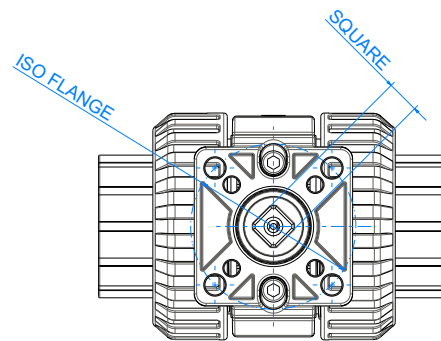
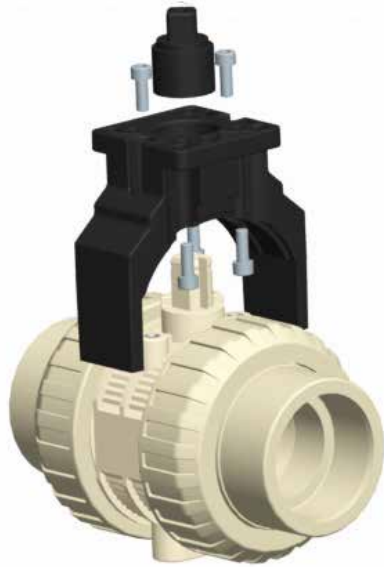

D	DN	ISO FLANGE F03			ISO FLANGE F04			ISO FLANGE F05				ISO FLANGE F07		
		Q9	Q11	Q14	Q9	Q11	Q14	Q9	Q11	Q14	Q17	Q11	Q14	Q17
20	15	65396	65397	65398	65881	65882	65883	65399	65400	65401				
		21,18 €	21,18 €	21,18 €	21,18 €	21,18 €	21,18 €	21,18 €	21,18 €	21,18 €	21,18 €			
25	20	65884	65885	65886	65887	65888	65889	65402	65403	65404				
		21,18 €	21,18 €	21,18 €	21,18 €	21,18 €	21,18 €	21,18 €	21,18 €	21,18 €	21,18 €			
32	25								65405	65406				
									22,54 €	22,54 €				
40	32								65407	65408				
									22,54 €	22,54 €				
50	40								65409	65410	65411	65412	65413	65414
									23,70 €	23,70 €	23,70 €	23,70 €	23,70 €	23,70 €
63	50								65415	65416	65417	65418	65419	65420
									23,70 €	23,70 €	23,70 €	23,70 €	23,70 €	23,70 €

PVC-U / CPVC / ABS

D	DN	ISO FLANGE F07		ISO FLANGE F10	
		Q17	Q22	Q17	Q22
75	65	65421			
		25,64 €			
90	80	65422	65423		
		25,64 €	25,64 €		
110	100	69503	69504	69505	69506
		47,29 €	47,29 €	47,29 €	47,29 €

PP-H / PVDF

D	DN	ISO FLANGE F07		ISO FLANGE F10	
		Q17	Q22	Q17	Q22
75	65	71875			
		25,64 €			
90	80	69341	69342		
		25,64 €	25,64 €		
110	100	72287	69569	72288	72289
		47,29 €	47,29 €	47,29 €	47,29 €

PVC-U

VALVOLE A SFERA PVC-U SERIE EXTREME - ATTUATORE PNEUMATICO SEMPLICE EFFETTO (NC)
PVC-U BALL VALVE EXTREME SERIES - PNEUMATIC ACTUATOR SPRING RETURN (NC)

rotork

C08 | FAM VAL385

Accessori PVC-U

Valvole PVC-U

Accessori PVC-C

Valvole PVC-C

Valvole Extreme

Evacuazione

Ricambi

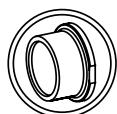

VALVOLE A SFERA PVC-U
incollaggio femmina ISO/DIN

PVC-U BALL VALVE
solvent socket ISO/DIN



DN	PN	D	EPDM	€	FPM	€
10	16	16	6458305R	403,98	6466805R	415,86
15	16	20	6458405R	403,98	6466905R	415,86
20	16	25	6458505R	420,23	6467005R	434,14
25	16	32	6458605R	440,59	6467105R	459,60
32	16	40	6458705R	465,78	6467205R	489,55
40	16	50	6458805R	597,15	6467305R	625,66
50	16	63	6458905R	729,70	6467405R	774,86
65	10	75	6459005R	1.288,99	6467505R	1.362,67
80	10	90	6459105R	1.527,40	6467605R	1.617,72
100	10	110	6459205R	1.634,89	6467705R	1.732,76

C08 | FAM VAL385

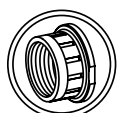

VALVOLE A SFERA PVC-U
filetto femmina BSP
rinforzo in acciaio inossidabile

PVC-U BALL VALVE
female thread BSP
Stainless steel reinforcement



DN	PN	G	EPDM	€	FPM	€
10	16	3/8"	6460205R	411,94	6467805R	423,82
15	16	1/2"	6460305R	411,94	6467905R	423,82
20	16	3/4"	6460405R	428,55	6468005R	442,46
25	16	1"	6460505R	450,57	6468105R	469,58
32	16	1 1/4"	6460605R	477,43	6468205R	501,19
40	16	1 1/2"	6460705R	611,77	6468305R	640,28
50	16	2"	6460805R	746,58	6468405R	791,74
65	10	2 1/2"	6460905R	1.309,67	6468505R	1.383,34
80	10	3"	6461005R	1.550,81	6468605R	1.641,13
100	10	4"	6461105R	1.667,61	6468705R	1.765,48

C08 | FAM VAL385

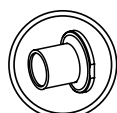

VALVOLE A SFERA PVC-U
incollaggio maschio ISO/DIN

PVC-U BALL VALVE
male solvent socket ISO/DIN



DN	PN	D	EPDM	€	FPM	€
10	16	16	6686805R	408,37	6741305R	420,25
15	16	20	6686905R	408,37	6741405R	420,25
20	16	25	6687005R	425,46	6741505R	439,37
25	16	32	6687105R	448,79	6741605R	467,80
32	16	40	6687205R	474,09	6741705R	497,86
40	16	50	6687305R	608,20	6741805R	636,71
50	16	63	6687405R	739,91	6741905R	785,07
65	10	75	6742805R	1.310,26	6743005R	1.383,94
80	10	90	6742905R	1.556,40	6743105R	1.646,72
100	10	110	6855405R	1.675,16	6855505R	1.773,02

Per attuatori SE - NA, Consultare

For SR - NO actuator, ask for the code

VALVOLE A SFERA PVC-U SERIE EXTREME - ATTUATORE PNEUMATICO SEMPLICE EFFETTO (NC)
PVC-U BALL VALVE EXTREME SERIES - PNEUMATIC ACTUATOR SPRING RETURN (NC)
rotork

C08 | FAM VAL385

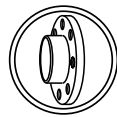
VALVOLE A SFERA PVC-U
 flange ISO in PVC-U
 flangia libera (RF)

PVC-U BALL VALVE
 PVC-U ISO flanges
 loose flange (RF)

DN	PN	D	EPDM	€	FPM	€
15	16	20	6461305R	416,58	6503105R	428,46
20	16	25	6461405R	434,26	6503205R	448,16
25	16	32	6461505R	456,27	6503305R	475,29
32	16	40	6461605R	483,13	6503405R	506,90
40	16	50	6461705R	621,86	6503505R	650,39
50	16	63	6461805R	759,41	6503605R	804,33
65	10	75	6461905R	1.337,01	6503705R	1.410,68
80	10	90	6462005R	1.581,12	6503805R	1.671,43
100	10	110	6463205R	1.690,84	6503905R	1.788,70

C08 | FAM VAL385

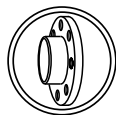
VALVOLE A SFERA PVC-U
 flange ISO in PVC-U
 flangia fissa (FF)

PVC-U BALL VALVE
 PVC-U ISO flanges
 fixed flange (FF)

DN	PN	D	EPDM	€	FPM	€
15	16	20	7220805R	Consultare	7221405R	Consultare
20	16	25	7220905R	Consultare	7221505R	Consultare
25	16	32	7221005R	Consultare	7221605R	Consultare
32	16	40	7221105R	Consultare	7221705R	Consultare
40	16	50	7221205R	Consultare	7221805R	Consultare
50	16	63	7221305R	Consultare	7221905R	Consultare
65	10	75	7222805R	Consultare	7223105R	Consultare
80	10	90	7222905R	Consultare	7223205R	Consultare
100	10	110	7223005R	Consultare	7223305R	Consultare

C08 | FAM VAL385

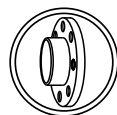
VALVOLE A SFERA PVC-U
 flange ANSI-150 in PVC-U
 flangia fissa (FF)

PVC-U BALL VALVE
 PVC-U ANSI-150 flanges
 fixed flange (FF)

DN	PN	D	EPDM	€	FPM	€
15	16	½"	72208AB05R	439,24	72214AB05R	453,02
20	16	¾"	72209AB05R	459,62	72215AB05R	475,74
25	16	1"	72210AB05R	473,38	72216AB05R	496,52
32	16	1¼"	72211AB05R	503,89	72217AB05R	532,81
40	16	1½"	72212AB05R	648,14	72218AB05R	682,84
50	16	2"	72213AB05R	791,09	72219AB05R	845,74
65	10	2½"	72228AB05R	1.405,42	72231AB05R	1.495,07
80	10	3"	72229AB05R	1.660,00	72232AB05R	1.769,90
100	10	4"	72230AB05R	1.815,50	72233AB05R	1.912,57

PVC-U

VALVOLE A SFERA PVC-U SERIE EXTREME - ATTUATORE PNEUMATICO SEMPLICE EFFETTO (NC)
PVC-U BALL VALVE EXTREME SERIES - PNEUMATIC ACTUATOR SPRING RETURN (NC)

rotork
C08 | FAM VAL385

Accessori PVC-U

Valvole PVC-U

Accessori PVC-C

Valvole PVC-C

Valvole Extreme

Evacuazione

Ricambi

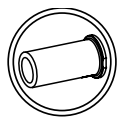

VALVOLE A SFERA PVC-U
saldatura testa a testa
PE100 / SDR11

PVC-U BALL VALVE
butt welding
PE100 / SDR11

DN	PN	D	EPDM	€	FPM	€
15	16	20	6465905R	408,38	6513405R	420,26
20	16	25	6466005R	425,46	6513505R	439,36
25	16	32	6466105R	448,79	6513605R	467,80
32	16	40	6466205R	474,09	6513805R	497,86
40	16	50	6466305R	608,20	6514105R	636,71
50	16	63	6466405R	739,92	6514205R	785,08
65	10	75	6466505R	1.310,26	6514305R	1.383,94
80	10	90	6466605R	1.556,40	6514405R	1.646,72
100	10	110	6466705R	1.675,19	6514505R	1.773,02

VALVOLE A SFERA PVC-U SERIE EXTREME - ATTUATORE PNEUMATICO DOPPIO EFFETTO
PVC-U BALL VALVE EXTREME SERIES - PNEUMATIC ACTUATOR DOUBLE ACTING

C08 | FAM VAL385

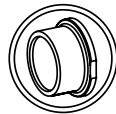
VALVOLE A SFERA PVC-U
 incollaggio femmina ISO/DIN

PVC-U BALL VALVE
 solvent socket ISO/DIN

DN	PN	D	EPDM	€	FPM	€
10	16	16	6458307R	370,99	6466807R	382,87
15	16	20	6458407R	370,99	6466907R	382,87
20	16	25	6458507R	378,49	6467007R	392,40
25	16	32	6458607R	383,86	6467107R	402,88
32	16	40	6458707R	390,92	6467207R	414,69
40	16	50	6458807R	401,05	6467307R	429,57
50	16	63	6458907R	427,83	6467407R	472,99
65	10	75	6459007R	741,65	6467507R	815,32
80	10	90	6459107R	807,60	6467607R	897,91
100	10	110	6459207R	915,09	6467707R	1.012,95

C08 | FAM VAL385

VALVOLE A SFERA PVC-U
 filetto femmina BSP
 rinforzo in acciaio inossidabile

PVC-U BALL VALVE
 female thread BSP
 Stainless steel reinforcement

DN	PN	G	EPDM	€	FPM	€
10	16	3/8"	6460207R	378,95	6467807R	390,84
15	16	1/2"	6460307R	378,95	6467907R	390,84
20	16	3/4"	6460407R	386,81	6468007R	400,72
25	16	1"	6460507R	393,85	6468107R	412,86
32	16	1 1/4"	6460607R	402,57	6468207R	426,33
40	16	1 1/2"	6460707R	415,67	6468307R	444,18
50	16	2"	6460807R	444,70	6468407R	489,86
65	10	2 1/2"	6460907R	762,32	6468507R	836,01
80	10	3"	6461007R	831,01	6468607R	921,33
100	10	4"	6461107R	947,81	6468707R	1.045,67

C08 | FAM VAL385

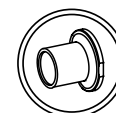
VALVOLE A SFERA PVC-U
 incollaggio maschio ISO/DIN

PVC-U BALL VALVE
 male solvent socket ISO/DIN

DN	PN	D	EPDM	€	FPM	€
10	16	16	6686807R	375,38	6741307R	387,27
15	16	20	6686907R	375,38	6741407R	387,27
20	16	25	6687007R	383,72	6741507R	397,63
25	16	32	6687107R	392,06	6741607R	411,08
32	16	40	6687207R	399,24	6741707R	423,01
40	16	50	6687307R	412,10	6741807R	440,63
50	16	63	6687407R	438,04	6741907R	483,20
65	10	75	6742807R	762,92	6743007R	836,60
80	10	90	6742907R	836,60	6743107R	926,91
100	10	110	6855407R	955,35	6855507R	1.053,23

PVC-U

VALVOLE A SFERA PVC-U SERIE EXTREME - ATTUATORE PNEUMATICO DOPPIO EFFETTO
PVC-U BALL VALVE EXTREME SERIES - PNEUMATIC ACTUATOR DOUBLE ACTING

rotork

C08 | FAM VAL385

Accessori PVC-U

Valvole PVC-U

Accessori PVC-C

Valvole PVC-C

Valvole Extreme

Evacuazione

Ricambi

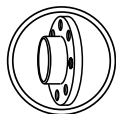

VALVOLE A SFERA PVC-U
flange ISO in PVC-U
flangia libera (RF)

PVC-U BALL VALVE
PVC-U ISO flanges
loose flange (RF)



DN	PN	D	EPDM	€	FPM	€
15	16	20	6461307R	383,59	6503107R	395,48
20	16	25	6461407R	392,52	6503207R	406,42
25	16	32	6461507R	399,55	6503307R	418,57
32	16	40	6461607R	408,27	6503407R	432,04
40	16	50	6461707R	425,76	6503507R	454,29
50	16	63	6461807R	457,54	6503607R	502,46
65	10	75	6461907R	789,66	6503707R	863,33
80	10	90	6462007R	861,32	6503807R	951,64
100	10	110	6463207R	971,04	6503907R	1.068,90

C08 | FAM VAL385

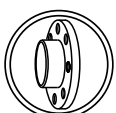

VALVOLE A SFERA PVC-U
flange ISO in PVC-U
flangia fissa (FF)

PVC-U BALL VALVE
PVC-U ISO flanges
fixed flange (FF)



DN	PN	D	EPDM	€	FPM	€
15	16	20	7220807R	Consultare	7221407R	Consultare
20	16	25	7220907R	Consultare	7221507R	Consultare
25	16	32	7221007R	Consultare	7221607R	Consultare
32	16	40	7221107R	Consultare	7221707R	Consultare
40	16	50	7221207R	Consultare	7221807R	Consultare
50	16	63	7221307R	Consultare	7221907R	Consultare
65	10	75	7222807R	Consultare	7223107R	Consultare
80	10	90	7222907R	Consultare	7223207R	Consultare
100	10	110	7223007R	Consultare	7223307R	Consultare

C08 | FAM VAL385

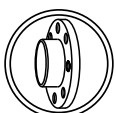

VALVOLE A SFERA PVC-U
flange ANSI-150 in PVC-U
flangia fissa (FF)

PVC-U BALL VALVE
PVC-U ANSI-150 flanges
fixed flange (FF)



DN	PN	D	EPDM	€	FPM	€
15	16	½"	72208AB07R	406,26	72214AB07R	420,03
20	16	¾"	72209AB07R	417,88	72215AB07R	434,00
25	16	1"	72210AB07R	416,64	72216AB07R	439,79
32	16	1¼"	72211AB07R	429,04	72217AB07R	457,96
40	16	1½"	72212AB07R	452,04	72218AB07R	486,74
50	16	2"	72213AB07R	489,22	72219AB07R	543,87
65	10	2½"	72228AB07R	858,08	72231AB07R	947,73
80	10	3"	72229AB07R	940,19	72232AB07R	1.050,09
100	10	4"	72230AB07R	1.095,70	72233AB07R	1.192,78

VALVOLE A SFERA PVC-U SERIE EXTREME - ATTUATORE PNEUMATICO DOPPIO EFFETTO
PVC-U BALL VALVE EXTREME SERIES - PNEUMATIC ACTUATOR DOUBLE ACTING

C08 | FAM VAL385

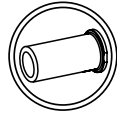
VALVOLE A SFERA PVC-U
 saldatura testa a testa
 PE100 / SDR11

PVC-U BALL VALVE
 butt welding
 PE100 / SDR11

DN	PN	D	EPDM	€	FPM	€
15	16	20	6465907R	375,39	6513407R	387,27
20	16	25	6466007R	383,72	6513507R	397,63
25	16	32	6466107R	392,07	6513607R	411,08
32	16	40	6466207R	399,24	6513807R	423,01
40	16	50	6466307R	412,10	6514107R	440,63
50	16	63	6466407R	438,04	6514207R	483,20
65	10	75	6466507R	762,92	6514307R	836,60
80	10	90	6466607R	836,60	6514407R	926,91
100	10	110	6466707R	955,39	6514507R	1.053,23

PVC-U

VALVOLE A SFERA PVC-U SERIE EXTREME - ATTUATORE ELETTRICO 85-240V AC/DC
PVC-U BALL VALVE EXTREME SERIES - ELECTRIC ACTUATOR 85-240V AC/DC

J+J

C08 | FAM VAL375



VALVOLE A SFERA PVC-U
incollaggio femmina ISO/DIN

PVC-U BALL VALVE
metric solvent socket ISO/DIN



DN	PN	D	EPDM		€	FPM		€
			85-240V	24V		85-240V	24V	
10	16	16	6458309J	6458310J	556,37	6466809J	6466810J	568,26
15	16	20	6458409J	6458410J	556,37	6466909J	6466910J	568,26
20	16	25	6458509J	6458510J	560,60	6467009J	6467010J	574,50
25	16	32	6458609J	6458610J	569,34	6467109J	6467110J	588,36
32	16	40	6458709J	6458710J	576,66	6467209J	6467210J	600,43
40	16	50	6458809J *		765,93	6467309J *		794,45
50	16	63	6458909J *		828,02	6467409J *		873,18
65	10	75	6459009J *		1.068,79	6467509J *		1.142,46
80	10	90	6459109J *		1.355,62	6467609J *		1.445,94
100	10	110	6459209J *		1.851,95	6467709J *		1.949,81

C08 | FAM VAL375



VALVOLE A SFERA PVC-U
filetto femmina BSP
rinforzo in acciaio inossidabile

PVC-U BALL VALVE
female thread BSP
Stainless steel reinforcement



DN	PN	G	EPDM		€	FPM		€
			85-240V	24V		85-240V	24V	
10	16	3/8"	6460209J	6460210J	564,34	6467809J	6467810J	576,22
15	16	1/2"	6460309J	6460310J	564,34	6467909J	6467910J	576,22
20	16	3/4"	6460409J	6460410J	568,92	6468009J	6468010J	582,82
25	16	1"	6460509J	6460510J	579,33	6468109J	6468110J	598,34
32	16	1 1/4"	6460609J	6460610J	588,31	6468209J	6468210J	612,07
40	16	1 1/2"	6460709J *		780,55	6468309J *		809,06
50	16	2"	6460809J *		844,89	6468409J *		890,05
65	10	2 1/2"	6460909J *		1.089,47	6468509J *		1.163,14
80	10	3"	6461009J *		1.379,04	6468609J *		1.469,35
100	10	4"	6461109J *		1.884,66	6468709J *		1.982,53

C08 | FAM VAL375



VALVOLE A SFERA PVC-U
incollaggio maschio ISO/DIN

PVC-U BALL VALVE
male solvent socket ISO/DIN



DN	PN	D	EPDM		€	FPM		€
			85-240V	24V		85-240V	24V	
10	16	16	6686809J	6686810J	560,77	6741309J	6741310J	572,65
15	16	20	6686909J	6686910J	560,77	6741409J	6741410J	572,65
20	16	25	6687009J	6687010J	565,82	6741509J	6741510J	579,73
25	16	32	6687109J	6687110J	577,54	6741609J	6741610J	596,56
32	16	40	6687209J	6687210J	584,97	6741709J	6741710J	608,74
40	16	50	6687309J *		776,98	6741809J *		805,51
50	16	63	6687409J *		838,23	6741909J *		883,39
65	10	75	6742809J *		1.090,06	6743009J *		1.163,73
80	10	90	6742909J *		1.384,62	6743109J *		1.474,94
100	10	110	6855409J *		1.892,21	6855509J *		1.990,07

* Multivoltaggio 24-240V AC/DC

* Multivoltage 24-240V AC/DC

Accessori PVC-U

Valvole PVC-U

Accessori PVC-C

Valvole PVC-C

Valvole Extreme

Evacuazione

Ricambi

VALVOLE A SFERA PVC-U SERIE EXTREME - ATTUATORE ELETTRICO 85-240V AC/DC
PVC-U BALL VALVE EXTREME SERIES - ELECTRIC ACTUATOR 85-240V AC/DC

C08 | FAM VAL375

VALVOLE A SFERA PVC-U
 flange ISO in PVC-U
 flangia libera (RF)

PVC-U BALL VALVE
 PVC-U ISO flanges
 loose flange (RF)

DN	PN	D	EPDM		€	FPM		€
			85-240V	24V		85-240V	24V	
15	16	20	6461309J	6461310J	568,96	6503109J	6503110J	580,85
20	16	25	6461409J	6461410J	574,62	6503209J	6503210J	588,52
25	16	32	6461509J	6461510J	585,03	6503309J	6503310J	604,05
32	16	40	6461609J	6461610J	594,01	6503409J	6503410J	617,78
40	16	50	6461709J *		790,64	6503509J *		819,17
50	16	63	6461809J *		857,73	6503609J *		902,65
65	10	75	6461909J *		1.116,80	6503709J *		1.190,47
80	10	90	6462009J *		1.409,34	6503809J *		1.499,66
100	10	110	6463209J *		1.907,89	6503909J *		2.005,76

C08 | FAM VAL375

VALVOLE A SFERA PVC-U
 flange ISO in PVC-U
 flangia fissa (FF)

PVC-U BALL VALVE
 PVC-U ISO flanges
 fixed flange (FF)

DN	PN	D	EPDM		€	FPM		€
			85-240V	24V		85-240V	24V	
15	16	20	7220809J	7220810J	Consultare	7221409J	7221410J	Consultare
20	16	25	7220909J	7220910J	Consultare	7221509J	7221510J	Consultare
25	16	32	7221009J	7221010J	Consultare	7221609J	7221610J	Consultare
32	16	40	7221109J	7221110J	Consultare	7221709J	7221710J	Consultare
40	16	50	7221209J *		Consultare	7221809J *		Consultare
50	16	63	7221309J *		Consultare	7221909J *		Consultare
65	10	75	7222809J *		Consultare	7223109J *		Consultare
80	10	90	7222909J *		Consultare	7223209J *		Consultare
100	10	110	7223009J *		Consultare	7223309J *		Consultare

C08 | FAM VAL375

VALVOLE A SFERA PVC-U
 flange ANSI-150 in PVC-U
 flangia fissa (FF)

PVC-U BALL VALVE
 PVC-U ANSI-150 flanges
 fixed flange (FF)

DN	PN	D	EPDM		€	FPM		€
			85-240V	24V		85-240V	24V	
15	16	½"	72208AB09J	72208AB10J	591,64	72214AB09J	72214AB10J	605,42
20	16	¾"	72209AB09J	72209AB10J	599,99	72215AB09J	72215AB10J	616,11
25	16	1"	72210AB09J	72210AB10J	602,12	72216AB09J	72216AB10J	625,27
32	16	1¼"	72211AB09J	72211AB10J	614,77	72217AB09J	72217AB10J	643,70
40	16	1½"	72212AB09J *		816,92	72218AB09J *		851,62
50	16	2"	72213AB09J *		889,42	72219AB09J *		944,07
65	10	2½"	72228AB09J *		1.185,22	72231AB09J *		1.274,87
80	10	3"	72229AB09J *		1.488,22	72232AB09J *		1.598,11
100	10	4"	72230AB09J *		2.032,56	72233AB09J *		2.129,63

* Multivoltaggio 24-240V AC/DC

* Multivoltage 24-240V AC/DC

PVC-U

VALVOLE A SFERA PVC-U SERIE EXTREME - ATTUATORE ELETTRICO 85-240V AC/DC
PVC-U BALL VALVE EXTREME SERIES - ELECTRIC ACTUATOR 85-240V AC/DC

J+J

C08 | FAM VAL375



VALVOLE A SFERA PVC-U

saldatura testa a testa
PE100 / SDR11

PVC-U BALL VALVE

butt welding
PE100 / SDR11



DN	PN	D	EPDM		€	FPM		€
			85-240V	24V		85-240V	24V	
15	16	20	6465909J	6465910J	560,77	6513409J	6513410J	572,65
20	16	25	6466009J	6466010J	565,82	6513509J	6513510J	579,73
25	16	32	6466109J	6466110J	577,55	6513609J	6513610J	596,56
32	16	40	6466209J	6466210J	584,97	6513809J	6513810J	608,74
40	16	50	6466309J *		776,98	6514109J *		805,51
50	16	63	6466409J *		838,23	6514209J *		883,39
65	10	75	6466509J *		1.090,06	6514309J *		1.163,73
80	10	90	6466609J *		1.384,62	6514409J *		1.474,94
100	10	110	6466709J *		1.892,24	6514509J *		1.990,07

Accessori PVC-U

Valvole PVC-U

Accessori PVC-C

Valvole PVC-C

Valvole Extreme

Evacuazione

Ricambi

PVC-C

VALVOLE A SFERA PVC-C SERIE EXTREME - ATTUATORE PNEUMATICO SEMPLICE EFFETTO (NC)
CPVC BALL VALVE EXTREME SERIES - PNEUMATIC ACTUATOR SPRING RETURN (NC)

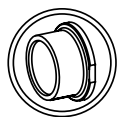

C08 | FAM VAL385

VALVOLE A SFERA PVC-C
 incollaggio femmina ISO/DIN

CPVC BALL VALVE
 metric solvent socket ISO/DIN

DN	PN	D	EPDM	€	FPM	€
10	16	16	6486405R	418,24	6487505R	430,12
15	16	20	6486505R	418,24	6487605R	430,12
20	16	25	6486605R	436,87	6487705R	451,13
25	16	32	6486705R	461,98	6487805R	480,99
32	16	40	6486805R	491,92	6487905R	515,69
40	16	50	6486905R	632,79	6488005R	661,32
50	16	63	6487005R	779,61	6488105R	824,76
65	10	75	6487105R	1.372,18	6488205R	1.445,85
80	10	90	6487205R	1.658,12	6488305R	1.748,44
100	10	110	6487305R	1.884,64	6488405R	1.984,94

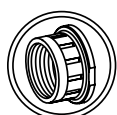
C08 | FAM VAL385

VALVOLE A SFERA PVC-C
 filetto femmina BSP
 rinforzo in acciaio inossidabile

CPVC BALL VALVE
 female thread BSP
 Stainless steel reinforcement

DN	PN	G	EPDM	€	FPM	€
10	16	3/8"	6514605R	426,20	6515605R	438,09
15	16	1/2"	6514705R	426,20	6515705R	438,09
20	16	3/4"	6514805R	445,19	6515805R	459,45
25	16	1"	6514905R	471,96	6515905R	490,98
32	16	1 1/4"	6515005R	503,56	6516005R	527,33
40	16	1 1/2"	6515105R	647,41	6516105R	675,94
50	16	2"	6515205R	796,48	6516205R	841,64
65	10	2 1/2"	6515305R	1.392,86	6516305R	1.466,54
80	10	3"	6515405R	1.681,53	6516405R	1.771,86
100	10	4"	6515505R	1.902,80	6516505R	2.003,10

C08 | FAM VAL385

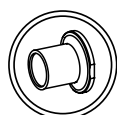
VALVOLE A SFERA PVC-C
 incollaggio maschio ISO/DIN

CPVC BALL VALVE
 male solvent socket ISO/DIN



DN	PN	D	EPDM	€	FPM	€
10	16	16	6742005R	421,10	6742105R	432,98
15	16	20	6687505R	421,10	6742205R	432,98
20	16	25	6687605R	440,31	6742305R	455,27
25	16	32	6687705R	466,26	6742405R	485,28
32	16	40	6687805R	497,15	6742505R	520,92
40	16	50	6687905R	639,46	6742605R	667,97
50	16	63	6688005R	787,93	6742705R	833,09
65	10	75	6743205R	1.389,72	6743405R	1.467,08
80	10	90	6743305R	1.680,17	6743505R	1.775,01
100	10	110	6855605R	1.916,48	6855705R	2.016,79

PVC-C

VALVOLE A SFERA PVC-C SERIE EXTREME - ATTUATORE PNEUMATICO SEMPLICE EFFETTO (NC)
CPVC BALL VALVE EXTREME SERIES - PNEUMATIC ACTUATOR SPRING RETURN (NC)

rotork

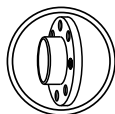
C08 | FAM VAL385



VALVOLE A SFERA PVC-C

flange ISO in PVC-C
flangia libera (RF)

CPVC BALL VALVE

CPVC ISO flanges
loose flange (RF)

DN	PN	D	EPDM	€	FPM	€
15	16	20	6490105R	446,77	6485105R	458,64
20	16	25	6490205R	470,86	6485205R	485,12
25	16	32	6490305R	504,04	6485305R	523,07
32	16	40	6490405R	541,36	6485405R	565,13
40	16	50	6490505R	691,26	6485505R	719,79
50	16	63	6490605R	856,86	6485605R	902,01
65	10	75	6490705R	1.486,26	6485705R	1.559,94
80	10	90	6490805R	1.788,13	6485805R	1.878,45
100	10	110	6490905R	2.267,89	6485905R	2.368,20

C08 | FAM VAL385

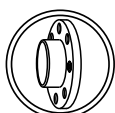

VALVOLE A SFERA PVC-C

flange ANSI-150 in PVC-C
flangia fissa (FF)

CPVC BALL VALVE

CPVC ANSI-150 flanges
fixed flange (FF)

DN	PN	D	EPDM	€	FPM	€
15	16	½"	72235AB05R	473,67	72241AB05R	488,00
20	16	¾"	72236AB05R	502,87	72242AB05R	519,40
25	16	1"	72237AB05R	541,89	72243AB05R	563,91
32	16	1¼"	72238AB05R	582,15	72244AB05R	609,68
40	16	1½"	72239AB05R	741,75	72245AB05R	774,80
50	16	2"	72240AB05R	934,59	72246AB05R	986,92
65	10	2½"	72247AB05R	1.649,83	72250AB05R	1.798,35
80	10	3"	72248AB05R	1.905,15	72251AB05R	2.007,76
100	10	4"	72249AB05R	2.521,59	72252AB05R	2.641,20

Accessori PVC-U

Valvole PVC-U

Accessori PVC-C

Valvole PVC-C

Valvole Extreme

Evacuazione

Ricambi

PVC-C

VALVOLE A SFERA PVC-C SERIE EXTREME - ATTUATORE PNEUMATICO DOPPIO EFFETTO
CPVC BALL VALVE EXTREME SERIES - PNEUMATIC ACTUATOR DOUBLE ACTING

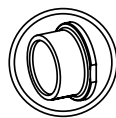

C08 | FAM VAL385

VALVOLE A SFERA PVC-C
 incollaggio femmina ISO/DIN

CPVC BALL VALVE
 metric solvent socket ISO/DIN

DN	PN	D	EPDM	€	FPM	€
10	16	16	6486407R	385,25	6487507R	397,14
15	16	20	6486507R	385,25	6487607R	397,14
20	16	25	6486607R	395,13	6487707R	409,39
25	16	32	6486707R	405,26	6487807R	424,27
32	16	40	6486807R	417,06	6487907R	440,83
40	16	50	6486907R	436,70	6488007R	465,22
50	16	63	6487007R	477,74	6488107R	522,89
65	10	75	6487107R	824,83	6488207R	898,51
80	10	90	6487207R	938,33	6488307R	1.028,64
100	10	110	6487307R	1.118,86	6488407R	1.216,73

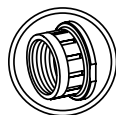
C08 | FAM VAL385

VALVOLE A SFERA PVC-C
 filetto femmina BSP
 rinforzo in acciaio inossidabile

CPVC BALL VALVE
 female thread BSP
 Stainless steel reinforcement

DN	PN	G	EPDM	€	FPM	€
10	16	3/8"	6514607R	393,22	6515607R	405,10
15	16	1/2"	6514707R	393,22	6515707R	405,10
20	16	3/4"	6514807R	403,45	6515807R	417,71
25	16	1"	6514907R	415,24	6515907R	434,25
32	16	1 1/4"	6515007R	428,71	6516007R	452,48
40	16	1 1/2"	6515107R	451,32	6516107R	479,84
50	16	2"	6515207R	494,61	6516207R	539,77
65	10	2 1/2"	6515307R	845,51	6516307R	919,19
80	10	3"	6515407R	961,73	6516407R	1.052,05
100	10	4"	6515507R	1.136,58	6516507R	1.234,45

C08 | FAM VAL385

VALVOLE A SFERA PVC-C
 incollaggio maschio ISO/DIN

CPVC BALL VALVE
 male solvent socket ISO/DIN

DN	PN	D	EPDM	€	FPM	€
10	16	16	6742007R	388,11	6742107R	399,99
15	16	20	6687507R	388,11	6742207R	399,99
20	16	25	6687607R	398,57	6742307R	413,53
25	16	32	6687707R	409,54	6742407R	428,55
32	16	40	6687807R	422,29	6742507R	446,06
40	16	50	6687907R	443,36	6742607R	471,87
50	16	63	6688007R	486,06	6742707R	531,22
65	10	75	6743207R	842,37	6743407R	919,73
80	10	90	6743307R	960,37	6743507R	1.055,20
100	10	110	6855607R	1.149,93	6855707R	1.247,80

PVC-C

VALVOLE A SFERA PVC-C SERIE EXTREME - ATTUATORE PNEUMATICO DOPPIO EFFETTO
CPVC BALL VALVE EXTREME SERIES - PNEUMATIC ACTUATOR DOUBLE ACTING

rotork

C08 | FAM VAL385

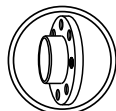

VALVOLE A SFERA PVC-C

flange ISO in PVC-C
flangia libera (RF)

CPVC BALL VALVE

CPVC ISO flanges
loose flange (RF)

DN	PN	D	EPDM	€	FPM	€
15	16	20	6490107R	413,77	6485107R	425,65
20	16	25	6490207R	429,12	6485207R	443,38
25	16	32	6490307R	447,32	6485307R	466,33
32	16	40	6490407R	466,51	6485407R	490,27
40	16	50	6490507R	495,17	6485507R	523,69
50	16	63	6490607R	554,98	6485607R	600,14
65	10	75	6490707R	938,92	6485707R	1.012,60
80	10	90	6490807R	1.068,33	6485807R	1.158,64
100	10	110	6490907R	1.492,77	6485907R	1.590,64

C08 | FAM VAL385

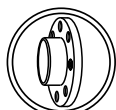

VALVOLE A SFERA PVC-C

flange ANSI-150 in PVC-C
flangia fissa (FF)

CPVC BALL VALVE

CPVC ANSI-150 flanges
fixed flange (FF)

DN	PN	D	EPDM	€	FPM	€
15	16	½"	72235AB07R	440,69	72241AB07R	455,02
20	16	¾"	72236AB07R	461,13	72242AB07R	477,66
25	16	1"	72237AB07R	485,17	72243AB07R	507,19
32	16	1¼"	72238AB07R	507,28	72244AB07R	534,82
40	16	1½"	72239AB07R	545,66	72245AB07R	578,72
50	16	2"	72240AB07R	632,72	72246AB07R	685,05
65	10	2½"	72247AB07R	1.102,48	72250AB07R	1.251,00
80	10	3"	72248AB07R	1.185,35	72251AB07R	1.287,96
100	10	4"	72249AB07R	1.755,82	72252AB07R	1.875,43

Accessori PVC-U

Valvole PVC-U

Accessori PVC-C

Valvole PVC-C

Valvole Extreme

Evacuazione

Ricambi

PVC-C

VALVOLE A SFERA PVC-C SERIE EXTREME - ATTUATORE ELETTRICO 85-240V AC/DC
CPVC BALL VALVE EXTREME SERIES - ELECTRIC ACTUATOR 85-240V AC/DC

C08 | FAM VAL375

VALVOLE A SFERA PVC-C
 incollaggio femmina ISO/DIN

CPVC BALL VALVE
 metric solvent socket ISO/DIN

DN	PN	D	EPDM		€	FPM		€
			85-240V	24V		85-240V	24V	
10	16	16	6486409J	6486410J	570,63	6487509J	6487510J	582,51
15	16	20	6486509J	6486510J	570,63	6487609J	6487610J	582,51
20	16	25	6486609J	6486610J	577,24	6487709J	6487710J	591,50
25	16	32	6486709J	6486710J	590,74	6487809J	6487810J	609,75
32	16	40	6486809J	6486810J	602,80	6487909J	6487910J	626,57
40	16	50	6486909J *		801,58	6488009J *		830,10
50	16	63	6487009J *		877,93	6488109J *		923,09
65	10	75	6487109J *		1.151,98	6488209J *		1.225,65
80	10	90	6487209J *		1.486,35	6488309J *		1.576,66
100	10	110	6487309J *		2.055,72	6488409J *		2.153,58

C08 | FAM VAL375

VALVOLE A SFERA PVC-C
 filetto femmina BSP
 rinforzo in acciaio inossidabile

CPVC BALL VALVE
 female thread BSP
 Stainless steel reinforcement

DN	PN	G	EPDM		€	FPM		€
			85-240V	24V		85-240V	24V	
10	16	3/8"	6514609J	6514610J	578,59	6515609J	6515610J	590,47
15	16	1/2"	6514709J	6514710J	578,59	6515709J	6515710J	590,47
20	16	3/4"	6514809J	6514810J	585,55	6515809J	6515810J	599,82
25	16	1"	6514909J	6514910J	600,72	6515909J	6515910J	619,73
32	16	1 1/4"	6515009J	6515010J	614,44	6516009J	6516010J	638,21
40	16	1 1/2"	6515109J *		816,20	6516109J *		844,72
50	16	2"	6515209J *		894,81	6516209J *		939,97
65	10	2 1/2"	6515309J *		1.172,65	6516309J *		1.246,33
80	10	3"	6515409J *		1.509,76	6516409J *		1.600,07
100	10	4"	6515509J *		2.073,44	6516509J *		2.171,31

C08 | FAM VAL375

VALVOLE A SFERA PVC-C
 incollaggio maschio ISO/DIN

CPVC BALL VALVE
 male solvent socket ISO/DIN

DN	PN	D	EPDM		€	FPM		€
			85-240V	24V		85-240V	24V	
10	16	16	6742009J	6742010J	573,49	6742109J	6742110J	585,37
15	16	20	6687509J	6687510J	573,49	6742209J	6742210J	585,37
20	16	25	6687609J	6687610J	580,68	6742309J	6742310J	595,64
25	16	32	6687709J	6687710J	595,02	6742409J	6742410J	614,03
32	16	40	6687809J	6687810J	608,03	6742509J	6742510J	631,79
40	16	50	6687909J *		808,24	6742609J *		836,77
50	16	63	6688009J *		886,25	6742709J *		931,40
65	10	75	6743209J *		1.169,51	6743409J *		1.246,87
80	10	90	6743309J *		1.508,38	6743509J *		1.603,22
100	10	110	6855609J *		2.086,79	6855709J *		2.184,66

* Multivoltaggio 24-240V AC/DC

* Multivoltage 24-240V AC/DC

PVC-C

VALVOLE A SFERA PVC-C SERIE EXTREME - ATTUATORE ELETTRICO 85-240V AC/DC
CPVC BALL VALVE EXTREME SERIES - ELECTRIC ACTUATOR 85-240V AC/DC

J+J

C08 | FAM VAL375



VALVOLE A SFERA PVC-C
flange ISO in PVC-C
flangia libera (RF)

CPVC BALL VALVE
CPVC ISO flanges
loose flange (RF)



DN	PN	D	EPDM		€	FPM		€
			85-240V	24V		85-240V	24V	
15	16	20	6490109J	6490110J	599,15	6485109J	6485110J	611,04
20	16	25	6490209J	6490210J	611,22	6485209J	6485210J	625,48
25	16	32	6490309J	6490310J	632,80	6485309J	6485310J	651,81
32	16	40	6490409J	6490410J	652,24	6485409J	6485410J	676,00
40	16	50	6490509J *		860,05	6485509J *		888,57
50	16	63	6490609J *		955,17	6485609J *		1.000,33
65	10	75	6490709J *		1.266,05	6485709J *		1.339,74
80	10	90	6490809J *		1.616,35	6485809J *		1.706,67
100	10	110	6490909J *		2.429,63	6485909J *		2.527,49

C08 | FAM VAL375



VALVOLE A SFERA PVC-C
flange ANSI-150 in PVC-C
flangia fissa (FF)

CPVC BALL VALVE
CPVC ANSI-150 flanges
fixed flange (FF)



DN	PN	D	EPDM		€	FPM		€
			85-240V	24V		85-240V	24V	
15	16	½"	72235AB09J	72235AB10J	626,06	72241AB09J	72241AB10J	640,39
20	16	¾"	72236AB09J	72236AB10J	643,23	72242AB09J	72242AB10J	659,76
25	16	1"	72237AB09J	72237AB10J	670,65	72243AB09J	72243AB10J	692,67
32	16	1¼"	72238AB09J	72238AB10J	693,02	72244AB09J	72244AB10J	720,56
40	16	1½"	72239AB09J *		910,55	72245AB09J *		943,60
50	16	2"	72240AB09J *		1.032,91	72246AB09J *		1.085,24
65	10	2½"	72247AB09J *		1.429,63	72250AB09J *		1.578,15
80	10	3"	72248AB09J *		1.733,38	72251AB09J *		1.835,99
100	10	4"	72249AB09J *		2.692,67	72252AB09J *		2.812,29

* Multivoltaggio 24-240V AC/DC

* Multivoltage 24-240V AC/DC

Accessori PVC-U

Valvole PVC-U

Accessori PVC-C

Valvole PVC-C

Valvole Extreme

Evacuazione

Ricambi

PP-H

VALVOLE A SFERA PP-H SERIE EXTREME - ATTUATORE PNEUMATICO SEMPLICE EFFETTO (NC)
PP-H BALL VALVE EXTREME SERIES - PNEUMATIC ACTUATOR SPRING RETURN (NC)

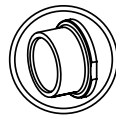

C08 | FAM VAL385

VALVOLE A SFERA PP-H
 elettrofusione

PP-H BALL VALVE
 socket fusion

DN	PN	D	EPDM	€	FPM	€
10	10	16	6491005R	411,11	6516605R	423,00
15	10	20	6491105R	411,11	6516705R	423,00
20	10	25	6491205R	428,55	6516805R	442,81
25	10	32	6491305R	451,29	6516905R	470,30
32	10	40	6491405R	478,85	6517005R	502,62
40	10	50	6491505R	614,97	6517105R	643,49
50	10	63	6491605R	754,66	6517205R	799,82
65	6	75	6692705R	1.334,51	6754205R	1.408,19
80	6	90	6692805R	1.592,06	6754305R	1.682,37
100	6	110	6850905R	1.971,12	6851005R	2.071,43

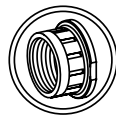
C08 | FAM VAL385

VALVOLE A SFERA PP-H
 filetto femmina BSP
 rinforzo in acciaio inossidabile

PP-H BALL VALVE
 female thread BSP
 Stainless steel reinforcement

DN	PN	G	EPDM	€	FPM	€
10	10	3/8"	6491705R	419,07	6517305R	430,96
15	10	1/2"	6491805R	419,07	6517405R	430,96
20	10	3/4"	6491905R	436,87	6517505R	451,13
25	10	1"	6492005R	461,26	6517605R	480,29
32	10	1 1/4"	6492105R	490,50	6517705R	514,26
40	10	1 1/2"	6492205R	629,59	6517805R	658,10
50	10	2"	6492305R	771,53	6517905R	816,68
65	6	2 1/2"	6855805R	1.355,18	6856405R	1.428,87
80	6	3"	6856005R	1.615,46	6856505R	1.705,78
100	6	4"	6856205R	2.004,66	6856605R	2.104,97

C08 | FAM VAL385

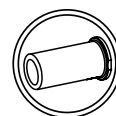
VALVOLE A SFERA PP-H
 saldatura testa a testa
 PP-H / SDR11

PP-H BALL VALVE
 butt welding
 PP-H / SDR11

DN	PN	D	EPDM	€	FPM	€
15	10	20	6462205R	415,51	6453905R	427,39
20	10	25	6462305R	433,78	6484605R	448,04
25	10	32	6462405R	459,49	6484705R	478,50
32	10	40	6462505R	487,17	6484805R	510,94
40	10	50	6462605R	625,19	6484905R	654,55
50	10	63	6462705R	764,87	6485005R	810,03
65	6	75	6856805R	1.359,55	6857105R	1.433,24
80	6	90	6856905R	1.622,04	6857205R	1.712,36
100	6	110	6857005R	2.028,98	6857305R	2.129,30

Per attuatori SE - NA, Consultare

For SR - NO actuator, ask for the code

PP-H

VALVOLE A SFERA PP-H SERIE EXTREME - ATTUATORE PNEUMATICO SEMPLICE EFFETTO (NC)
PP-H BALL VALVE EXTREME SERIES - PNEUMATIC ACTUATOR SPRING RETURN (NC)



C08 | FAM VAL385

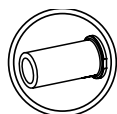

VALVOLE A SFERA PP-H
PE100 / SDR11

PP-H BALL VALVE
PE100 / SDR11



DN	PN	D	EPDM	€	FPM	€
15	10	20	6506705R	415,51	6518105R	427,39
20	10	25	6506805R	433,78	6518205R	448,04
25	10	32	6518005R	459,49	6518305R	478,50
32	10	40	6506905R	487,17	6518405R	510,94
40	10	50	6507005R	625,19	6518505R	654,55
50	10	63	6507105R	764,87	6518605R	810,03
65	6	75	6747305R	1.357,14	6857505R	1.430,82
80	6	90	6747405R	1.619,14	6857605R	1.709,45
100	6	110	6857405R	2.022,14	6857705R	2.122,44

C08 | FAM VAL385

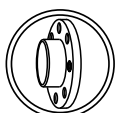

VALVOLE A SFERA PP-H
flange ISO in acciaio rivestite in PP
flangia libera (RF)

PP-H BALL VALVE
PP steel coated ISO flanges
loose flange (RF)



DN	PN	D	EPDM	€	FPM	€
15	10	20	7229305R	547,35	7229905R	560,85
20	10	25	7229405R	581,76	7230005R	597,96
25	10	32	7229505R	641,42	7230105R	663,01
32	10	40	7229605R	683,83	7230205R	710,83
40	10	50	7229705R	896,22	7230305R	928,62
50	10	63	7229805R	1.056,48	7230405R	1.107,78
65	6	75	7231605R	1.824,05	7231905R	1.907,76
80	6	90	7231705R	2.060,26	7232005R	2.162,87
100	6	110	7231805R	2.588,85	7232105R	2.702,25

C08 | FAM VAL385

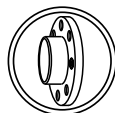

VALVOLE A SFERA PP-H
flange ISO in PP-H
flangia fissa (FF)

PP-H BALL VALVE
PP-H ISO flanges
fixed flange (FF)



DN	PN	D	EPDM	€	FPM	€
15	10	20	6665205R	439,86	6665805R	451,98
20	10	25	6665305R	462,78	6665905R	477,32
25	10	32	6665405R	493,60	6666005R	512,98
32	10	40	6665505R	528,87	6666105R	553,13
40	10	50	6665605R	673,79	6666205R	702,89
50	10	63	6665705R	830,71	6666305R	876,77
65	6	75	6727605R	1.457,14	6727705R	1.530,82
80	6	90	6727805R	1.726,88	6727905R	1.817,20
100	6	110	6848205R	2.157,48	6848305R	2.253,02

Accessori PVC-U

Valvole PVC-U

Accessori PVC-C

Valvole PVC-C

Valvole Extreme

Evacuazione

Ricambi

PP-H

VALVOLE A SFERA PP-H SERIE EXTREME - ATTUATORE PNEUMATICO SEMPLICE EFFETTO (NC)
PP-H BALL VALVE EXTREME SERIES - PNEUMATIC ACTUATOR SPRING RETURN (NC)

C08 | FAM VAL385

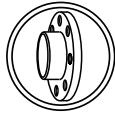
**VALVOLE A SFERA PP-H**
 flange ANSI-150 in acciaio rivestite in
 PP
 flangia libera (RF)
PP-H BALL VALVE
 PP steel coated ANSI-150 flanges
 loose flange (RF)

DN	PN	D	EPDM	€	FPM	€
15	10	½"	72293AB05R	547,35	72299AB05R	560,85
20	10	¾"	72294AB05R	581,76	72300AB05R	597,96
25	10	1"	72295AB05R	641,42	72301AB05R	663,01
32	10	1¼"	72296AB05R	683,83	72302AB05R	710,83
40	10	1½"	72297AB05R	896,22	72303AB05R	928,62
50	10	2"	72298AB05R	1.056,48	72304AB05R	1.107,78
65	6	2½"	72316AB05R	1.824,05	72319AB05R	1.907,76
80	6	3"	72317AB05R	2.060,26	72320AB05R	2.162,87
100	6	4"	72318AB05R	2.588,85	72321AB05R	2.702,25

Accessori PVC-U

Valvole PVC-U

Accessori PVC-C

Valvole PVC-C

Valvole Extreme

Evacuazione

Ricambi

PP-H

VALVOLE A SFERA PP-H SERIE EXTREME - ATTUATORE PNEUMATICO DOPPIO EFFETTO
PP-H BALL VALVE EXTREME SERIES - PNEUMATIC ACTUATOR DOUBLE ACTING

rotork

C08 | FAM VAL385

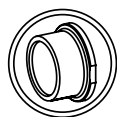

VALVOLE A SFERA PP-H
elettrofusione

PP-H BALL VALVE
socket fusion

DN	PN	D	EPDM	€	FPM	€
10	10	16	6491007R	378,13	6516607R	390,01
15	10	20	6491107R	378,13	6516707R	390,01
20	10	25	6491207R	386,81	6516807R	401,07
25	10	32	6491307R	394,56	6516907R	413,58
32	10	40	6491407R	404,00	6517007R	427,77
40	10	50	6491507R	418,87	6517107R	447,40
50	10	63	6491607R	452,79	6517207R	497,94
65	6	75	6692707R	787,16	6754207R	860,84
80	6	90	6692807R	872,25	6754307R	962,57
100	6	110	6850907R	1.203,23	6851007R	1.301,11

C08 | FAM VAL385

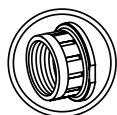

VALVOLE A SFERA PP-H
filetto femmina BSP
rinforzo in acciaio inossidabile

PP-H BALL VALVE
female thread BSP
Stainless steel reinforcement

DN	PN	G	EPDM	€	FPM	€
10	10	3/8"	6491707R	386,09	6517307R	397,97
15	10	1/2"	6491807R	386,09	6517407R	397,97
20	10	3/4"	6491907R	395,13	6517507R	409,39
25	10	1"	6492007R	404,54	6517607R	423,55
32	10	1 1/4"	6492107R	415,63	6517707R	439,40
40	10	1 1/2"	6492207R	433,49	6517807R	462,02
50	10	2"	6492307R	469,66	6517907R	514,81
65	6	2 1/2"	6855807R	807,84	6856407R	881,52
80	6	3"	6856007R	895,65	6856507R	985,97
100	6	4"	6856207R	1.235,96	6856607R	1.333,84

C08 | FAM VAL385

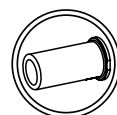

VALVOLE A SFERA PP-H
saldatura testa a testa
PP-H / SDR11

PP-H BALL VALVE
butt welding
PP-H / SDR11

DN	PN	D	EPDM	€	FPM	€
15	10	20	6462207R	382,52	6453907R	394,41
20	10	25	6462307R	392,04	6484607R	406,30
25	10	32	6462407R	402,76	6484707R	421,78
32	10	40	6462507R	412,31	6484807R	436,08
40	10	50	6462607R	429,09	6484907R	458,45
50	10	63	6462707R	463,00	6485007R	508,16
65	6	75	6856807R	812,22	6857107R	885,89
80	6	90	6856907R	902,24	6857207R	992,56
100	6	110	6857007R	1.259,70	6857307R	1.357,56

Accessori PVC-U

Valvole PVC-U

Accessori PVC-C

Valvole PVC-C

Valvole Extreme

Evacuazione

Ricambi

PP-H

VALVOLE A SFERA PP-H SERIE EXTREME - ATTUATORE PNEUMATICO DOPPIO EFFETTO
PP-H BALL VALVE EXTREME SERIES - PNEUMATIC ACTUATOR DOUBLE ACTING

C08 | FAM VAL385

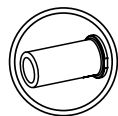

VALVOLE A SFERA PP-H
 PE100 / SDR11

PP-H BALL VALVE
 PE100 / SDR11

DN	PN	D	EPDM	€	FPM	€
15	10	20	6506707R	382,52	6518107R	394,41
20	10	25	6506807R	392,04	6518207R	406,30
25	10	32	6518007R	402,76	6518307R	421,78
32	10	40	6506907R	412,31	6518407R	436,08
40	10	50	6507007R	429,09	6518507R	458,45
50	10	63	6507107R	463,00	6518607R	508,16
65	6	75	6747307R	809,79	6857507R	883,48
80	6	90	6747407R	899,34	6857607R	989,66
100	6	110	6857407R	1.253,01	6857707R	1.350,87

C08 | FAM VAL385

Accessori PVC-U

Valvole PVC-U

Accessori PVC-C

Valvole PVC-C

Valvole Extreme

Evacuazione

Ricambi

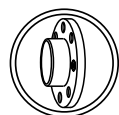
VALVOLE A SFERA PP-H
 flange ISO in acciaio
 rivestite in PP
 flangia libera (RF)

PP-H BALL VALVE
 PP steel coated ISO flanges
 loose flange (RF)

DN	PN	D	EPDM	€	FPM	€
15	10	20	7229307R	514,37	7229907R	527,87
20	10	25	7229407R	540,02	7230007R	556,22
25	10	32	7229507R	584,68	7230107R	606,28
32	10	40	7229607R	608,98	7230207R	635,98
40	10	50	7229707R	700,12	7230307R	732,52
50	10	63	7229807R	754,61	7230407R	805,91
65	6	75	7231607R	1.276,70	7231907R	1.360,41
80	6	90	7231707R	1.340,45	7232007R	1.443,06
100	6	110	7231807R	1.820,97	7232107R	1.934,37

C08 | FAM VAL385

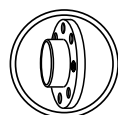
VALVOLE A SFERA PP-H
 flange ISO in PP-H
 flangia fissa (FF)

PP-H BALL VALVE
 PP-H ISO flanges
 fixed flange (FF)

DN	PN	D	EPDM	€	FPM	€
15	10	20	6665207R	406,88	6665807R	419,00
20	10	25	6665307R	421,04	6665907R	435,59
25	10	32	6665407R	436,86	6666007R	456,26
32	10	40	6665507R	454,02	6666107R	478,26
40	10	50	6665607R	477,69	6666207R	506,79
50	10	63	6665707R	528,84	6666307R	574,90
65	6	75	6727607R	909,80	6727707R	983,47
80	6	90	6727807R	1.007,07	6727907R	1.097,39
100	6	110	6848207R	1.385,06	6848307R	1.478,27

PP-H

VALVOLE A SFERA PP-H SERIE EXTREME - ATTUATORE PNEUMATICO DOPPIO EFFETTO
PP-H BALL VALVE EXTREME SERIES - PNEUMATIC ACTUATOR DOUBLE ACTING

rotork

C08 | FAMVAL385

Accessori PVC-U

Valvole PVC-U

Accessori PVC-C

Valvole PVC-C

Valvole Extreme

Evacuazione

Ricambi

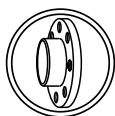

VALVOLE A SFERA PP-H

flange ANSI-150 in acciaio
rivestite in PP
flangia libera (RF)

PP-H BALL VALVE

PP steel coated ANSI-150 flanges
loose flange (RF)

DN	PN	D	EPDM	€	FPM	€
15	10	½"	72293AB07R	514,37	72299AB07R	527,87
20	10	¾"	72294AB07R	540,02	72300AB07R	556,22
25	10	1"	72295AB07R	584,68	72301AB07R	606,28
32	10	1¼"	72296AB07R	608,98	72302AB07R	635,98
40	10	1½"	72297AB07R	700,12	72303AB07R	732,52
50	10	2"	72298AB07R	754,61	72304AB07R	805,91
65	6	2½"	72316AB07R	1.276,70	72319AB07R	1.360,41
80	6	3"	72317AB07R	1.340,45	72320AB07R	1.443,06
100	6	4"	72318AB07R	1.820,97	72321AB07R	1.934,37

PP-H

VALVOLE A SFERA PP-H SERIE EXTREME - ATTUATORE ELETTRICO 85-240V AC/DC
PP-H BALL VALVE EXTREME SERIES - ELECTRIC ACTUATOR 85-240V AC/DC

C08 | FAM VAL375

VALVOLE A SFERA PP-H
 elettrofusione

PP-H BALL VALVE
 socket fusion

DN	PN	D	EPDM		€	FPM		€
			85-240V	24V		85-240V	24V	
10	16	16	6491009J	6491010J	563,50	6516609J	6516610J	575,38
15	16	20	6491109J	6491110J	563,50	6516709J	6516710J	575,38
20	16	25	6491209J	6491210J	568,92	6516809J	6516810J	583,17
25	16	32	6491309J	6491310J	580,03	6516909J	6516910J	599,06
32	16	40	6491409J	6491410J	589,73	6517009J	6517010J	613,49
40	16	50	6491509J *		783,75	6517109J *		812,28
50	16	63	6491609J *		852,97	6517209J *		898,13
65	10	75	6692709J *		1.114,30	6754209J *		1.187,99
80	10	90	6692809J *		1.420,27	6754309J *		1.510,59
100	10	110	6850909J *		2.140,09	6851009J *		2.237,95

C08 | FAM VAL375

VALVOLE A SFERA PP-H
 filetto femmina BSP
 rinforzo in acciaio inossidabile

PP-H BALL VALVE
 female thread BSP
 Stainless steel reinforcement

DN	PN	G	EPDM		€	FPM		€
			85-240V	24V		85-240V	24V	
10	16	3/8"	6491709J	6491710J	571,46	6517309J	6517310J	583,35
15	16	1/2"	6491809J	6491810J	571,46	6517409J	6517410J	583,35
20	16	3/4"	6491909J	6491910J	577,24	6517509J	6517510J	591,50
25	16	1"	6492009J	6492010J	590,02	6517609J	6517610J	609,03
32	16	1 1/4"	6492109J	6492110J	601,37	6517709J	6517710J	625,14
40	16	1 1/2"	6492209J *		798,37	6517809J *		826,90
50	16	2"	6492309J *		869,85	6517909J *		915,01
65	10	2 1/2"	6855809J *		1.134,98	6856409J *		1.208,66
80	10	3"	6856009J *		1.443,68	6856509J *		1.534,00
100	10	4"	6856209J *		2.172,82	6856609J *		2.270,68

C08 | FAM VAL375

VALVOLE A SFERA PP-H
 saldatura testa a testa
 PP-H / SDR11

PP-H BALL VALVE
 butt welding
 PP-H / SDR11

DN	PN	D	EPDM		€	FPM		€
			85-240V	24V		85-240V	24V	
15	16	20	6462209J	6462210J	567,89	6453909J	6453910J	579,78
20	16	25	6462309J	6462310J	574,15	6484609J	6484610J	588,40
25	16	32	6462409J	6462410J	588,24	6484709J	6484710J	607,25
32	16	40	6462509J	6462510J	598,05	6484809J	6484810J	621,82
40	16	50	6462609J *		793,98	6484909J *		823,33
50	16	63	6462709J *		863,19	6485009J *		908,35
65	10	75	6856809J *		1.139,35	6857109J *		1.213,03
80	10	90	6856909J *		1.450,26	6857209J *		1.540,58
100	10	110	6857009J *		2.196,56	6857309J *		2.294,42

* Multivoltaggio 24-240V AC/DC

* Multivoltage 24-240V AC/DC

PP-H

VALVOLE A SFERA PP-H SERIE EXTREME - ATTUATORE ELETTRICO 85-240V AC/DC
PP-H BALL VALVE EXTREME SERIES - ELECTRIC ACTUATOR 85-240V AC/DC



C08 | FAM VAL375

Accessori PVC-U

Valvole PVC-U

Accessori PVC-C

Valvole PVC-C

Valvole Extreme

Evacuazione

Ricambi



VALVOLE A SFERA PP-H
PE100 / SDR11

PP-H BALL VALVE
PE100 / SDR11



DN	PN	D	EPDM		€	FPM		€
			85-240V	24V		85-240V	24V	
15	16	20	6506709J	6506710J	567,89	6518109J	6518110J	579,78
20	16	25	6506809J	6506810J	574,15	6518209J	6518210J	588,40
25	16	32	6518009J	6518010J	588,24	6518309J	6518310J	607,25
32	16	40	6506909J	6506910J	598,05	6518409J	6518410J	621,82
40	16	50	6507009J *		793,98	6518509J *		823,33
50	16	63	6507109J *		863,19	6518609J *		908,35
65	10	75	6747309J *		1.136,94	6857509J *		1.210,62
80	10	90	6747409J *		1.447,36	6857609J *		1.537,68
100	10	110	6857409J *		2.189,86	6857709J *		2.287,73

C08 | FAM VAL375



VALVOLE A SFERA PP-H
flange ISO in acciaio
rivestite in PP
flangia libera (RF)

PP-H BALL VALVE
PP steel coated ISO flanges
loose flange (RF)



DN	PN	D	EPDM		€	FPM		€
			85-240V	24V		85-240V	24V	
15	16	20	7229309J	7229310J	699,74	7229909J	7229910J	713,24
20	16	25	7229409J	7229410J	722,13	7230009J	7230010J	738,33
25	16	32	7229509J	7229510J	770,16	7230109J	7230110J	791,76
32	16	40	7229609J	7229610J	794,72	7230209J	7230210J	821,72
40	16	50	7229709J *		1.065,00	7230309J *		1.097,40
50	16	63	7229809J *		1.154,79	7230409J *		1.206,09
65	10	75	7231609J *		1.603,84	7231909J *		1.687,55
80	10	90	7231709J *		1.888,48	7232009J *		1.991,09
100	10	110	7231809J *		2.757,83	7232109J *		2.871,23

C08 | FAM VAL375



VALVOLE A SFERA PP-H
flange ISO in PP-H
flangia fissa (FF)

PP-H BALL VALVE
PP-H ISO flanges
fixed flange (FF)

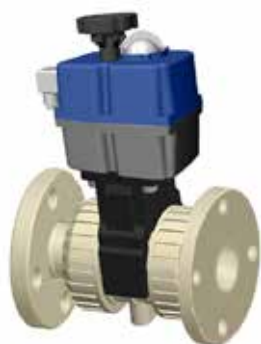

DN	PN	D	EPDM		€	FPM		€
			85-240V	24V		85-240V	24V	
15	16	20	6665209J	6665210J	592,26	6665809J	6665810J	604,38
20	16	25	6665309J	6665310J	603,14	6665909J	6665910J	617,69
25	16	32	6665409J	6665410J	622,34	6666009J	6666010J	641,74
32	16	40	6665509J	6665510J	639,76	6666109J	6666110J	664,00
40	16	50	6665609J *		842,57	6666209J *		871,67
50	16	63	6665709J *		929,03	6666309J *		975,09
65	10	75	6727609J *		1.236,94	6727709J *		1.310,61
80	10	90	6727809J *		1.555,10	6727909J *		1.645,41
100	10	110	6848209J *		2.321,92	6848309J *		2.415,12

* Multivoltaggio 24-240V AC/DC

* Multivoltage 24-240V AC/DC

PP-H

VALVOLE A SFERA PP-H SERIE EXTREME - ATTUATORE ELETTRICO 85-240V AC/DC
PP-H BALL VALVE EXTREME SERIES - ELECTRIC ACTUATOR 85-240V AC/DC

C08 | FAM VAL375

**VALVOLE A SFERA PP-H**
 flange ANSI-150 in acciaio
 rivestite in PP
 flangia libera (RF)
PP-H BALL VALVE
 PP steel coated ANSI-150 flanges
 loose flange (RF)

DN	PN	D	EPDM		€	FPM		€
			85-240V	24V		85-240V	24V	
15	16	1/2"	72293AB09J	72293AB10J	699,74	72299AB09J	72299AB10J	713,24
20	16	3/4"	72294AB09J	72294AB10J	722,13	72300AB09J	72300AB10J	738,33
25	16	1"	72295AB09J	72295AB10J	770,16	72301AB09J	72301AB10J	791,76
32	16	1 1/4"	72296AB09J	72296AB10J	794,72	72302AB09J	72302AB10J	821,72
40	16	1 1/2"	72297AB09J *		1.065,00	72303AB09J *		1.097,40
50	16	2"	72298AB09J *		1.154,79	72304AB09J *		1.141,96
65	10	2 1/2"	72316AB09J *		1.603,84	72319AB09J *		1.687,55
80	10	3"	72317AB09J *		1.888,48	72320AB09J *		1.860,35
100	10	4"	72318AB09J *		2.757,83	72321AB09J *		2.871,23

Accessori PVC-U

Valvole PVC-U

Accessori PVC-C

Valvole PVC-C

Valvole Extreme

Evacuazione

Ricambi

PVDF

VALVOLE A SFERA PVDF SERIE EXTREME - ATTUATORE PNEUMATICO SEMPLICE EFFETTO (NC)
PVDF BALL VALVE EXTREME SERIES - PNEUMATIC ACTUATOR SPRING RETURN (NC)

rotork

C08 | FAM VAL385

Accessori PVC-U

Valvole PVC-U

Accessori PVC-C

Valvole PVC-C

Valvole Extreme

Evacuazione

Ricambi

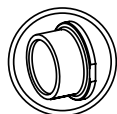

VALVOLE A SFERA PVDF
elettrofusione

PVDF BALL VALVE
socket fusion



DN	PN	D	EPDM	€	FPM	€
10	16	16	6492405R	439,51	6441505R	451,40
15	16	20	6492505R	439,51	6441605R	451,40
20	16	25	6492605R	467,42	6441705R	481,67
25	16	32	6492705R	504,29	6441805R	523,30
32	16	40	6492805R	553,72	6441905R	577,48
40	16	50	6492905R	748,42	6442005R	776,95
50	16	63	6493005R	955,49	6442105R	1.000,65
65	10	75	6863205R	1.905,79	6826605R	1.979,46
80	10	90	6863305R	2.358,41	6826705R	2.448,72
100	10	110	6932005R	2.964,93	6932105R	3.065,34

C08 | FAM VAL385



VALVOLE A SFERA PVDF
filetto femmina BSP
rinforzo in acciaio inossidabile

PVDF BALL VALVE
female thread BSP
Stainless steel reinforcement



DN	PN	G	EPDM	€	FPM	€
10	16	3/8"	6624805R	447,47	6631705R	459,36
15	16	1/2"	6624905R	447,47	6631805R	459,36
20	16	3/4"	6625005R	475,73	6631905R	490,00
25	16	1"	6625105R	514,27	6632005R	533,28
32	16	1 1/4"	6625205R	565,36	6632105R	589,13
40	16	1 1/2"	6625305R	763,05	6632205R	791,57
50	16	2"	6625405R	972,73	6632305R	1.017,88
65	10	2 1/2"	6932205R	1.964,19	6932605R	2.037,88
80	10	3"	6932305R	2.429,67	6932805R	2.519,99
100	10	4"	6932405R	3.044,57	6932905R	3.144,93

C08 | FAM VAL385

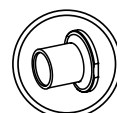

VALVOLE A SFERA PVDF
saldatura di tasca

PVDF BALL VALVE
spigot fusion



DN	PN	D	EPDM	€	FPM	€
15	16	20	6787005R	460,00	6787705R	473,22
20	16	25	6787105R	493,00	6787805R	508,76
25	16	32	6787205R	540,76	6787905R	561,41
32	16	40	6787305R	597,67	6788005R	623,58
40	16	50	6787405R	813,45	6788105R	845,60
50	16	63	6787505R	1.038,52	6788205R	1.086,78
65	10	75	7070605R	2.128,24	7071105R	2.213,62
80	10	90	7070805R	2.645,47	7071205R	2.750,14
100	10	110	7070905R	3.386,34	7071305R	3.499,82

PVDF

VALVOLE A SFERA PVDF SERIE EXTREME - ATTUATORE PNEUMATICO SEMPLICE EFFETTO (NC)
PVDF BALL VALVE EXTREME SERIES - PNEUMATIC ACTUATOR SPRING RETURN (NC)

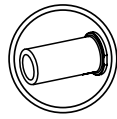

C08 | FAM VAL385

VALVOLE A SFERA PVDF
 saldatura testa a testa
 PVDF / SDR11

PVDF BALL VALVE
 butt fusion
 PVDF / SDR11

DN	PN	D	EPDM	€	FPM	€
15	16	20	6717505R	446,39	6718105R	457,79
20	16	25	6717605R	476,07	6718205R	489,66
25	16	32	6717705R	518,36	6718305R	536,18
32	16	40	6717805R	568,84	6718405R	591,21
40	16	50	6717905R	770,57	6718505R	798,33
50	16	63	6718005R	980,23	6718605R	1.021,88
65	10	75	6933005R	1.976,53	6933305R	2.050,21
80	10	90	6933105R	2.449,71	6933405R	2.540,03
100	10	110	6933205R	3.102,30	6933605R	3.202,67

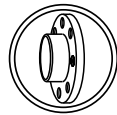
C08 | FAM VAL385

VALVOLE A SFERA PVDF
 flange ISO in acciaio rivestita in PP
 flangia libera (RF)

PVDF BALL VALVE
 PP steel coated ISO flanges
 loose flange (RF)

DN	PN	D	EPDM	€	FPM	€
15	16	20	6788305R	553,49	6599005R	565,15
20	16	25	6788405R	592,66	6599105R	606,29
25	16	32	6788505R	629,91	6599205R	648,56
32	16	40	6788605R	712,82	6599305R	736,12
40	16	50	6788705R	880,11	6599405R	908,07
50	16	63	6788805R	1.094,24	6599505R	1.138,51
65	10	75	6846105R	2.211,56	6846205R	2.285,25
80	10	90	6846305R	2.982,35	6846405R	3.072,66
100	10	110	6847505R	3.846,47	6847605R	3.946,18

C08 | FAM VAL385

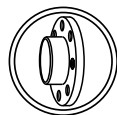
VALVOLE A SFERA PVDF
 flange ANSI-150 in acciaio
 rivestita in PP
 flangia libera (RF)

PVDF BALL VALVE
 PP steel coated ANSI-150 flanges
 loose flange (RF)

DN	PN	D	EPDM	€	FPM	€
15	16	½"	67883AB05R	553,49	65990AB05R	565,15
20	16	¾"	67884AB05R	592,66	65991AB05R	606,29
25	16	1"	67885AB05R	629,91	65992AB05R	648,56
32	16	1¼"	67886AB05R	712,82	65993AB05R	736,12
40	16	1½"	67887AB05R	880,11	65994AB05R	908,07
50	16	2"	67888AB05R	1.094,24	65995AB05R	1.138,51
65	10	2½"	68461AB05R	2.211,56	68462AB05R	2.285,25
80	10	3"	68463AB05R	2.982,35	68464AB05R	3.072,66
100	10	4"	68475AB05R	3.846,47	68476AB05R	3.946,18

PVDF

VALVOLE A SFERA PVDF SERIE EXTREME - ATTUATORE PNEUMATICO DOPPIO EFFETTO
PVDF BALL VALVE EXTREME SERIES - PNEUMATIC ACTUATOR DOUBLE ACTING

rotork

C08 | FAM VAL385

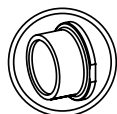

VALVOLE A SFERA PVDF
elettrofusione

PVDF BALL VALVE
socket fusion

DN	PN	D	EPDM	€	FPM	€
10	16	16	6492407R	406,53	6441507R	418,41
15	16	20	6492507R	406,53	6441607R	418,41
20	16	25	6492607R	425,68	6441707R	439,93
25	16	32	6492707R	447,56	6441807R	466,58
32	16	40	6492807R	478,86	6441907R	502,63
40	16	50	6492907R	552,33	6442007R	580,85
50	16	63	6493007R	653,62	6442107R	698,78
65	10	75	6863207R	1.358,44	6826607R	1.432,13
80	10	90	6863307R	1.638,60	6826707R	1.728,92
100	10	110	6932007R	2.172,81	6932107R	2.270,78

C08 | FAM VAL385

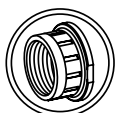

VALVOLE A SFERA PVDF
filetto femmina BSP
rinforzo in acciaio inossidabile

PVDF BALL VALVE
female thread BSP
Stainless steel reinforcement

DN	PN	G	EPDM	€	FPM	€
10	16	3/8"	6624807R	414,49	6631707R	426,37
15	16	1/2"	6624907R	414,49	6631807R	426,37
20	16	3/4"	6625007R	433,99	6631907R	448,26
25	16	1"	6625107R	457,54	6632007R	476,56
32	16	1 1/4"	6625207R	490,51	6632107R	514,28
40	16	1 1/2"	6625307R	566,95	6632207R	595,47
50	16	2"	6625407R	670,86	6632307R	716,00
65	10	2 1/2"	6932207R	1.416,85	6932607R	1.490,53
80	10	3"	6932307R	1.709,87	6932807R	1.800,19
100	10	4"	6932407R	2.250,50	6932907R	2.348,43

C08 | FAM VAL385

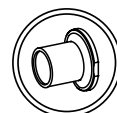

VALVOLE A SFERA PVDF
saldatura di tasca

PVDF BALL VALVE
spigot fusion

DN	PN	D	EPDM	€	FPM	€
15	16	20	6787007R	427,02	6787707R	440,23
20	16	25	6787107R	451,26	6787807R	467,02
25	16	32	6787207R	484,03	6787907R	504,68
32	16	40	6787307R	522,81	6788007R	548,73
40	16	50	6787407R	617,36	6788107R	649,51
50	16	63	6787507R	736,65	6788207R	784,91
65	10	75	7070607R	1.580,89	7071107R	1.666,27
80	10	90	7070807R	1.925,66	7071207R	2.030,33
100	10	110	7070907R	2.594,22	7071307R	2.707,70

Accessori PVC-U

Valvole PVC-U

Accessori PVC-C

Valvole PVC-C

Valvole Extreme

Evacuazione

Ricambi

VALVOLE A SFERA PVDF SERIE EXTREME - ATTUATORE PNEUMATICO DOPPIO EFFETTO
PVDF BALL VALVE EXTREME SERIES - PNEUMATIC ACTUATOR DOUBLE ACTING

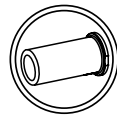

C08 | FAM VAL385

VALVOLE A SFERA PVDF
 saldatura testa a testa
 PVDF / SDR11

PVDF BALL VALVE
 butt fusion
 PVDF / SDR11

DN	PN	D	EPDM	€	FPM	€
15	16	20	6717507R	413,41	6718107R	424,81
20	16	25	6717607R	434,33	6718207R	447,92
25	16	32	6717707R	461,64	6718307R	479,45
32	16	40	6717807R	493,98	6718407R	516,36
40	16	50	6717907R	574,47	6718507R	602,23
50	16	63	6718007R	678,36	6718607R	720,00
65	10	75	6933007R	1.429,19	6933307R	1.502,86
80	10	90	6933107R	1.729,91	6933407R	1.820,23
100	10	110	6933207R	2.306,83	6933607R	2.404,75

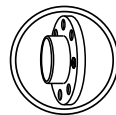
C08 | FAM VAL385

VALVOLE A SFERA PVDF
 flange ISO in acciaio rivestite in PP
 flangia libera (RF)

PVDF BALL VALVE
 PP steel coated ISO flanges
 loose flange (RF)

DN	PN	D	EPDM	€	FPM	€
15	16	20	6788307R	520,51	6599007R	532,16
20	16	25	6788407R	550,92	6599107R	564,55
25	16	32	6788507R	573,19	6599207R	591,82
32	16	40	6788607R	637,97	6599307R	661,26
40	16	50	6788707R	684,02	6599407R	711,97
50	16	63	6788807R	792,37	6599507R	836,64
65	10	75	6846107R	1.664,22	6846207R	1.737,90
80	10	90	6846307R	2.262,55	6846407R	2.352,87
100	10	110	6847507R	3.032,85	6847607R	3.130,12

C08 | FAM VAL385

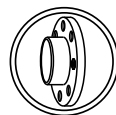
VALVOLE A SFERA PVDF
 flange ANSI-150 in acciaio
 rivestite in PP
 flangia libera (RF)

PVDF BALL VALVE
 PP steel coated ANSI-150 flanges
 loose flange (RF)

DN	PN	D	EPDM	€	FPM	€
15	16	½"	67883AB07R	520,51	65990AB07R	532,16
20	16	¾"	67884AB07R	550,92	65991AB07R	564,55
25	16	1"	67885AB07R	573,19	65992AB07R	591,82
32	16	1¼"	67886AB07R	637,97	65993AB07R	661,26
40	16	1½"	67887AB07R	684,02	65994AB07R	711,97
50	16	2"	67888AB07R	792,37	65995AB07R	836,64
65	10	2½"	68461AB07R	1.664,22	68462AB07R	1.737,90
80	10	3"	68463AB07R	2.262,55	68464AB07R	2.352,87
100	10	4"	68475AB07R	3.032,85	68476AB07R	3.130,12

PVDF

VALVOLE A SFERA PVDF SERIE EXTREME - ATTUATORE ELETTRICO 85-240V AC/DC
PVDF BALL VALVE EXTREME SERIES - ELECTRIC ACTUATION 85-240V AC/DC

J+J

C08 | FAM VAL375



VALVOLE A SFERA PVDF
elettrofusione

PVDF BALL VALVE
socket fusion



DN	PN	D	EPDM		€	FPM		€
			85-240V	24V		85-240V	24V	
10	16	16	6492409J	6492410J	591,90	6441509J	6441510J	603,78
15	16	20	6492509J	6492510J	591,90	6441609J	6441610J	603,78
20	16	25	6492609J	6492610J	607,78	6441709J	6441710J	622,04
25	16	32	6492709J	6492710J	633,04	6441809J	6441810J	652,06
32	16	40	6492809J	6492810J	664,60	6441909J	6441910J	688,37
40	16	50	6492909J *		917,21	6442009J *		945,73
50	16	63	6493009J *		1.053,82	6442109J *		1.098,96
65	10	75	6863209J *		1.685,59	6826609J *		1.759,26
80	10	90	6863309J *		2.186,62	6826709J *		2.276,94
100	10	110	6932009J *		3.109,67	6932109J *		3.207,63

C08 | FAM VAL375



VALVOLE A SFERA PVDF
filetto femmina BSP
rinforzo in acciaio inossidabile

PVDF BALL VALVE
female thread BSP
Stainless steel reinforcement



DN	PN	G	EPDM		€	FPM		€
			85-240V	24V		85-240V	24V	
10	16	3/8"	6624809J	6624810J	599,86	6631709J	6631710J	611,74
15	16	1/2"	6624909J	6624910J	599,86	6631809J	6631810J	611,74
20	16	3/4"	6625009J	6625010J	616,10	6631909J	6631910J	630,36
25	16	1"	6625109J	6625110J	643,01	6632009J	6632010J	662,04
32	16	1 1/4"	6625209J	6625210J	676,25	6632109J	6632110J	700,02
40	16	1 1/2"	6625309J *		931,83	6632209J *		960,35
50	16	2"	6625409J *		1.071,04	6632309J *		1.116,20
65	10	2 1/2"	6932209J *		1.743,99	6932609J *		1.817,67
80	10	3"	6932309J *		2.257,90	6932809J *		2.348,21
100	10	4"	6932409J *		3.187,36	6932909J *		3.285,28

C08 | FAM VAL375



VALVOLE A SFERA PVDF
saldatura di tasca

PVDF BALL VALVE
spigot fusion



DN	PN	D	EPDM		€	FPM		€
			85-240V	24V		85-240V	24V	
15	16	20	6787009J	6787010J	612,39	6787709J	6787710J	625,60
20	16	25	6787109J	6787110J	633,36	6787809J	6787810J	649,12
25	16	32	6787209J	6787210J	669,50	6787909J	6787910J	690,15
32	16	40	6787309J	6787310J	708,55	6788009J	6788010J	734,47
40	16	50	6787409J *		982,23	6788109J *		1.014,38
50	16	63	6787509J *		1.136,84	6788209J *		1.185,10
65	10	75	7070609J *		1.908,04	7071109J *		1.993,42
80	10	90	7070809J *		2.473,69	7071209J *		2.578,36
100	10	110	7070909J *		3.531,07	7071309J *		3.644,55

* Multivoltaggio 24-240V AC/DC

* Multivoltage 24-240V AC/DC

Accessori PVC-U

Valvole PVC-U

Accessori PVC-C

Valvole PVC-C

Valvole Extreme

Evacuazione

Ricambi

PVDF

VALVOLE A SFERA PVDF SERIE EXTREME - ATTUATORE ELETTRICO 85-240V AC/DC
PVDF BALL VALVE EXTREME SERIES - ELECTRIC ACTUATION 85-240V AC/DC

C08 | FAM VAL375

VALVOLE A SFERA PVDF
 saldatura testa a testa
 PVDF / SDR11

PVDF BALL VALVE
 butt fusion
 PVDF / SDR11

DN	PN	D	EPDM		€	FPM		€
			85-240V	24V		85-240V	24V	
15	16	20	6717509J	6717510J	598,78	6718109J	6718110J	610,19
20	16	25	6717609J	6717610J	616,44	6718209J	6718210J	630,04
25	16	32	6717709J	6717710J	647,12	6718309J	6718310J	664,93
32	16	40	6717809J	6717810J	679,72	6718409J	6718410J	702,08
40	16	50	6717909J *		939,35	6718509J *		967,11
50	16	63	6718009J *		1.078,55	6718609J *		1.120,19
65	10	75	6933009J *		1.756,33	6933309J *		1.830,00
80	10	90	6933109J *		2.277,94	6933409J *		2.368,24
100	10	110	6933209J *		3.243,69	6933609J *		3.341,61

C08 | FAM VAL375

VALVOLE A SFERA PVDF
 flange ISO in acciaio rivestite in PP
 flangia libera (RF)

PVDF BALL VALVE
 PP steel coated ISO flanges
 loose flange (RF)

DN	PN	D	EPDM		€	FPM		€
			85-240V	24V		85-240V	24V	
15	16	20	6788309J	6788310J	705,89	6599009J	6599010J	717,54
20	16	25	6788409J	6788410J	733,02	6599109J	6599110J	746,65
25	16	32	6788509J	6788510J	758,67	6599209J	6599210J	777,30
32	16	40	6788609J	6788610J	823,70	6599309J	6599310J	847,00
40	16	50	6788709J *		1.048,90	6599409J *		1.076,86
50	16	63	6788809J *		1.192,56	6599509J *		1.236,83
65	10	75	6846109J *		1.991,36	6846209J *		2.065,03
80	10	90	6846309J *		2.810,57	6846409J *		2.900,89
100	10	110	6847509J *		3.969,70	6847609J *		4.066,97

C08 | FAM VAL375

VALVOLE A SFERA PVDF
 flange ANSI-150 in acciaio
 rivestite in PP
 flangia libera (RF)

PVDF BALL VALVE
 PP steel coated ANSI-150 flanges
 loose flange (RF)

DN	PN	D	EPDM		€	FPM		€
			85-240V	24V		85-240V	24V	
15	16	½"	67883AB09J	67883AB10J	705,89	65990AB09J	65990AB10J	717,54
20	16	¾"	67884AB09J	67884AB10J	733,02	65991AB09J	65991AB10J	746,65
25	16	1"	67885AB09J	67885AB10J	758,67	65992AB09J	65992AB10J	777,30
32	16	1¼"	67886AB09J	67886AB10J	823,70	65993AB09J	65993AB10J	847,00
40	16	1½"	67887AB09J *		1.048,90	65994AB09J *		1.076,86
50	16	2"	67888AB09J *		1.192,56	65995AB09J *		1.236,83
65	10	2½"	68461AB09J *		1.991,36	68462AB09J *		2.065,03
80	10	3"	68463AB09J *		2.810,57	68464AB09J *		2.900,89
100	10	4"	68475AB09J *		3.969,70	68476AB09J *		4.066,97

* Multivoltaggio 24-240V AC/DC

* Multivoltage 24-240V AC/DC

ABS

VALVOLE A SFERA ABS SERIE EXTREME - ATTUATORE PNEUMATICO SEMPLICE EFFETTO (NC)
ABS BALL VALVE EXTREME SERIES - PNEUMATIC ACTUATOR SPRING RETURN (NC)

rotork

C08 | FAM VAL385

Accessori PVC-U

Valvole PVC-U

Accessori PVC-C

Valvole PVC-C

Valvole Extreme

Evacuazione

Ricambi



VALVOLE A SFERA ABS
incollaggio femmina ISO/DIN

ABS BALL VALVE
metric solvent socket ISO/DIN



DN	PN	D	EPDM	€	FPM	€
10	10	16	6518705R	418,24	6519405R	430,12
15	10	20	6518805R	418,24	6519505R	430,12
20	10	25	6518905R	436,87	6519605R	451,13
25	10	32	6519005R	461,98	6519705R	480,99
32	10	40	6519105R	491,92	6519805R	515,69
40	10	50	6519205R	632,79	6519905R	661,32
50	10	63	6519305R	779,61	6520005R	824,76
65	6	75	6863405R	1.372,18	6863705R	1.445,85
80	6	90	6863505R	1.658,12	6863805R	1.748,44
100	6	110	6863605R	1.884,64	6863905R	1.984,94

C08 | FAM VAL385

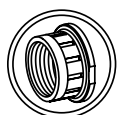

VALVOLE A SFERA ABS
filetto femmina BSP
rinforzo in acciaio inossidabile

ABS BALL VALVE
female thread BSP
Stainless steel reinforcement



DN	PN	G	EPDM	€	FPM	€
10	10	3/8"	6520105R	426,20	6521405R	438,09
15	10	1/2"	6520205R	426,20	6520805R	438,09
20	10	3/4"	6520305R	445,19	6520905R	459,45
25	10	1"	6520405R	471,96	6521005R	490,98
32	10	1 1/4"	6520505R	503,56	6521105R	527,33
40	10	1 1/2"	6520605R	647,41	6521205R	675,94
50	10	2"	6520705R	796,48	6521305R	841,64
65	6	2 1/2"	6949005R	1.392,85	6949305R	1.466,54
80	6	3"	6949105R	1.681,53	6949405R	1.771,85
100	6	4"	6949205R	1.902,80	6949605R	2.003,10

C08 | FAM VAL385

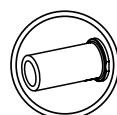

VALVOLE A SFERA ABS
saldatura testa a testa
PE100 / SDR11

ABS BALL VALVE
butt welding
PE100 / SDR11



DN	PN	D	EPDM	€	FPM	€
15	10	20	6789005R	422,63	6789705R	434,52
20	10	25	6789105R	442,09	6789805R	456,36
25	10	32	6789205R	470,18	6789905R	489,19
32	10	40	6789305R	500,24	6790005R	524,01
40	10	50	6789405R	643,85	6790105R	672,37
50	10	63	6789505R	789,83	6790205R	834,99
65	6	75	6949705R	1.393,73	6950005R	1.467,40
80	6	90	6949805R	1.685,20	6950105R	1.775,52
100	6	110	6949905R	1.923,75	6950205R	2.024,07

Per attuatori SE - NA, Consultare

For SR - NO actuator, ask for the code

ABS

VALVOLE A SFERA ABS SERIE EXTREME - ATTUATORE PNEUMATICO DOPPIO EFFETTO
ABS BALL VALVE EXTREME SERIES - PNEUMATIC ACTUATOR DOUBLE ACTING

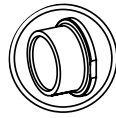
 C08 | FAM VAL385

VALVOLE A SFERA ABS
 incollaggio femmina ISO/DIN

ABS BALL VALVE
 metric solvent socket ISO/DIN

DN	PN	D	EPDM	€	FPM	€
10	10	16	6518707R	385,25	6519407R	397,14
15	10	20	6518807R	385,25	6519507R	397,14
20	10	25	6518907R	395,13	6519607R	409,39
25	10	32	6519007R	405,26	6519707R	424,27
32	10	40	6519107R	417,06	6519807R	440,83
40	10	50	6519207R	436,70	6519907R	465,22
50	10	63	6519307R	477,74	6520007R	522,89
65	6	75	6863407R	824,83	6863707R	898,50
80	6	90	6863507R	938,33	6863807R	1.028,64
100	6	110	6863607R	1.118,86	6863907R	1.216,73

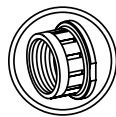
C08 | FAM VAL385

VALVOLE A SFERA ABS
 filetto femmina BSP
 rinforzo in acciaio inossidabile

ABS BALL VALVE
 female thread BSP
 Stainless steel reinforcement

DN	PN	G	EPDM	€	FPM	€
10	10	3/8"	6520107R	393,22	6521407R	405,10
15	10	1/2"	6520207R	393,22	6520807R	405,10
20	10	3/4"	6520307R	403,45	6520907R	417,71
25	10	1"	6520407R	415,24	6521007R	434,25
32	10	1 1/4"	6520507R	428,71	6521107R	452,48
40	10	1 1/2"	6520607R	451,32	6521207R	479,84
50	10	2"	6520707R	494,61	6521307R	539,77
65	6	2 1/2"	6949007R	845,51	6949307R	919,19
80	6	3"	6949107R	961,73	6949407R	1.052,05
100	6	4"	6949207R	1.136,58	6949607R	1.234,45

C08 | FAM VAL385

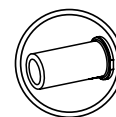
VALVOLE A SFERA ABS
 saldatura testa a testa
 PE100 / SDR11

ABS BALL VALVE
 butt welding
 PE100 / SDR11

DN	PN	D	EPDM	€	FPM	€
15	10	20	6789007R	389,65	6789707R	401,53
20	10	25	6789107R	400,35	6789807R	414,62
25	10	32	6789207R	413,45	6789907R	432,47
32	10	40	6789307R	425,39	6790007R	449,16
40	10	50	6789407R	447,75	6790107R	476,27
50	10	63	6789507R	487,96	6790207R	533,12
65	6	75	6949707R	846,38	6950007R	920,07
80	6	90	6949807R	965,40	6950107R	1.055,71
100	6	110	6949907R	1.157,03	6950207R	1.254,90

ABS

VALVOLE A SFERA ABS SERIE EXTREME - ATTUATORE ELETTRICO 85-240V AC/DC
ABS BALL VALVE EXTREME SERIES - ELECTRIC ACTUATOR 85-240V AC/DC

C08 | FAM VAL375



Accessori PVC-U

Valvole PVC-U

Accessori PVC-C

Valvole PVC-C

Valvole Extreme

Evacuazione

Ricambi:



VALVOLE A SFERA ABS
incollaggio femmina ISO/DIN

ABS BALL VALVE
metric solvent socket ISO/DIN

DN	PN	D	EPDM		€	FPM		€
			85-240V	24V		85-240V	24V	
10	16	16	6518709J	6518710J	570,63	6519409J	6519410J	582,51
15	16	20	6518809J	6518810J	570,63	6519509J	6519510J	582,51
20	16	25	6518909J	6518910J	577,24	6519609J	6519610J	591,50
25	16	32	6519009J	6519010J	590,74	6519709J	6519710J	609,75
32	16	40	6519109J	6519110J	602,80	6519809J	6519810J	626,57
40	16	50	6519209J *		801,58	6519909J *		830,10
50	16	63	6519309J *		877,93	6520009J *		923,09
65	10	75	6863409J *		1.151,97	6863709J *		1.225,64
80	10	90	6863509J *		1.486,35	6863809J *		1.576,66
100	10	110	6863609J *		2.055,72	6863909J *		2.153,58

C08 | FAM VAL375



VALVOLE A SFERA ABS
filetto femmina BSP
rinforzo in acciaio inossidabile

ABS BALL VALVE
female thread BSP
Stainless steel reinforcement

DN	PN	G	EPDM		€	FPM		€
			85-240V	24V		85-240V	24V	
10	16	3/8"	6520109J	6520110J	578,59	6521409J	6521410J	590,47
15	16	1/2"	6520209J	6520210J	578,59	6520809J	6520810J	590,47
20	16	3/4"	6520309J	6520310J	585,55	6520909J	6520910J	599,82
25	16	1"	6520409J	6520410J	600,72	6521009J	6521010J	619,73
32	16	1 1/4"	6520509J	6520510J	614,44	6521109J	6521110J	638,21
40	16	1 1/2"	6520609J *		816,20	6521209J *		844,72
50	16	2"	6520709J *		894,81	6521309J *		939,97
65	10	2 1/2"	6949009J *		1.172,65	6949309J *		1.246,33
80	10	3"	6949109J *		1.509,76	6949409J *		1.600,07
100	10	4"	6949209J *		2.073,44	6949609J *		2.171,31

C08 | FAM VAL375



VALVOLE A SFERA ABS
saldatura testa a testa
PE100 / SDR11

ABS BALL VALVE
butt welding
PE100 / SDR11

DN	PN	D	EPDM		€	FPM		€
			85-240V	24V		85-240V	24V	
15	16	20	6789009J	6789010J	575,03	6789709J	6789710J	586,91
20	16	25	6789109J	6789110J	582,47	6789809J	6789810J	596,72
25	16	32	6789209J	6789210J	598,93	6789909J	6789910J	617,95
32	16	40	6789309J	6789310J	611,12	6790009J	6790010J	634,89
40	16	50	6789409J *		812,63	6790109J *		841,15
50	16	63	6789509J *		888,15	6790209J *		933,31
65	10	75	6949709J *		1.173,52	6950009J *		1.247,20
80	10	90	6949809J *		1.513,42	6950109J *		1.603,74
100	10	110	6949909J *		2.093,88	6950209J *		2.191,76

* Multivoltaggio 24-240V AC/DC

* Multivoltage 24-240V AC/DC

VALVOLE A FARFALLA CON ATTUAZIONE PNEUMATICA BUTTERFLY VALVES WITH PNEUMATIC ACTUATION



Attuazione pneumatica disponibile per tutte le versioni delle valvole a farfalla Serie Extreme.

Modello base: Rotork modelo GT.

Possibilità di configurazione con altri modelli e marchi. Può essere impiegato anche come dispositivo singolo per l'esercizio di altri organi di regolazione da parte del cliente.

Opzioni di attuazione:

- SEMPLICE EFFETTO con valvola normalmente chiusa (SE - NC).
- SEMPLICE EFFETTO con valvola normalmente aperta (SE - NA).
- DOPPIO EFFETTO (DA).

Accessori opzionali:

- Box finecorsa.
- Elettrovalvola di comando (in differenti configurazioni).
- Silenziatore di sfogo aria.
- Posizionatore elettropneumatico.

Pneumatic actuation possibility in all versions of the butterfly valve Extreme Series.

Default actuator: Rotork GT model.

Possibility of actuation using other brands or models, or preparing the valve for customer own actuation.

Actuation options

- Spring return with normally closed valve (NC).
- Spring return with normally open valve (NO).
- Double acting (DA).

Optional accessories:

- Limit switch box.
- Solenoid valve (different configurations).
- Relief regulators.
- Electropneumatic positioner.

Rotork GT - Caratteristiche standard:

- Attuatore a pistone.
- Design leggero e compatto.
- Corpo in alluminio anodizzato.
- Garantisce nel lungo periodo la massima efficienza ed una manutenzione minima.

Actuator characteristics - Rotork GT:

- Piston drive.
- Compact design and lightweight.
- Housed in anodised aluminium.
- Long and efficient service with a minimum maintenance.



VALVOLE A FARFALLA CON ATTUAZIONE ELETTRICA BUTTERFLY VALVES WITH ELECTRIC ACTUATION



Attuazione elettrica disponibile per tutte le versioni delle valvole a farfalla Serie Extreme.

Modello base: J+J.

Possibilità di configurazione con altri modelli e marchi. Può essere impiegato anche come dispositivo singolo per l'esercizio di altri organi di regolazione da parte del cliente.

Opzioni di attuazione:

- Multivoltaggio (24-240 VAC/VDC).

Accessori opzionali:

- BSR - Blocco di sicurezza.
- DPS - Posizionatore digitale.

Electric actuation possibility in all versions of the butterfly valve Extreme Series.

Default actuator: J+J.

Possibility of actuation using other brands or models, or preparing the valve for customer own actuation.

Actuation options

- Multivoltage (24-240 VAC/VDC).

Optional accessories:

- BSR - Safety block.
- DPS - Digital positioner.

J+J - Caratteristiche standard:

- Controllo elettronico della rotazione con limitazione di coppia.
- Resistenza interna anticondensa.
- Selettore automatico/manuale, con comando manuale di emergenza.
- Segnalatore di apertura e chiusura tramite contatto pulito (libero da tensione).
- Indicatore a LED delle operazioni/errori di segnalazione.
- Corpo esterno in poliammide anticorrosivo.

Actuator characteristics J+J:

- Electronic torque control, with limitation of maximum torque
- Anti-condensation heating resistor
- Automatic / manual lever, with manual override
- Open and closed volt free contacts
- Indicator LED operating / error
- Enclosure in antricorrosive polyamide



KIT DI ATTUAZIONE
ACTUATION KIT

Alfanum. | C08

Il kit include tutti i componenti necessari per connettere le valvole a farfalla con l'attuatore ed è compatibile con tutti i modelli di marchi che rispettano la normativa ISO 5211.

Componenti: bussola di connessione, bulloneria e supporto di fissaggio.

The kit includes all the necessary elements to connect the butterfly valve with the actuator and it is ready for all the brands of actuators following the ISO 5211 regulation.

Components: coupling bush, supports, bolts, mounting clamp and connectors.

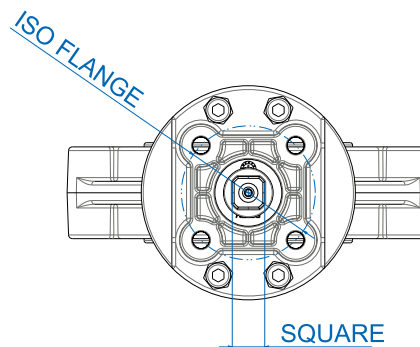

D	DN	ISO FLANGE F05		ISO FLANGE F07			ISO FLANGE F10			ISO FLANGE F12		
		Q14	Q17	Q14	Q17	Q22	Q27	Q17	Q22	Q27	Q22	Q27
50	40			69507	69508	On request	On request	On request	On request	On request	On request	On request
				41,16 €	41,16 €							
75	65			65424	65425							
				41,16 €	41,16 €							
90	80	66050*		66065	65426							
		73,45 €		41,16 €	41,16 €							
110	100	68492*		66066	65427	65880						
		73,45 €		41,16 €	41,16 €	57,50 €						
125-140	125				65428	65429						
					46,61 €	46,61 €						
160	150				65430	65431						
					46,61 €	46,61 €						
200-225	200				65432	65433		65434	65435	66064		
					64,10 €	64,10 €		64,10 €	64,10 €	64,10 €		
250	250					65436	65437		65438	65439	65441	65442
						74,19 €	74,19 €		74,19 €	74,19 €	74,19 €	74,19 €
315	300					65443	65444		65445	65446	65447	65448
						74,19 €	74,19 €		74,19 €	74,19 €	74,19 €	74,19 €

* Configurazione speciale con morsetto separatore in acciaio inossidabile.

* Special configuration with mounting clamp made in Stainless Steel.

PVC-U

VALVOLE A FARFALLA PVC-U SERIE EXTREME - ATTUATORE PNEUMATICO SEMPLICE EFFETTO (NC)
PVC-U BUTTERFLY VALVE EXTREME SERIES - PNEUMATIC ACTUATOR SPRING RETURN (NC)



C08 | FAM VMA545



VALVOLE A FARFALLA PVC-U
Corpo in PP - GR
Lente in PVC-U

PVC-U BUTTERFLY VALVE
Body in PP - GR
Disc in PVC-U

DN	PN	D	EPDM	€	FPM	€
40	10	50	6672505R	719,48	6672605R	818,72
65	10	63-75	6136505R	866,11	6146005R	990,17
80	10	90	6136605R	1.032,18	6146105R	1.167,37
100	10	110	6136705R	1.169,45	6146205R	1.355,12
125	10	125-140	6136805R	1.701,06	6146305R	1.956,90
150	10	160	6136905R	1.780,61	6146405R	2.074,10
200	10	200-225	6137005R	2.319,44	6146505R	2.825,97
250	6	250	6147205R	3.222,54	6148005R	4.230,76
300	6	315	6147305R	4.813,12	6148105R	6.073,75

VALVOLE A FARFALLA PVC-U SERIE EXTREME - ATTUATORE PNEUMATICO DOPPIO EFFETTO
PVC-U BUTTERFLY VALVE EXTREME SERIES - PNEUMATIC ACTUATOR DOUBLE ACTING

C08 | FAM VMA545



VALVOLE A FARFALLA PVC-U
Corpo in PP - GR
Lente in PVC-U

PVC-U BUTTERFLY VALVE
Body in PP - GR
Disc in PVC-U

DN	PN	D	EPDM	€	FPM	€
40	10	50	6672507R	559,26	6672607R	658,50
65	10	63-75	6136507R	617,78	6146007R	741,85
80	10	90	6136607R	700,12	6146107R	835,31
100	10	110	6136707R	758,34	6146207R	944,03
125	10	125-140	6136807R	997,57	6146307R	1.253,40
150	10	160	6136907R	1.154,24	6146407R	1.447,73
200	10	200-225	6137007R	1.495,96	6146507R	2.002,50
250	6	250	6147207R	2.286,94	6148007R	3.295,16
300	6	315	6147307R	2.847,67	6148107R	4.108,30

VALVOLE A FARFALLA PVC-U SERIE EXTREME - ATTUATORE ELETTRICO 24-240V AC/DC
PVC-U BUTTERFLY VALVE EXTREME SERIES - ELECTRIC ACTUATOR 24-240V AC/C



C08 | FAM VMA535



VALVOLE A FARFALLA PVC-U
Corpo in PP - GR
Lente in PVC-U

PVC-U BUTTERFLY VALVE
Body in PP - GR
Disc in PVC-U

DN	PN	D	EPDM	€	FPM	€
40	10	50	6672509J	930,12	6672609J	1.029,37
65	10	63-75	6136509J	1.281,44	6146009J	1.405,51
80	10	90	6136609J	1.339,87	6146109J	1.475,07
100	10	110	6136709J	1.674,26	6146209J	1.859,93
125	10	125-140	6136809J	2.270,00	6146309J	2.525,83
150	10	160	6136909J	2.304,84	6146409J	2.598,31
200	10	200-225	6137009J	3.007,72	6146509J	3.514,25
250	6	250	6147209J	3.931,43	6148009J	4.939,65
300	6	315	6147309J	4.326,52	6148109J	5.587,14

Per attuatori SE - NA, Consultare

Tutte le configurazioni delle valvole a farfalla sono disponibili in VERSIONE LUG

For SR - NO actuator, ask for the code

All the butterfly valve configurations are available in LUG type

PVC-C

VALVOLE A FARFALLA PVC-C SERIE EXTREME - ATTUATORE PNEUMATICO SEMPLICE EFFETTO (NC)
CPVC BUTTERFLY VALVE EXTREME SERIES - PNEUMATIC ACTUATOR SPRING RETURN (NC)

C08 | FAM VMA545

**VALVOLE A FARFALLA PVC-C**Corpo in PP - GR
Lente in PVC-C**CPVC BUTTERFLY VALVE**Body in PP - GR
Disc in CPVC

DN	PN	D	EPDM	€	FPM	€
40	10	50	6673405R	744,81	6673505R	844,05
65	10	63-75	6149805R	897,76	6150405R	1.021,84
80	10	90	6149905R	1.065,69	6150505R	1.200,88
100	10	110	6150005R	1.211,51	6150605R	1.397,18
125	10	125-140	6150105R	1.757,68	6150705R	2.013,51
150	10	160	6150205R	1.857,05	6150805R	2.150,53
200	10	200-225	6150305R	2.456,63	6150905R	2.963,16
250	6	250	6151605R	3.317,09	6152405R	4.325,31
300	6	315	6151705R	4.961,44	6152505R	6.222,07

VALVOLE A FARFALLA PVC-C SERIE EXTREME - ATTUATORE PNEUMATICO DOPPIO EFFETTO
CPVC BUTTERFLY VALVE EXTREME SERIES - PNEUMATIC ACTUATOR DOUBLE ACTING

C08 | FAM VMA545

**VALVOLE A FARFALLA PVC-C**Corpo in PP - GR
Lente in PVC-C**CPVC BUTTERFLY VALVE**Body in PP - GR
Disc in CPVC

DN	PN	D	EPDM	€	FPM	€
40	10	50	6673407R	584,59	6673507R	683,83
65	10	63-75	6149807R	649,43	6150407R	773,51
80	10	90	6149907R	733,63	6150507R	868,82
100	10	110	6150007R	800,42	6150607R	986,09
125	10	125-140	6150107R	1.054,18	6150707R	1.310,01
150	10	160	6150207R	1.230,68	6150807R	1.524,16
200	10	200-225	6150307R	1.633,15	6150907R	2.139,69
250	6	250	6151607R	2.381,49	6152407R	3.389,71
300	6	315	6151707R	2.995,99	6152507R	4.256,61

VALVOLE A FARFALLA PVC-C SERIE EXTREME - ATTUATORE ELETTRICO 24-240V AC/DC
CPVC BUTTERFLY VALVE EXTREME SERIES - ELECTRIC ACTUATOR 24-240V AC/DC

C08 | FAM VMA535

**VALVOLE A FARFALLA PVC-C**Corpo in PP - GR
Lente in PVC-C**CPVC BUTTERFLY VALVE**Body in PP - GR
Disc in CPVC

DN	PN	D	EPDM	€	FPM	€
40	10	50	6673409J	955,45	6673509J	1.054,71
65	10	63-75	6149809J	1.313,10	6150409J	1.437,16
80	10	90	6149909J	1.373,38	6150509J	1.508,58
100	10	110	6150009J	1.716,33	6150609J	1.902,01
125	10	125-140	6150109J	2.326,61	6150709J	2.582,44
150	10	160	6150209J	2.381,26	6150809J	2.674,75
200	10	200-225	6150309J	3.144,91	6150909J	3.651,44
250	6	250	6151609J	4.025,98	6152409J	5.034,20
300	6	315	6151709J	4.474,83	6152509J	5.735,46

Per attuatori SE - NA, Consultare

For SR - NO actuator, ask for the code

Tutte le configurazioni delle valvole a farfalla sono disponibili in VERSIONE LUG

All the butterfly valve configurations are available in LUG type

PP-H

VALVOLE A FARFALLA PP-H SERIE EXTREME - ATTUATORE PNEUMATICO SEMPLICE EFFETTO (NC)
PP-H BUTTERFLY VALVE EXTREME SERIES - PNEUMATIC ACTUATOR SPRING RETURN (NC)



C08 | FAM VMA545



VALVOLE A FARFALLA PP-H

Corpo in PP - GR
Lente in PP-H

PP-H BUTTERFLY VALVE

Body in PP - GR
Disc in PP-H

DN	PN	D	EPDM	€	FPM	€
40	10	50	6673805R	719,48	6673905R	818,72
65	10	63-75	6154205R	866,11	6196205R	990,17
80	10	90	6154305R	1.032,18	6196305R	1.167,37
100	10	110	6154405R	1.169,45	6196405R	1.355,12
125	10	125-140	6154505R	1.701,06	6196505R	1.956,90
150	10	160	6154605R	1.780,61	6196605R	2.074,10
200	10	200-225	6154905R	2.319,44	6196705R	2.825,97
250	6	250	6197405R	3.222,54	6198205R	4.230,76
300	6	315	6197505R	4.813,12	6198305R	6.073,75

VALVOLE A FARFALLA PP-H SERIE EXTREME - ATTUATORE PNEUMATICO DOPPIO EFFETTO
PP-H BUTTERFLY VALVE EXTREME SERIES - PNEUMATIC ACTUATOR DOUBLE ACTING

C08 | FAM VMA545



VALVOLE A FARFALLA PP-H

Corpo in PP - GR
Lente in PP-H

PP-H BUTTERFLY VALVE

Body in PP - GR
Disc in PP-H

DN	PN	D	EPDM	€	FPM	€
40	10	50	6673807R	559,26	6673907R	658,50
65	10	63-75	6154207R	617,78	6196207R	741,85
80	10	90	6154307R	700,12	6196307R	835,31
100	10	110	6154407R	758,34	6196407R	944,03
125	10	125-140	6154507R	997,57	6196507R	1.253,40
150	10	160	6154607R	1.154,24	6196607R	1.447,73
200	10	200-225	6154907R	1.495,96	6196707R	2.002,50
250	6	250	6197407R	2.286,94	6198207R	3.295,16
300	6	315	6197507R	2.847,67	6198307R	4.108,30

VALVOLE A FARFALLA PP-H SERIE EXTREME - ATTUATORE ELETTRICO 24-240V AC/DC
PP-H BUTTERFLY VALVE EXTREME SERIES - ELECTRIC ACTUATOR 24-240V AC/DC



C08 | FAM VMA535



VALVOLE A FARFALLA PP-H

Corpo in PP - GR
Lente in PP-H

PP-H BUTTERFLY VALVE

Body in PP - GR
Disc in PP-H

DN	PN	D	EPDM	€	FPM	€
40	10	50	6673809J	930,12	6673909J	1.029,37
65	10	63-75	6154209J	1.281,44	6196209J	1.405,51
80	10	90	6154309J	1.339,87	6196309J	1.475,07
100	10	110	6154409J	1.674,26	6196409J	1.859,93
125	10	125-140	6154509J	2.270,00	6196509J	2.525,83
150	10	160	6154609J	2.304,84	6196609J	2.598,31
200	10	200-225	6154909J	3.007,72	6196709J	3.514,25
250	6	250	6197409J	3.931,43	6198209J	4.939,65
300	6	315	6197509J	4.326,52	6198309J	5.587,14

Per attuatori SE - NA, Consultare

For SR - NO actuator, ask for the code

Tutte le configurazioni delle valvole a farfalla sono disponibili in VERSIONE LUG

All the butterfly valve configurations are available in LUG type

Accessori PVC-U

Valvole PVC-U

Accessori PVC-C

Valvole PVC-C

Valvole Extreme

Evacuazione

Ricambi

PVDF

VALVOLE A FARFALLA PVDF SERIE EXTREME - ATTUATORE PNEUMATICO SEMPLICE EFFETTO (NC)
PVDF BUTTERFLY VALVE EXTREME SERIES - PNEUMATIC ACTUATOR SPRING RETURN (NC)

C08 | FAM VMA545

**VALVOLE A FARFALLA PVDF**Corpo in PP - GR
Lente in PVDF**PVDF BUTTERFLY VALVE**Body in PP - GR
Disc in PVDF

DN	PN	D	EPDM	€	FPM	€
40	10	50	6674405R	754,51	6674505R	853,76
65	10	63-75	6463405R	909,88	6204705R	1.033,96
80	10	90	6463505R	1.082,38	6204805R	1.217,56
100	10	110	6463605R	1.245,31	6204905R	1.430,98
125	10	125-140	6463705R	1.829,83	6205005R	2.085,66
150	10	160	6463805R	1.962,01	6205105R	2.255,50
200	10	200-225	6463905R	2.699,63	6205205R	3.206,17
250	6	250	6464605R	3.881,95	6205905R	4.890,17
300	6	315	6464705R	5.911,18	6206005R	7.171,82

VALVOLE A FARFALLA PVDF SERIE EXTREME - ATTUATORE PNEUMATICO DOPPIO EFFETTO
PVDF BUTTERFLY VALVE EXTREME SERIES - PNEUMATIC ACTUATOR DOUBLE ACTING

C08 | FAM VMA545

**VALVOLE A FARFALLA PVDF**Corpo in PP - GR
Lente in PVDF**PVDF BUTTERFLY VALVE**Body in PP - GR
Disc in PVDF

DN	PN	D	EPDM	€	FPM	€
40	10	50	6674407R	594,29	6674507R	693,53
65	10	63-75	6463407R	661,56	6204707R	785,63
80	10	90	6463507R	750,32	6204807R	885,50
100	10	110	6463607R	834,22	6204907R	1.019,89
125	10	125-140	6463707R	1.126,34	6205007R	1.382,18
150	10	160	6463807R	1.335,64	6205107R	1.629,12
200	10	200-225	6463907R	1.876,16	6205207R	2.382,69
250	6	250	6464607R	2.946,35	6205907R	3.954,57
300	6	315	6464707R	3.945,74	6206007R	5.206,37

VALVOLE A FARFALLA PVDF SERIE EXTREME - ATTUATORE ELETTRICO 24-240V AC/DC
PVDF BUTTERFLY VALVE EXTREME SERIES - ELECTRIC ACTUATOR 24-240V AC/DC

C08 | FAM VMA535

**VALVOLE A FARFALLA PVDF**Corpo in PP - GR
Lente in PVDF**PVDF BUTTERFLY VALVE**Body in PP - GR
Disc in PVDF

DN	PN	D	EPDM	€	FPM	€
40	10	50	6674409J	965,16	6674509J	1.064,40
65	10	63-75	6463409J	1.325,22	6204709J	1.449,28
80	10	90	6463509J	1.390,06	6204809J	1.525,26
100	10	110	6463609J	1.750,13	6204909J	1.935,81
125	10	125-140	6463709J	2.398,77	6205009J	2.654,61
150	10	160	6463809J	2.486,22	6205109J	2.779,71
200	10	200-225	6463909J	3.387,91	6205209J	3.894,44
250	6	250	6464609J	4.590,84	6205909J	5.599,06
300	6	315	6464709J	5.424,58	6206009J	6.685,21

Per attuatori SE - NA, Consultare

For SR - NO actuator, ask for the code

Tutte le configurazioni delle valvole a farfalla sono disponibili in VERSIONE LUG

All the butterfly valve configurations are available in LUG type

ABS

VALVOLE A FARFALLA ABS SERIE EXTREME - ATTUATORE PNEUMATICO SEMPLICE EFFETTO (NC)
ABS BUTTERFLY VALVE EXTREME SERIES - PNEUMATIC ACTUATOR SPRING RETURN (NC)



C08 | FAM VMA545



VALVOLE A FARFALLA ABS

Corpo in PP - GR
Lente in ABS

ABS BUTTERFLY VALVE

Body in PP - GR
Disc in ABS

DN	PN	D	EPDM	€	FPM	€
40	10	50	6675005R	744,81	6675105R	844,05
65	10	63-75	6206905R	897,76	6207505R	1.021,84
80	10	90	6207005R	1.065,69	6207605R	1.200,88
100	10	110	6207105R	1.211,51	6207705R	1.397,18
125	10	125-140	6207205R	1.757,68	6207805R	2.013,51
150	10	160	6207305R	1.857,05	6207905R	2.150,53
200	10	200-225	6207405R	2.456,63	6208005R	2.963,16
250	6	250	6208705R	3.317,09	6209505R	4.325,31
300	6	315	6208805R	4.961,44	6209605R	6.222,07

VALVOLE A FARFALLA ABS SERIE EXTREME - ATTUATORE PNEUMATICO DOPPIO EFFETTO
ABS BUTTERFLY VALVE EXTREME SERIES - PNEUMATIC ACTUATOR DOUBLE ACTING

C08 | FAM VMA545



VALVOLE A FARFALLA ABS

Corpo in PP - GR
Lente in ABS

ABS BUTTERFLY VALVE

Body in PP - GR
Disc in ABS

DN	PN	D	EPDM	€	FPM	€
40	10	50	6675007R	584,59	6675107R	683,83
65	10	63-75	6206907R	649,43	6207507R	773,51
80	10	90	6207007R	733,63	6207607R	868,82
100	10	110	6207107R	800,42	6207707R	986,09
125	10	125-140	6207207R	1.054,18	6207807R	1.310,01
150	10	160	6207307R	1.230,68	6207907R	1.524,16
200	10	200-225	6207407R	1.633,15	6208007R	2.139,69
250	6	250	6208707R	2.381,49	6209507R	3.389,71
300	6	315	6208807R	2.995,99	6209607R	4.256,61

VALVOLE A FARFALLA ABS SERIE EXTREME - ATTUATORE ELETTRICO 24-240V AC/DC
ABS BUTTERFLY VALVE EXTREME SERIES - ELECTRIC ACTUATOR 24-240V AC/DC



C08 | FAM VMA535



VALVOLE A FARFALLA ABS

Corpo in PP - GR
Lente in ABS

ABS BUTTERFLY VALVE

Body in PP - GR
Disc in ABS

DN	PN	D	EPDM	€	FPM	€
40	10	50	6675009J	955,45	6675109J	1.054,71
65	10	63-75	6206909J	1.313,10	6207509J	1.437,16
80	10	90	6207009J	1.373,39	6207609J	1.508,58
100	10	110	6207109J	1.716,33	6207709J	1.902,01
125	10	125-140	6207209J	2.326,61	6207809J	2.582,44
150	10	160	6207309J	2.381,26	6207909J	2.674,75
200	10	200-225	6207409J	3.144,91	6208009J	3.651,44
250	6	250	6208709J	4.025,98	6209509J	5.034,20
300	6	315	6208809J	4.474,83	6209609J	5.735,46

Per attuatori SE - NA, Consultare

For SR - NO actuator, ask for the code

Tutte le configurazioni delle valvole a farfalla sono disponibili in VERSIONE LUG

All the butterfly valve configurations are available in LUG type

ACCESSORI VALVOLE ATTUATI - ACCESSORIES ACTUATED VALVES

C08

**ELETTROVALVOLA**

per attuatori pneumatici
 Configurazione disponibile: 3/2 o 5/2

Brand: SMC
 Da montare direttamente sull'attuatore (NAMUR)

SOLENOID VALVE

for pneumatic actuators
 Configuration 3/2 or 5/2

Brand: SMC
 Direct assembly to the actuator (NAMUR)

Voltage	CODE	€
3/2 - 24 VAC	70734	126,50
3/2 - 24 VDC	70729	126,50
3/2 - 220 VAC	70731	126,50
5/2 - 24 VAC	70732	141,10
5/2 - 24 VDC	70733	141,10
5/2 - 220 VAC	70735	141,10

C08

**SILENZIATORE DI SFIATO ARIA**

per attuatori pneumatici

RELIEF REGULATORS

for pneumatic actuators

	CODE	€
1 UNITÀ - 1 UNIT (solenoid 3/2)	70735	15,43
2 UNITÀ - 2 UNITS (solenoid 5/2)	30745	30,26

C08

**BOX FINECORSA**

per attuatori pneumatici

Brand: Eurotec
 Connessione plug & play
 Uscita elettronica
 Indicatore visuale di posizione

Attuatore DE - Tutti i diametri
 Attuatore SE ≤DN150

LIMIT SWITCH BOX

for pneumatic actuators

Brand: Eurotec
 Plug & play connection
 Electronic output
 Visual position indicator

DE actuator - All sizes
 SR actuator ≤DN150

Actuator	Sizes	CODE	€
Double Acting	DN10 - DN300	65395	124,99
Spring Return	DN10 - DN150	65395	124,99

C08

**BOX FINECORSA**

per attuatori pneumatici

Brand: Festo
 Connessione plug & play
 Uscita elettronica
 Indicatore visuale di posizione

LIMIT SWITCH BOX

for pneumatic actuators

Brand: Festo
 Plug & play connection
 Electronic output
 Visual position indicator

Actuator	Sizes	CODE	€
Double Acting	DN10 - DN300	70736	153,81
Spring Return	DN10 - DN150	70736	153,81
Spring Return	DN200 - DN300	70737	163,69

ACCESSORI VALVOLE ATTUATI - ACCESSORIES ACTUATED VALVES

C08

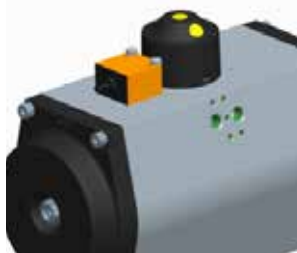

SENSORE DI POSIZIONE INDUTTIVO

per attuatori pneumatici
Brand: IFM
Uscita elettronica.
Visualizzazione in remoto della posizione della valvola (chiusa/aperta)

INDUCTIVE SENSOR

for pneumatic actuators
Brand: IFM
Electronic output
Remote electronic visualization of the valve position (open/close)

Actuator	Sizes	CODE	€
Double Acting	DN10 - DN300	70738	Consultare
Spring Return	DN10 - DN150	70738	Consultare
Spring Return	DN200 - DN300	70739	Consultare

C08



POSIZIONATORE ELETTO-PNEUMATICO

per tutti gli attuatori pneumatici
Brand: Festo
Regolazione della posizione dell'attuatore pneumatico in semplice e doppio effetto nell'installazione di controllo dei processi.

ELECTRO-PNEUMATIC POSITIONER

for pneumatic actuators
Brand: Festo
Regulation of the position for pneumatic actuators Spring return and Double acting in installations of process control.

Actuator	Sizes	CODE	€
Double Acting	DN10 - DN300	PF	Consultare
Spring Return	DN10 - DN150	PF	Consultare
Spring Return	DN200 - DN300	PF	Consultare

C08



BLOCCO DI SICUREZZA (BSR)

per attuatori elettrici

Brand: JJ
Il blocco di sicurezza è un automatismo che, inserito all'attuatore elettrico modello J3, permette di riportare la valvola nella posizione di normale funzionamento, nell'eventualità di un corto circuito sulla linea elettrica o di un black-out.

SAFETY BLOC (BSR)

for electric actuators

Brand: JJ
The Safety Block is an automatism which, when connected to the J3 series electrical actuators, allows the valve to be positioned in a preferential position that is normally closed or normally open (N.C. or N.O.) in the event of a cut in the power supply.

C08



POSIZIONATORE DIGITALE (DPS)

per attuatori elettrici
Brand: JJ
Accessorio per gli attuatori elettrici J+J che converte un segnale elettrico in una differente posizione della valvola attuata elettricamente.

DIGITAL POSITIONING SYSTEM (DPS)

for electric actuators
Brand: JJ
Accessory for J+J electric actuators that converts them into servocontrolled valve positioners.

Accessori PVC-U

Valvole PVC-U

Accessori PVC-C

Valvole PVC-C

Valvole Extreme

Evacuazione

Ricambi

ACCESSORI EVACUAZIONE

EVACUATION FITTINGS

Accessori PVC-U

188 Accessori in PVC grigio ad incollaggio
solvent cement grey PVC accessories



Valvole PVC-U

193 Accessori color arancio con guarnizione elastica
Rubber-ring joint tile colour PVC accessories



Accessori PVC-C

Valvole PVC-C

194 Linea drenaggio
Floor drainage



Valvole Extreme

Evacuazione

Ricambi

ACCESSORI IN PVC GRIGIO AD INCOLLAGGIO - SOLVENT CEMENT GREY PVC ACCESSORIES

C07

**CURVA F-F 87° 30'**

PVC grigio ad incollaggio

ELBOW F-F 87° 30'

Solvent cement grey PVC

SIZE	REF.	PACK	kg	Q(B)	Q(P)	CODE	EUR
32	65 11 032	385x285x178	4,44	120	14.400	02792	0,36
40	65 11 040	385x285x357	8,90	150	9.000	02793	0,37
50	65 11 050	385x285x357	6,30	90	5.400	02794	0,68

C07

**CURVA M-F 87° 30'**

PVC grigio ad incollaggio

ELBOW M-F 87° 30'

Solvent cement grey PVC

SIZE	REF.	PACK	kg	Q(B)	Q(P)	CODE	EUR
32	65 11 032 MH	385x285x178	4,30	120	14.400	28259	0,45
40	65 11 040 MH	385x285x357	8,70	150	9.000	28260	0,45
50	65 11 050 MH	385x285x357	6,20	90	5.400	28261	0,51
75	65 11 075	585x385x357	8,80	60	1.800	02819	1,35
90	65 11 090	585x385x357	10,12	48	1.440	02820	1,76
110	65 11 110	592x495x431	13,77	48	960	02821	1,87
125	65 11 125	592x495x547	15,54	42	672	02822	3,00
160	65 11 160	592x495x547	13,00	20	320	02823	5,92
200	65 11 200	592x495x547	14,18	10	160	02824	12,23
250	65 11 250	592x495x547	12,20	4	64	02825	44,82
315	65 11 315	600x400x510	13,00	2	32	02826	87,76
400	65 11 400	1300x1100x1400	13,13	1	12	02827	366,43

C07

**CURVA F-F 45°**

PVC grigio ad incollaggio

ELBOW F-F 45°

Solvent cement grey PVC

SIZE	REF.	PACK	kg	Q(B)	Q(P)	CODE	EUR
32	65 12 032	385x285x178	4,20	130	15.600	02795	0,45
40	65 12 040	385x285x357	7,30	200	12.000	02796	0,38
50	65 12 050	385x285x357	6,40	90	5.400	02797	0,68

C07

**CURVA M-F 45°**

PVC grigio ad incollaggio

ELBOW M-F 45°

Solvent cement grey PVC

SIZE	REF.	PACK	kg	Q(B)	Q(P)	CODE	EUR
32	65 12 032 MH	385x285x178	4,10	150	18.000	28256	0,59
40	65 12 040 MH	385x285x357	7,79	200	12.000	28257	0,45
50	65 12 050 MH	385x285x357	6,39	90	5.400	28258	0,82
75	65 12 075	385x285x357	5,33	48	2.880	02828	1,23
90	65 12 090	585x385x357	9,00	60	1.800	02829	1,69
110	65 12 110	592x495x431	13,20	60	1.200	02830	1,85
125	65 12 125	592x495x547	13,15	48	768	02831	2,80
160	65 12 160	592x495x547	13,30	27	432	02832	4,61
200	65 12 200	592x495x547	10,18	10	160	02833	9,94
250	65 12 250	600x400x680	9,40	4	64	02834	40,65
315	65 12 315	600x400x680	9,84	2	32	02835	87,18
400	65 12 400	1300x1100x1400	9,74	1	18	02836	223,37

C07

**CURVA F-F 67° 30'**

PVC grigio ad incollaggio

ELBOW F-F 67° 30'

Solvent cement grey PVC

SIZE	REF.	PACK	kg	Q(B)	Q(P)	CODE	EUR
32	65 13 032	385x285x178	6,22	120	14.400	11657	0,60
40	65 13 040	385x285x357	9,39	160	9.600	11658	SULTARE
50	65 13 050	385x285x357	6,22	70	4.200	11659	1,04

ACCESSORI IN PVC GRIGIO AD INCOLLAGGIO - SOLVENT CEMENT GREY PVC ACCESSORIES

C07



CURVA M-F 67° 30'
PVC grigio ad incollaggio

ELBOW M-F 67° 30'
Solvent cement grey PVC

SIZE	REF.	PACK	kg	Q(B)	Q(P)	CODE	EUR
32	65 13 032 MH	385x285x178		120	14.400	28431	1,21
40	65 13 040 MH	385x285x178		80	9.600	28432	1,68
50	65 13 050 MH	385x285x357		70	4.200	28433	1,39
75	65 13 075	385x285x357		36	2.160	04688	1,91
90	65 13 090	585x385x357		48	1.440	04689	2,63
110	65 13 110	592x495x547		48	768	04690	2,28
125	65 13 125	592x495x547		36	576	04691	3,41
160	65 13 160	592x495x547		20	320	04692	6,62
200	65 13 200			10		28384	17,88

C07



DERIVAZIONE SEMPLICE F-F 87° 30'
PVC grigio ad incollaggio

BRANCH F-F 87° 30'
Solvent cement grey PVC

SIZE	REF.	PACK	kg	Q(B)	Q(P)	CODE	EUR
32	65 14 032	385x285x178	4,13	75	9.000	02798	0,67
40	65 14 040	385x285x357	6,40	80	4.800	02799	0,77
50	65 14 050	385x285x357	5,50	50	3.000	02800	1,04

C07



DERIVAZIONE SEMPLICE M-F 87° 30'
PVC grigio ad incollaggio

BRANCH M-F 87° 30'
Solvent cement grey PVC

SIZE	REF.	PACK	kg	Q(B)	Q(P)	CODE	EUR
75	65 14 075	585x385x357	9,60	48	1.440	02837	2,46
90	65 14 090	585x385x357	8,32	32	960	02838	3,53
110	65 14 110	592x495x547	15,00	30	480	02839	3,49
125	65 14 125	592x495x547	13,68	22	352	02840	4,95
160	65 14 160	592x495x547	11,73	12	192	02841	7,62
200	65 14 200	592x495x547	8,75	5	80	02842	20,68
250	65 14 250	592x495x431	8,86	2	40	02843	67,62
315	65 14 315	592x495x431	8,68	1	20	02844	154,17

C07



DERIVAZIONE SEMPLICE F-F 45°
PVC grigio ad incollaggio

BRANCH F-F 45°
Solvent cement grey PVC

SIZE	REF.	PACK	kg	Q(B)	Q(P)	CODE	EUR
32	65 15 032	385x285x178	4,20	60	7.200	02801	0,72
40	65 15 040	385x285x357	7,60	80	4.800	02802	0,87
50	65 15 050	385x285x357	5,52	40	2.400	02803	1,18

C07



DERIVAZIONE SEMPLICE M-F 45°
PVC grigio ad incollaggio

BRANCH M-F 45°
Solvent cement grey PVC

SIZE	REF.	PACK	kg	Q(B)	Q(P)	CODE	EUR
75	65 15 075	585x385x357	9,72	36	1.080	02846	2,88
90	65 15 090	592x495x431	13,32	36	720	02847	3,73
110	65 15 110	592x495x547	14,38	26	416	02848	4,24
125	65 15 125	592x495x547	15,54	20	320	02849	5,68
160	65 15 160	592x495x547	12,00	8	128	02850	11,00
200	65 15 200	592x495x547	8,00	4	64	02851	21,62
250	65 15 250	592x495x547	12,00	2	32	02852	81,82
315	65 15 315	592x495x547	12,20	1	16	02853	150,96

C07



DERIVAZIONE SEMPLICE F-F 67° 30'
PVC grigio ad incollaggio

BRANCH F-F 67° 30'
Solvent cement grey PVC

SIZE	REF.	PACK	kg	Q(B)	Q(P)	CODE	EUR
32	65 16 032	385x285x178	4,59	75	9.000	11759	1,15
40	65 16 040	385x285x357	6,83	80	4.800	11760	1,27
50	65 16 050	385x285x357	6,83	50	3.000	11761	SULTARE

Accessori PVC-U

Valvole PVC-U

Accessori PVC-C

Valvole PVC-C

Valvole Extreme

Evacuazione

Ricambi

ACCESSORI IN PVC GRIGIO AD INCOLLAGGIO - SOLVENT CEMENT GREY PVC ACCESSORIES

C07



DERIVAZIONE SEMPLICE M-F 67° 30'
PVC grigio ad incollaggio

BRANCH M-F 67° 30'
Solvent cement grey PVC

SIZE	REF.	PACK	kg	Q(B)	Q(P)	CODE	EUR
75	65 16 075	585x385x357	11,80	36	1.080	04693	3,71
90	65 16 090	585x385x357	-	24	720	04694-IT	4,82
110	65 16 110	592x495x431	13,16	22	440	04695	5,57
125	65 16 125	592x495x547	14,04	18	288	04696	6,15
160	65 16 160	592x495x547	10,30	8	128	04697	16,55

C07



DERIVAZIONE M-F 87° 30' DOPPIA
PVC grigio ad incollaggio

DOUBLE BRANCH M-F 87° 30'
Solvent cement grey PVC

SIZE	REF.	PACK	kg	Q(B)	Q(P)	CODE	EUR
110	65 17 110	592x495x547	6,83	20	200	11668 SULTARE	
125	65 17 125	592x495x547	6,83	14	840	11669 SULTARE	

C07



DERIVAZIONE M-F 45° DOPPIA PAR
PVC grigio ad incollaggio

DOUBLE BRANCH M-F 45°
Solvent cement grey PVC

SIZE	REF.	PACK	kg	Q(B)	Q(P)	CODE	EUR
110	65 18 110	592x495x547	6,83	4	40	11672 SULTARE	
125	65 18 125	592x495x547	6,83	10	600	11673 SULTARE	

C07



SELLA
PVC grigio ad incollaggio

SOLVENT WELDED SADDLE
Solvent cement grey PVC

SIZE	REF.	PACK	kg	Q(B)	Q(P)	CODE	EUR
110 / 125 x 50	65 25 110	385x285x357	5,10	50	3.000	11696	1,68
110 / 125 x 40	65 25 111	385x285x357	5,25	50	3.000	11697	1,68
110 / 125 x 32	65 25 112	385x285x357	5,40	50	3.000	11698	1,68

C07



MANICOTTO F-F
PVC grigio ad incollaggio

COUPLING F-F
Solvent cement grey PVC

SIZE	REF.	PACK	kg	Q(B)	Q(P)	CODE	EUR
32	65 07 032	385x285x178	5,00	250	30.000	02804	0,45
40	65 07 040	385x285x178	4,62	140	16.800	02805	0,55
50	65 07 050	385x285x357	5,70	15	900	02806	0,67
75	65 07 075	385x285x357	6,54	60	3.600	02905	1,46
90	65 07 090	585x385x357	9,24	66	1.980	02906	1,59
110	65 07 110	592x495x431	12,84	60	1.200	02907	2,03
125	65 07 125	592x495x431	12,48	48	960	02908	2,63
160	65 07 160	592x495x547	11,18	27	432	02909	4,60
200	65 07 200	592x495x431	8,50	12	240	02910	10,36
250	65 07 250	-	7,80	4	56	02911	49,57
315	65 07 315	-	102,00	30	30	02912	95,16

C07



BUSSOLA RIDUZIONE
PVC grigio ad incollaggio

REDUCER
Solvent cement grey PVC

SIZE	REF.	PACK	kg	Q(B)	Q(P)	CODE	EUR
40 / 32	65 21 032	385x285x178	5,71	350	42.000	02816	0,36
50 / 40	65 21 040	385x285x178	5,71	175	21.000	02817	0,45

ACCESSORI IN PVC GRIGIO AD INCOLLAGGIO - SOLVENT CEMENT GREY PVC ACCESSORIES

C07



TAPPO DI REGISTRO FILETTATO
PVC grigio ad incollaggio

ACCESS PLUG
Solvent cement grey PVC

SIZE	REF.	PACK	kg	Q(B)	Q(P)	CODE	EUR
32	65 30 032	385x285x178	5,40	250	36.000	15890	1,19
40	65 30 040	385x285x178	7,80	150	36.000	15891	1,31
50	65 30 050	385x285x178	6,30	180	21.600	15892	1,64
75	65 30 075	385x285x178	5,40	54	6.480	15894	3,18
90	65 30 090	385x285x178	5,12	42	5.040	15895	5,29
110	65 30 110	385x285x178	4,56	70	3.600	15896	4,44
125	65 30 125	385x285x357	6,13	50	2.100	15897	10,35
160	65 30 160	1300x1100x1400		30	420	15899	11,20
200	65 30 200	1300x1100x1400		40	300	15900	16,63
250	65 30 250		12,89	10	100	15901	61,21
315	65 30 315		11,86	6	60	15902	110,10

C07



RIDUZIONE ECCENTRICA F-M
PVC grigio ad incollaggio

INVERT REDUCER F-M
Solvent cement grey PVC

SIZE	REF.	PACK	kg	Q(B)	Q(P)	CODE	EUR
32 x 40	65 20 032	385x285x178	4,80	160	19.200	02813	0,60
40 x 50	65 20 040	385x285x357	5,00	150	9.000	02814	0,67
50 x 75	65 31 050	385x285x178	4,10	50	6.000	02891	1,52
75 x 90	65 31 075	385x285x357	8,25	66	3.960	02892	1,81
75 x 110	65 31 076	585x385x357	11,25	75	2.250	02893	1,91
90 x 110	65 31 090	585x385x357	12,38	75	2.250	02894	1,88
90 x 125	65 31 091	585x385x357	12,60	64	1.920	02895	2,81
110 x 125	65 31 110	585x385x357	11,00	56	1.680	02897	1,90
110 x 160	65 31 111	592x495x431	11,10	40	800	02898	2,92
125 x 160	65 31 125	592x495x431	12,60	45	900	02899	2,90
125 x 200	65 31 126	592x495x547		30	480	02900	15,09
160 x 200	65 31 160	592x495x547	14,25	30	480	02901	11,40
160 x 250	65 31 161		8,50	6	48	15904	39,38
200 x 250	65 31 200	592x495x547	15,20	16	256	02902	22,35
200 x 315	65 31 201		11,30	32	32	15906	75,35
250 x 315	65 31 250		15,00	50	50	02903	91,03
315 x 400	65 31 315		05,00	18	18	02904	172,52

C07



TAPPO
PVC grigio ad incollaggio

SOCKET PLUG
Solvent cement grey PVC

SIZE	REF.	PACK	kg	Q(B)	Q(P)	CODE	EUR
32	65 08 032	385x285x178	4,80	300	36.000	35544	0,70
40	65 08 040	385x285x178	4,50	300	36.000	02808	0,60
50	65 08 050	385x285x178	6,00	200	24.000	02809	0,77
75	65 08 075	385x285x178	5,04	70	8.400	02924	0,95
90	65 08 090	385x285x178	4,20	56	6.720	02925	1,06
110	65 08 110	385x285x357	6,58	70	4.200	02926	0,96
125	65 08 125	385x285x357	7,50	60	3.600	02927	1,63
160	65 08 160	385x285x357	5,10	20	1.200	02928	4,20
200	65 08 200	385x285x357	4,73	11	660	02929	5,87
250	65 08 250		14,27	13	104	02930	33,61
315	65 08 315		12,09	6	48	02931	64,96
400	65 08 400		17,85	3	50	02932	125,09

Accessori PVC-U

Valvole PVC-U

Accessori PVC-C

Valvole PVC-C

Valvole Extreme

Evacuazione

Ricambi

ACCESSORI IN PVC GRIGIO AD INCOLLAGGIO - SOLVENT CEMENT GREY PVC ACCESSORIES

C07

**TAPPO DI RIDUZIONE SEMPLICE**

PVC grigio ad incollaggio

REDUCER PLUG

Solvent cement grey PVC

SIZE	REF.	PACK	kg	Q(B)	Q(P)	CODE	EUR
75 - 50	65 28 575	385x285x178	5,25	70	8.400	02933	1,31
75 - 40	65 28 576	385x285x178	5,20	70	8.400	11706	1,31
75 - 32	65 28 577	385x285x178	5,14	70	8.400	11705	1,31
90 - 50	65 28 493	385x285x178	4,40	56	6.720	11708	1,41
90 - 40	65 28 494	385x285x178	4,38	56	6.720	11709	1,41
90 - 32	65 28 495	385x285x178	4,30	56	6.720	11710	1,41
110 x 90	65 28 518	385x285x357	6,40	70	4.200	35546 SULTARE	
110 x 75	65 28 519	385x285x357	6,80	70	4.200	35547 SULTARE	
110 x 50	65 28 515	385x285x357	7,20	70	4.200	11715	1,62
110 x 40	65 28 516	385x285x357	7,10	35	4.200	11716	3,51
110 x 32	65 28 517	385x285x357	7,00	70	4.200	11717	1,62
125 x 40	65 28 528	385x285x357	7,95	60	3.600	11720	2,07
125 x 50	65 28 527	385x285x357	8,00	60	3.600	11719	2,22
125 x 75	65 28 524	385x285x357	7,50	60	3.600	35551	3,01
125 x 90	65 28 523	385x285x357	7,40	60	3.600	35550	3,01
125 x 110	65 28 522	385x285x357	6,00	42	2.520	35549	3,02
160 x 110	65 28 561	385x285x357	4,00	20	1.200	35552 SULTARE	
160 x 125	65 28 560	385x285x357	4,10	20	1.200	35553	4,76
200 x 125	65 28 591	385x285x357	4,40	11	660	35554 SULTARE	
200 x 160	65 28 590	385x285x357	4,00	11	660	35555	10,94

C07

**TAPPO DI RIDUZIONE DOPPIA**

PVC grigio ad incollaggio

DOUBLE REDUCER PLUG

Solvent cement grey PVC

SIZE	REF.	PACK	kg	Q(B)	Q(P)	CODE	EUR
90 x 32 - 32	65 28 491	385x285x178	4,50	56	6.720	11707	1,52
110 x 32 - 32	65 28 514	385x285x357	7,10	70	4.200	11714 SULTARE	
110 x 40 - 32	65 28 513	385x285x357	7,10	70	4.200	11713	2,06
110 x 40 - 40	65 28 512	385x285x357	7,20	70	4.200	11712	2,06
110 x 50 - 40	65 28 510	385x285x357	8,20	70	4.200	02936	2,06
110 x 50 - 32	65 28 511	385x285x357	7,25	70	4.200	11711 SULTARE	
125 x 40 - 32	65 28 526	385x285x357	8,20	60	3.600	11718 SULTARE	
125 x 40 - 40	65 28 520	385x285x357	8,30	60	3.600	35548 SULTARE	
125 x 50 - 40	65 28 525	385x285x357	8,35	60	3.600	02937-IT	2,47

C07

**TAPPO DI RIDUZIONE TRIPLA**

PVC grigio ad incollaggio

TRIPLE REDUCER PLUG

Solvent cement grey PVC

SIZE	REF.	PACK	kg	Q(B)	Q(P)	CODE	EUR
110x40-40-40	65 28 410	385x285x178	8,00	35	4.200	02935 SULTARE	1,92

C07

ACCESSORI COLOR ARANCIO CON GUARNIZIONE ELASTICA - RUBBER-RING JOINT TILE COLOUR PVC

C07



MANICOTTO DI DILATAZIONE F-F
PVC color arancio con guarnizione elastica

COUPLING F-F
Rubber-ring joint tile colour PVC

SIZE	REF.	PACK	kg	Q(B)	Q(P)	CODE	EUR
110	64 07 110	600x400x450	10,50	45	312	35511	3,75
125	64 07 125	600x400x480	10,80	36	240	35512	6,60
160	64 07 160	800x600x450	11,00	18	72	35513	12,08
200	64 07 200	600x400x450	8,55	8	72	35514	22,67
250	64 07 250	800x1200x950	82,00	36	36	35515	50,34
315	64 07 315	800x1200x950	64,00	16	20	35516	96,18
400	64 07 400	1300x1100x1400	72,50	10	10	35517	173,27

C07



CURVA M-F 87°30'
PVC color arancio con guarnizione elastica

ELBOW M-F 87° 30'
Rubber-ring joint tile colour PVC

SIZE	REF.	PACK	kg	Q(B)	Q(P)	CODE	EUR
110	64 11 110	600x400x480	23,58	25	200	35478	4,91
125	64 11 125	600x400x480	16,24	20	160	35479	6,56
160	64 11 160	600x400x480	18,38	20	80	35480	13,38
200	64 11 200	800x600x450	16,18	1	40	35481	26,09
250	64 11 250	800x1200x950	68,12	1	20	35482	63,40
315	64 11 315	800x1200x950	64,24	1	10	35483	132,20
400	64 11 400	800x1200x950	13,70	1	6	35484	279,01

C07



CURVA M-H 45°
PVC color arancio con guarnizione elastica

ELBOW M-F 45°
Rubber-ring joint tile colour PVC

SIZE	REF.	PACK	kg	Q(B)	Q(P)	CODE	EUR
110	64 12 110	600x400x480	22,34	35	280	35492	3,93
125	64 12 125	600x400x480	15,84	23	184	35493	5,39
160	64 12 160	600x400x480	15,36	10	80	35494	10,63
200	64 12 200	600x400x480	14,78	5	40	35495	20,69
250	64 12 250	800x1200x900	59,16	1	23	35496	57,74
315	64 12 315	800x1200x950	63,02	12	14	35497	95,54
400	64 12 400	800x1200x950	10,94	1	7	35498	258,46

C07



DERIVAZIONE SEMPLICE M-F 87° 30'
PVC color arancio con guarnizione elastica

BRANCH M-F 87° 30'
Rubber-ring joint tile colour PVC

SIZE	REF.	PACK	kg	Q(B)	Q(P)	CODE	EUR
110	64 14 110	800x600x450	17,89	20	144	35499	9,74
125	64 14 125	800x600x450	14,10	22	88	35500	10,49
160	64 14 160	800x600x450	14,90	12	48	35501	22,67
200	64 14 200	800x1200x950	61,91	1	30	35502	35,63
250	64 14 250	800x1200x900	59,75	12	12	35503	96,93
315	64 14 315	800x1200x950	-	1	8	35504	227,55

C07



DERIVAZIONE SEMPLICE M-F 45°
PVC color arancio con guarnizione elastica

BRANCH M-F 45°
Rubber-ring joint tile colour PVC

SIZE	REF.	PACK	kg	Q(B)	Q(P)	CODE	EUR
110	64 15 110	600x400x480	22,21	15	120	35505	10,26
125	64 15 125	800x600x450	15,66	19	76	35506	12,59
160	64 15 160	800x600x450	12,61	8	32	35507	22,58
200	64 15 200	800x1200x900	59,33	1	22	35508	51,28
250	64 15 250	800x1200x900	53,17	8	8	35509	122,69
315	64 15 315	600x500x350	12,47	1	8	35510	322,89

C07



RIDUZIONE ECCENTRICA
PVC color arancio con guarnizione elastica

INVERT REDUCER F-M
Rubber-ring joint tile colour PVC

SIZE	REF.	PACK	kg	Q(B)	Q(P)	CODE	EUR
110 x 125	64 31 110	1300x1100x1400	86,40	36	288	35522	4,91
110 x 160	64 31 111	590x390x480	15,28	30	480	35523	7,96
125 x 160	64 31 125	600x400x480	15,00	27	240	35524	8,53
125 x 200	64 31 126	500x450x600	13,46	15	120	35525	21,36
160 x 200	64 31 160	600x400x450	15,20	16	128	35527	16,53
200 x 250	64 31 200	1300x1100x1400	110,25	63	63	35530	38,55
250 x 315	64 31 250	800x1200x950	94,50	30	32	35532	73,10
315 x 400	64 31 315	800x1200x950	5,00	18	18	35533	166,49

Accessori PVC-U

Valvole PVC-U

Accessori PVC-C

Valvole PVC-C

Valvole Extreme

Evacuazione

Ricambi

LINEA DRENAGGIO - FLOOR DRAINAGE

C07

**POZZETTO SEMPLICE GRIGIO**

Linea drenaggio

CATCH PIT grey

Floor drainage

SIZE	REF.	PACK	kg	Q(B)	Q(P)	CODE	EUR
20 x 20 x 20	65 90 020	20X20X20	0,75	1	216	15926	9,07
30 x 30 x 30	65 90 030	30X30X30	1,80	1	72	15927	17,43
40 x 40 x 40	65 90 040	40X40X40	3,19	1	30	15928	29,18
55 x 55 x 55	65 90 055	55X55X55	5,64	1	16	15930	66,12

C07

**TELAIO SEMPLICE GRIGIO**

Linea drenaggio

FRAME grey

Floor drainage

SIZE	REF.	PACK	kg	Q(B)	Q(P)	CODE	EUR
20 x 20	65 90 120	43X32X24	4,95	16	256	15931	5,20
30 x 30	65 90 130	60X60X22	14,58	15	240	15932	7,90
40 x 40	65 90 140	40X40X0,4	0,77	1	180	15933	11,05
55 x 55	65 90 155	50X50X0,5	1,95	1	100	15935	21,82

C07

**COPERCHIO SEMPLICE GRIGIO**

Linea drenaggio

WALKWAY COVER grey

Floor drainage

SIZE	REF.	PACK	kg	Q(B)	Q(P)	CODE	EUR
20 x 20	65 90 220	57X38X35	11,20	20	480	15936	5,57
30 x 30	65 90 230	57X38X35	13,34	20	320	15937	11,80
40 x 40	65 90 240	40X40X0,4	2,25	1	180	15938	23,60
55 x 55	65 90 255	50X50X0,5	2,02	1	48	15940	58,44

C07

**GRIGLIA SEMPLICE GRIGIA**

Linea drenaggio

WALKWAY GRILL grey

Floor drainage

SIZE	REF.	PACK	kg	Q(B)	Q(P)	CODE	EUR
20 x 20	65 90 320	57X38X35	7,00	20	480	15941	5,57
30 x 30	65 90 330	57X38X35	10,20	18	288	15942	11,80
40 x 40	65 90 340	40X40X0,4	1,85	1	108	15943	23,97

C07

**POZZETTO SEMPLICE NERO**

Linea drenaggio

Floor drainage

SIZE	REF.	PACK	kg	Q(B)	Q(P)	CODE	EUR
20 x 20 x 20	65 91 020	20X20X20	0,86	1	216	35558	8,28
30 x 30 x 30	65 91 030	30X30X30	1,81	1	72	35559	15,92
40 x 40 x 40	65 91 040	40X40X40	0,38	1	30	35560	26,60
55 x 55 x 55	65 91 055	55X55X55	6,23	1	16	35561	62,19

C07

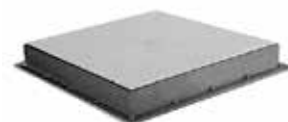
**TELAIO SEMPLICE NERO**

Linea drenaggio

Floor drainage

SIZE	REF.	PACK	kg	Q(B)	Q(P)	CODE	EUR
20 x 20	65 90 120	57X38X35	4,50	16	320	35562	4,77
30 x 30	65 90 130	57X37X33	6,60	22	264	35563	7,31
40 x 40	65 91 140	40X40X0,5	0,80	1	180	35564	10,35
55 x 55	65 91 155	55X55X0,6	1,95	1	100	35565	20,15

C07

**COPERCHIO SEMPLICE NERO**

Linea drenaggio

Floor drainage

SIZE	REF.	PACK	kg	Q(B)	Q(P)	CODE	EUR
20 x 20	65 91 220	57X38X35	11,10	10	480	35566	5,20
30 x 30	65 91 230	57X38X35	15,20	18	288	35567	10,82
40 x 40	65 91 240	40X40X0,4	2,02	1	108	35568	21,58
55 x 55	65 91 255	55X55X0,6	4,89	1	60	35569	53,81

LINEA DRENAGGIO - FLOOR DRAINAGE

C07



GRIGLIA SEMPLICE NERA

Linea drenaggio

Floor drainage

SIZE	REF.	PACK	kg	Q(B)	Q(P)	CODE	EUR
20 x 20	65 91 320	57X38X35	7,10	20	360	35570	5,10
30 x 30	65 91 330	57X38X35	10,50	20	320	35571	10,78
40 x 40	65 97 340	40X40X0,4	2,42	1	108	35572	21,74
55 x 55	65 97 355	55X55X0,7	5,10	1	48	35573	54,32

C07



CANALETTA 0,5 m. IN PP GRIGIO

Linea drenaggio

CHANNEL LONG. 0,5 m. in grey PP

Floor drainage

SIZE	REF.	PACK	kg	Q(B)	Q(P)	CODE	EUR
13 x 50	65 97 213	50X30X54	8,50	20	640	15964	7,09
20 x 50	65 97 220	60X40X53	9,40	10	200	15965	13,53

C07



GRIGLIA PER CANALETTA

Linea drenaggio

GRID

Floor drainage

SIZE	REF.	PACK	kg	Q(B)	Q(P)	CODE	EUR
13 x 50	65 97 313	50X13X0,2	0,60	1	800	15968	10,09
20 x 50	65 97 320	50X20X0,2	1,37	1	500	15969	13,30

C07



CHIUSURA LATERALE CON SCARICO

Linea drenaggio

OUTLET SOCKET

Floor drainage

SIZE	REF.	PACK	kg	Q(B)	Q(P)	CODE	EUR
13	-	30X26X27	3,70	65	2.405	15970	3,05
20	-	30X26X27	2,50	12	1.152	15971	3,55

Accessori PVC-U

Valvole PVC-U

Accessori PVC-C

Valvole PVC-C

Valvole Extreme

Evacuazione

Ricambi

Accessori PVC-U

Valvole PVC-U

Accessori PVC-C

Valvole PVC-C

Valvole Extreme

Evacuazione

Ricambi

RICAMBI

SPARE PARTS

BOCCHETTONI E PORTAGOMMA - UNIONS

C01 007 900

Accessori PVC-U

Valvole PVC-U

Accessori PVC-C

Valvole PVC-C

Valvole Extreme

Evacuazione

Ricambi

O-RING BOCCHETTONE - UNION O-RING					
CODE	DESCRIZIONE	DESCRIPTION	Fig.	Q	EUR
723 R 0155026	O-Ring D16 - 3/4"	O-Ring D16 - 3/4"	1	10	0,45
723 R 0202035	O-Ring D20 - 1/2"	O-Ring D20 - 1/2"	1	10	0,76
723 R 0282035	O-Ring D25 - 3/4"	O-Ring D25 - 3/4"	1	10	0,94
723 R 0329035	O-Ring D32 - 1"	O-Ring D32 - 1"	1	10	1,14
723 R 0407053	O-Ring D40 - 1 1/4"	O-Ring D40 - 1 1/4"	1	10	1,35
723 R 0470053	O-Ring D50 - 1 1/2"	O-Ring D50 - 1 1/2"	1	10	1,82
723 R 0597053	O-Ring D63 - 2"	O-Ring D63 - 2"	1	5	2,05
723 R 0756053	O-Ring D75 - 2 1/2"	O-Ring D75 - 2 1/2"	1	5	4,90
723 R 0914053	O-Ring D90 - 3"	O-Ring D90 - 3"	1	2	6,40
723 R 1168070	O-Ring D110 - 4"	O-Ring D110 - 4"	1	1	6,68

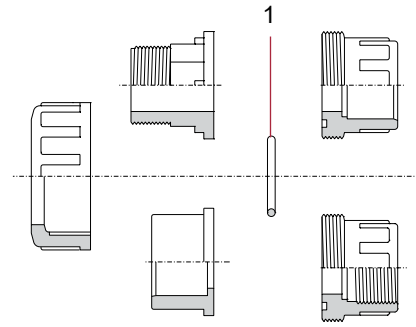

GUARNIZIONE PORTAGOMMA CON GHIERA - SPIGOT AND NUT UNION O-RING					
CODE	DESCRIZIONE	DESCRIPTION	Fig.	Q	EUR
02401 R 0134	Guarnizione D16 - 3/4"	Flat gasket D16 - 3/4"	1	10	0,59
02401 R 0134	Guarnizione D18 - 1/2"	Flat gasket D18 - 1/2"	1	10	0,59
02401 R 0134	Guarnizione D20 - 1/2"	Flat gasket D20 - 1/2"	1	10	0,59
02402 R 0134	Guarnizione D25 - 3/4"	Flat gasket D25 - 3/4"	1	10	0,77
02403 R 0134	Guarnizione D32 - 1"	Flat gasket D32 - 1"	1	10	0,75
02404 R 0134	Guarnizione D40 - 1 1/4"	Flat gasket D40 - 1 1/4"	1	10	1,01
02405 R 0134	Guarnizione D50 - 1 1/2"	Flat gasket D50 - 1 1/2"	1	5	1,39
02405 R 0134	Guarnizione D50 - 1 1/2" (D38)	Flat gasket D50 - 1 1/2" (D38)	1	5	1,39
02407 R 0134	Guarnizione D63 - 2"	Flat gasket D63 - 2"	1	5	1,70

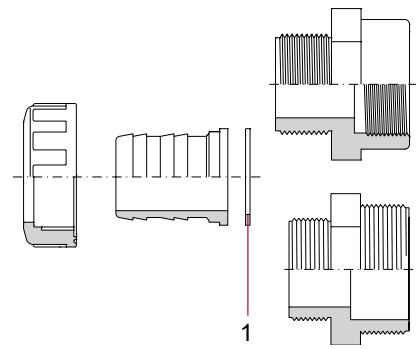

VISORI PER LIQUIDI - SIGHT GLASSES

C01 007 900

VISORE - SIGHT					
CODE	DESCRIZIONE	DESCRIPTION	Fig.	Q	EUR
02387 R 0100	Visore D50	Sight D50	1	1	21,59
02388 R 0100	Visore D63	Sight D63	1	1	23,98
02389 R 0100	Visore D75	Sight D75	1	1	29,92
02390 R 0100	Visore D90	Sight D90	1	1	36,68
02391 R 0100	Visore D110	Sight D110	1	1	52,11
02392 R 0100	Visore D125	Sight D125	1	1	65,91
02393 R 0100	Visore D140	Sight D140	1	1	90,47
02394 R 0100	Visore D160	Sight D160	1	1	101,81
02395 R 0100	Visore D200	Sight D200	1	1	138,99
02396 R 0100	Visore D225	Sight D225	1	1	168,53

O-RING VISORE EPDM - SIGHT O-RING EPDM					
CODE	DESCRIZIONE	DESCRIPTION	Fig.	Q	EUR
02575 R 0135	O-Ring visore EPDM D50	Sight O-Ring EPDM D50	2	8	2,06
02576 R 0135	O-Ring visore EPDM D63	Sight O-Ring EPDM D63	2	8	2,86
723 R 0798053	O-Ring visore EPDM D75	Sight O-Ring EPDM D75	2	5	2,18
723 R 1000053	O-Ring visore EPDM D90	Sight O-Ring EPDM D90	2	2	1,94
723 R 1207053	O-Ring visore EPDM D110	Sight O-Ring EPDM D110	2	2	3,12
723 R 1397053	O-Ring visore EPDM D125	Sight O-Ring EPDM D125	2	2	4,10
723 R 1550053	O-Ring visore EPDM D140	Sight O-Ring EPDM D140	2	2	4,39
723 R 1708053	O-Ring visore EPDM D160	Sight O-Ring EPDM D160	2	2	5,54
723 R 2153053	O-Ring visore EPDM D200	Sight O-Ring EPDM D200	2	2	9,23
723 R 2380060	O-Ring visore EPDM D225	Sight O-Ring EPDM D225	2	2	11,05

COLLARE VISORE - SIGHT END CONNECTOR					
CODE	DESCRIZIONE	DESCRIPTION	Fig.	Q	EUR
02387 R 0105	Collare / flangia D50	End connector D50	3	2	6,00
02388 R 0105	Collare / flangia D63	End connector D63	3	2	7,14
02389 R 0105	Collare / flangia D75	End connector D75	3	2	50,24
02390 R 0105	Collare / flangia D90	End connector D90	3	2	65,87
02391 R 0105	Collare / flangia D110	End connector D110	3	2	87,71
02392 R 0105	Collare / flangia D125	End connector D125	3	2	97,51
02393 R 0105	Collare / flangia D140	End connector D140	3	2	119,66
02394 R 0105	Collare / flangia D160	End connector D160	3	2	183,18
02395 R 0105	Collare / flangia D200	End connector D200	3	2	197,40
02396 R 0105	Collare / flangia D225	End connector D225	3	2	363,57
02397 R 0105	Collare / flangia 1 1/2"	End connector 1 1/2"	3	2	11,59
02398 R 0105	Collare / flangia 2"	End connector 2"	3	2	13,32

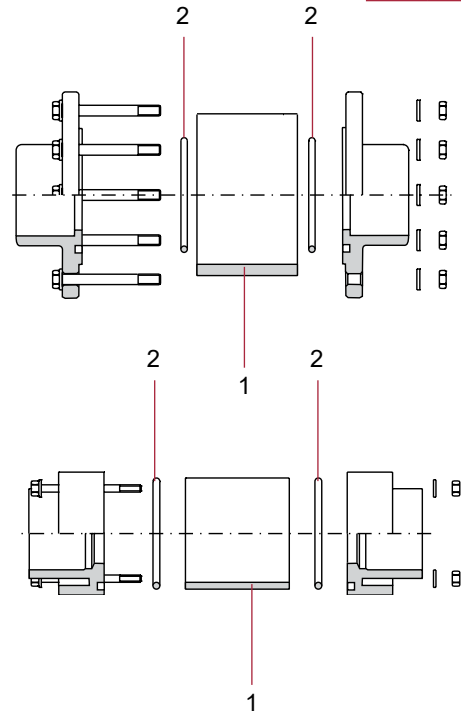

VALVOLE A SFERA IN PVC-U SERIE [STD] - PVC-U BALL VALVES [STD] SERIES

C01 | 007 900

D16 - 3/8" / D20 - 1/2"					
CODE	DESCRIZIONE	DESCRIPTION	Fig.	Q	EUR
36501 R 0124	Kit maniglia standard	Standard handle assembly	4	5	5,18
36501 R 0104	Ghiera	Union nut	3	10	2,95
36500 R 0105	Manicotto D16	16 mm connection	5	10	1,54
36501 R 0105	Manicotto D20	20 mm connection	5	10	1,54
36510 R 0105	Manicotto 3/8" BSP	3/8" connection BSP	5	10	2,69
36511 R 0105	Manicotto 1/2" BSP	1/2" connection BSP	5	10	2,69
723 R 0202035	O-Ring manicotto EPDM	Union O-Ring EPDM	10	10	0,76
36501 R 0102	Sfera	Ball	7	5	3,59
36501 R 0135	Kit guarniz. EPDM/PE	O-Ring kit EPDM/PE	1+7	1	8,85
36501 R 0121	Perno + O-Ring EPDM	Shaft + EPDM O-Rings	1+7	5	2,43

D25 - 3/4"					
CODE	DESCRIZIONE	DESCRIPTION	Fig.	Q	EUR
36502 R 0124	Kit maniglia standard	Standard handle assembly	4	5	5,56
36502 R 0104	Ghiera	Union nut	3	10	3,12
36502 R 0105	Manicotto D25	25 mm connection	5	10	1,79
36512 R 0105	Manicotto 3/4" BSP	3/4" connection BSP	5	10	2,96
723 R 0282035	O-Ring manicotto EPDM	Union O-Ring EPDM	10	10	0,94
36502 R 0102	Sfera	Ball	7	5	3,95
36502 R 0135	Kit guarniz. EPDM/PE	O-Ring kit EPDM/PE	1+7	1	9,07
36502 R 0121	Perno + O-Ring EPDM	Shaft + EPDM O-Rings	1+7	5	2,55

D32 - 1"					
CODE	DESCRIZIONE	DESCRIPTION	Fig.	Q	EUR
36503 R 0124	Kit maniglia standard	Standard handle assembly	4	5	7,57
36503 R 0104	Ghiera	Union nut	3	10	4,02
36503 R 0105	Manicotto D32	32 mm connection	5	10	2,25
36513 R 0105	Manicotto 1" BSP	1" connection BSP	5	10	3,98
723 R 0329035	O-Ring manicotto EPDM	Union O-Ring EPDM	10	10	1,14
36503 R 0102	Sfera	Ball	6+7+8+9+10	5	4,75
36503 R 0135	Kit guarniz. EPDM/PE	O-Ring kit EPDM/PE	1+7	1	11,77
36503 R 0121	Perno + O-Ring EPDM	Shaft + EPDM O-Rings	1-7	5	3,03

D40 - 1 1/4"					
CODE	DESCRIZIONE	DESCRIPTION	Fig.	Q	EUR
36504 R 0124	Kit maniglia standard	Standard handle assembly	4	5	10,47
36504 R 0104	Ghiera	Union nut	3	10	4,38
36504 R 0105	Manicotto D40	40 mm connection	5	10	2,76
36514 R 0105	Manicotto 1 1/4" BSP	1 1/4" connection BSP	5	10	4,66
723 R 0407053	O-Ring manicotto EPDM	Union O-Ring EPDM	10	10	1,35
36504 R 0102	Sfera	Ball	6+7+8+9+10	5	5,96
36504 R 0135	Kit guarniz. EPDM/PE	O-Ring kit EPDM/PE	1+7	1	13,06
36504 R 0121	Perno + O-Ring EPDM	Shaft + EPDM O-Rings	1-7	5	3,55

D50 - 1 1/2"					
CODE	DESCRIZIONE	DESCRIPTION	Fig.	Q	EUR
36505 R 0124	Kit maniglia standard	Standard handle assembly	4	4	13,30
36505 R 0104	Ghiera	Union nut	3	8	6,24
36505 R 0105	Manicotto D50	50 mm connection	5	8	4,16
36515 R 0105	Manicotto 1 1/2" BSP	1 1/2" connection BSP	5	8	6,57
723 R 0470053	O-Ring manicotto EPDM	Union O-Ring EPDM	6+7+8+9+10	8	1,82
36505 R 0102	Sfera	Ball	1+7	4	7,89
36505 R 0135	Kit guarniz. EPDM/PE	O-Ring kit EPDM/PE	6-7-8-9-10	1	13,55
36505 R 0121	Perno + O-Ring EPDM	Shaft + EPDM O-Rings	1-7	4	4,37

D63 - 2"					
CODE	DESCRIZIONE	DESCRIPTION	Fig.	Q	EUR
36506 R 0124	Kit maniglia standard	Standard handle assembly	4	4	17,61
36506 R 0104	Ghiera	Union nut	3	8	9,77
36506 R 0105	Manicotto D63	63 mm connection	5	8	7,00
36516 R 0105	Manicotto 2" BSP	2" connection BSP	5	8	9,32
723 R 0597053	O-Ring manicotto EPDM	Union O-Ring EPDM	6+7+8+9+10	8	2,05
36506 R 0102	Sfera	Ball	1+7	4	12,14
36506 R 0135	Kit guarniz. EPDM/PE	O-Ring kit EPDM/PE	6-7-8-9-10	1	14,26
36506 R 0121	Perno + O-Ring EPDM	Shaft + EPDM O-Rings	1-7	4	4,93

D75 - 2 1/2"					
CODE	DESCRIZIONE	DESCRIPTION	Fig.	Q	EUR
36507 R 0124	Kit maniglia standard	Standard handle assembly	4	2	23,65
36507 R 0104	Ghiera	Union nut	3	4	30,90
36507 R 0105	Manicotto D75	75 mm connection	5	4	18,94
36517 R 0105	Manicotto 2 1/2" BSP	2 1/2" connection BSP	5	4	27,19
723 R 0756053	O-Ring manicotto EPDM	Union O-Ring EPDM	6+7+8+9+10	4	4,90
36507 R 0102	Sfera	Ball	1+7	2	41,22
36507 R 0135	Kit guarniz. EPDM/PE	O-Ring kit EPDM/PE	6-7-8-9-10	1	29,01
36507 R 0121	Perno + O-Ring EPDM	Shaft + EPDM O-Rings	1-7	2	18,23

D90 - 3"					
CODE	DESCRIZIONE	DESCRIPTION	Fig.	Q	EUR
36508 R 0124	Kit maniglia standard	Standard handle assembly	4	2	29,00
36508 R 0104	Ghiera	Union nut	3	4	47,04
36508 R 0105	Manicotto D90	90 mm connection	5	4	31,52
36518 R 0105	Manicotto 3" BSP	3" connection BSP	5	4	50,96
723 R 0914053	O-Ring manicotto EPDM	Union O-Ring EPDM	6+7+8+9+10	4	6,40
36508 R 0102	Sfera	Ball	1+7	2	69,08
36508 R 0135	Kit guarniz. EPDM/PE	O-Ring kit EPDM/PE	6-7-8-9-10	1	35,47
36508 R 0121	Perno + O-Ring EPDM	Shaft + EPDM O-Rings	1-7	2	20,19

D110 - 4"					
CODE	DESCRIZIONE	DESCRIPTION	Fig.	Q	EUR
36509 R 0124	Kit maniglia	Handle assembly	4	1	32,80
36509 R 0104	Ghiera	Union nut	3	2	111,81
36509 R 0105	Manicotto D110	110 mm connection	5	2	55,24
36519 R 0105	Manicotto 4" BSP	4" connection BSP	6+7+8+9+10	2	75,37
723 R 1092057	O-Ring manicotto EPDM	Union O-Ring EPDM	1+7	2	8,85
22797 R 0102	Sfera	Ball	2	1	83,30
36509 R 0135	Kit guarniz. EPDM/PE	O-Ring kit EPDM/PE	6-7-8-9-10	1	41,16
22797 R 0121	Perno + O-Ring EPDM	Shaft + EPDM O-Rings	1-7	1	30,48
22799 R 0108	Chiave di regolazione	Adjusting tool	11	1	36,34

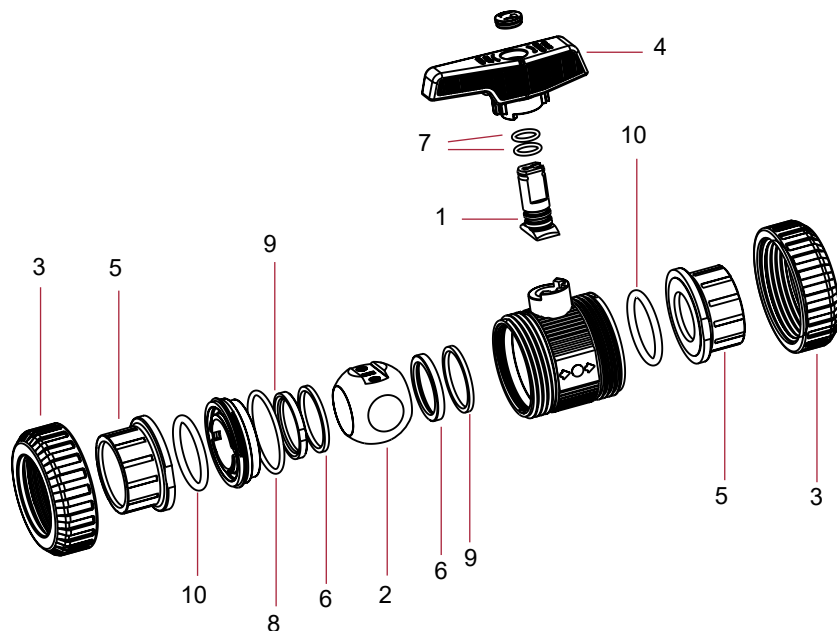

Accessori PVC-U

Valvole PVC-U

Accessori PVC-C

Valvole PVC-C

Valvole Extreme

Evacuazione

Ricambi

VALVOLE A SFERA SERIE [IND] - BALL VALVES [IND] SERIES

C01 | 007 900

D16 - 3/8" / D20 - 1/2"						
CODE	DESCRIZIONE	DESCRIPTION	Fig.	Q	EUR	
36501 R 0124	Kit maniglia	Handle assembly	4	5	5,18	
36501 R 0104	Ghiera	Union nut	3	10	2,95	
36500 R 0105	Manicotto D16	16 mm connection	5	10	1,54	
36501 R 0105	Manicotto D20	20 mm connection	5	10	1,54	
36510 R 0105	Manicotto 3/8" BSP	3/8" connection BSP	5	10	2,69	
36511 R 0105	Manicotto 1/2" BSP	1/2" connection BSP	5	10	2,69	
740 R 0202035	O-Ring manicoetto EPDM Perox.	Union O-Ring Perox. EPDM	10	10	1,80	
714 R 0202035	O-Ring manicoetto FPM	Union O-Ring FPM	10	10	4,32	
36501 R 0102	Sfera	Ball	2	5	3,59	
36123 R 0135	Kit guarniz. EPDM Perox./PTFE	O-Ring kit Perox. EPDM/PTFE	6-7-8-9-10	1	20,37	
36143 R 0135	Kit guarniz. FPM/PTFE	O-Ring kit FPM/PTFE	6-7-8-9-10	1	31,96	
36123 R 0121	Perno + O-Ring EPDM Perox.	Shaft + Perox. EPDM O-Rings	1-7	5	4,06	

D32 - 1"						
CODE	DESCRIZIONE	DESCRIPTION	Fig.	Q	EUR	
36503 R 0124	Kit maniglia	Handle assembly	4	5	7,57	
36503 R 0104	Ghiera	Union nut	3	10	4,02	
36503 R 0105	Manicotto D32	32 mm connection	5	10	2,25	
36513 R 0105	Manicotto 1" BSP	1" connection BSP	5	10	3,98	
740 R 0329035	O-Ring manicoetto EPDM Perox.	Union O-Ring Perox. EPDM	10	10	3,29	
714 R 0329035	O-Ring manicoetto FPM	Union O-Ring FPM	10	10	5,15	
36503 R 0102	Sfera	Ball	6-7-8-9-10	5	4,75	
36125 R 0135	Kit guarniz. EPDM Perox./PTFE	O-Ring kit Perox. EPDM/PTFE	6-7-8-9-10	1	28,10	
36145 R 0135	Kit guarniz. FPM/PTFE	O-Ring kit FPM/PTFE	1-7	1	43,45	
36125 R 0121	Perno + O-Ring EPDM Perox.	Shaft + Perox. EPDM O-Rings	1-7	5	4,15	

D50 - 1 1/2"						
CODE	DESCRIZIONE	DESCRIPTION	Fig.	Q	EUR	
36505 R 0124	Kit maniglia	Handle assembly	4	4	13,30	
36505 R 0104	Ghiera	Union nut	3	8	6,24	
36505 R 0105	Manicotto D50	50 mm connection	5	8	4,16	
36515 R 0105	Manicotto 1 1/2" BSP	1 1/2" connection BSP	5	8	6,57	
740 R 0470053	O-Ring manicoetto EPDM Perox.	Union O-Ring Perox. EPDM	10	8	5,35	
714 R 0470053	O-Ring manicoetto FPM	Union O-Ring FPM	6-7-8-9-10	8	14,82	
36505 R 0102	Sfera	Ball	6-7-8-9-10	4	7,89	
36127 R 0135	Kit guarniz. EPDM Perox./PTFE	O-Ring kit Perox. EPDM/PTFE	6-7-8-9-10	1	61,78	
36147 R 0135	Kit guarniz. FPM/PTFE	O-Ring kit FPM/PTFE	6-7-8-9-10	1	87,34	
36127 R 0121	Perno + O-Ring EPDM Perox.	Shaft + Perox. EPDM O-Rings	1-7	4	6,52	

D75 - 2 1/2"						
CODE	DESCRIZIONE	DESCRIPTION	Fig.	Q	EUR	
36507 R 0124	Kit maniglia	Handle assembly	4	2	23,65	
36507 R 0104	Ghiera	Union nut	3	4	30,90	
36507 R 0105	Manicotto D75	75 mm connection	5	4	18,94	
36517 R 0105	Manicotto 2 1/2" BSP	2 1/2" connection BSP	5	4	27,19	
740 R 0756053	O-Ring manicoetto EPDM Perox.	Union O-Ring Perox. EPDM	10	4	7,80	
714 R 0756053	O-Ring manicoetto FPM	Union O-Ring FPM	6-7-8-9-10	4	26,32	
36507 R 0102	Sfera	Ball	6-7-8-9-10	2	41,22	
36129 R 0135	Kit guarniz. EPDM Perox./PTFE	O-Ring kit Perox. EPDM/PTFE	6-7-8-9-10	1	97,22	
36149 R 0135	Kit guarniz. FPM/PTFE	O-Ring kit FPM/PTFE	6-7-8-9-10	1	184,58	
36129 R 0121	Perno + O-Ring EPDM Perox.	Shaft + Perox. EPDM O-Rings	1-7	2	16,47	

D110 - 4"						
CODE	DESCRIZIONE	DESCRIPTION	Fig.	Q	EUR	
36509 R 0124	Kit maniglia	Handle assembly	4	1	32,80	
36509 R 0104	Ghiera	Union nut	3	2	111,81	
36509 R 0105	Manicotto D110	110 mm connection	5	2	55,24	
36519 R 0105	Manicotto 4" BSP	4" connection BSP	5	2	75,37	
740 R 1092057	O-Ring manicoetto EPDM Perox.	Union O-Ring Perox. EPDM	6-7-8-9-10	2	12,96	
714 R 1092057	O-Ring manicoetto FPM	Union O-Ring FPM	6-7-8-9-10	2	30,62	
22797 R 0102	Sfera	Ball	1-7	1	83,30	
36131 R 0135	Kit guarniz. EPDM Perox./PTFE	O-Ring kit Perox. EPDM/PTFE	6-7-8-9-10	1	166,85	
36151 R 0135	Kit guarniz. FPM/PTFE	O-Ring kit FPM/PTFE	6-7-8-9-10	1	352,77	
36131 R 0121	Perno + O-Ring EPDM Perox.	Shaft + Perox. EPDM O-Rings	1-7	1	27,43	

D25 - 3/4"						
CODE	DESCRIZIONE	DESCRIPTION	Fig.	Q	EUR	
36502 R 0124	Kit maniglia	Handle assembly	4	5	5,56	
36502 R 0104	Ghiera	Union nut	3	10	3,12	
36502 R 0105	Manicotto D25	25 mm connection	5	10	1,79	
36512 R 0105	Manicotto 3/4" BSP	3/4" connection BSP	5	10	2,96	
740 R 0282035	O-Ring manicoetto EPDM Perox.	Union O-Ring Perox. EPDM	10	10	2,31	
714 R 0282035	O-Ring manicoetto FPM	Union O-Ring FPM	10	10	4,84	
36502 R 0102	Sfera	Ball	2	5	3,95	
36124 R 0135	Kit guarniz. EPDM Perox./PTFE	O-Ring kit Perox. EPDM/PTFE	6-7-8-9-10	1	24,79	
36144 R 0135	Kit guarniz. FPM/PTFE	O-Ring kit FPM/PTFE	6-7-8-9-10	1	40,82	
36124 R 0121	Perno + O-Ring EPDM Perox.	Shaft + Perox. EPDM O-Rings	1-7	5	4,06	

D40 - 1 1/4"						
CODE	DESCRIZIONE	DESCRIPTION	Fig.	Q	EUR	
36504 R 0124	Kit maniglia	Handle assembly	4	5	10,47	
36504 R 0104	Ghiera	Union nut	3	10	4,38	
36504 R 0105	Manicotto D40	40 mm connection	5	10	2,76	
36514 R 0105	Manicotto 1 1/4" BSP	1 1/4" connection BSP	5	10	4,66	
740 R 0407053	O-Ring manicoetto EPDM Perox.	Union O-Ring Perox. EPDM	10	10	4,77	
714 R 0407053	O-Ring manicoetto FPM	Union O-Ring FPM	10	10	10,52	
36504 R 0102	Sfera	Ball	6-7-8-9-10	5	5,96	
36126 R 0135	Kit guarniz. EPDM Perox./PTFE	O-Ring kit Perox. EPDM/PTFE	6-7-8-9-10	1	47,71	
36146 R 0135	Kit guarniz. FPM/PTFE	O-Ring kit FPM/PTFE	1-7	1	70,62	
36126 R 0121	Perno + O-Ring EPDM Perox.	Shaft + Perox. EPDM O-Rings	1-7	5	5,92	

D63 - 2"						
CODE	DESCRIZIONE	DESCRIPTION	Fig.	Q	EUR	
36506 R 0124	Kit maniglia	Handle assembly	4	4	17,61	
36506 R 0104	Ghiera	Union nut	3	8	9,77	
36506 R 0105	Manicotto D63	63 mm connection	5	8	7,00	
36516 R 0105	Manicotto 2" BSP	2" connection BSP	5	8	9,32	
740 R 0597053	O-Ring manicoetto EPDM Perox.	Union O-Ring Perox. EPDM	10	8	5,39	
714 R 0597053	O-Ring manicoetto FPM	Union O-Ring FPM	6-7-8-9-10	8	15,16	
36506 R 0102	Sfera	Ball	6-7-8-9-10	4	12,14	
36128 R 0135	Kit guarniz. EPDM Perox./PTFE	O-Ring kit Perox. EPDM/PTFE	6-7-8-9-10	1	75,88	
36148 R 0135	Kit guarniz. FPM/PTFE	O-Ring kit FPM/PTFE	6-7-8-9-10	1	96,29	
36128 R 0121	Perno + O-Ring EPDM Perox.	Shaft + Perox. EPDM O-Rings	1-7	4	16,14	

D90 - 3"						
CODE	DESCRIZIONE	DESCRIPTION	Fig.	Q	EUR	
36508 R 0124	Kit maniglia	Handle assembly	4	2	29,00	
36508 R 0104	Ghiera	Union nut	3	4	47,04	
36508 R 0105	Manicotto D90	90 mm connection	5	4	31,52	
36518 R 0105	Manicotto 3" BSP	3" connection BSP	5	4	50,96	
740 R 0892057	O-Ring manicoetto EPDM Perox.	Union O-Ring Perox. EPDM	10	4	10,76	
714 R 0894053	O-Ring manicoetto FPM	Union O-Ring FPM	6-7-8-9-10	4	27,67	
36508 R 0102	Sfera	Ball	6-7-8-9-10	2	69,08	
36130 R 0135	Kit guarniz. EPDM Perox./PTFE	O-Ring kit Perox. EPDM/PTFE	6-7-8-9-10	1	135,63	
36150 R 0135	Kit guarniz. FPM/PTFE	O-Ring kit FPM/PTFE	6-7-8-9-10	1	226,62	
36130 R 0121	Perno + O-Ring EPDM Perox.	Shaft + Perox. EPDM O-Rings	1-7	2	17,29	

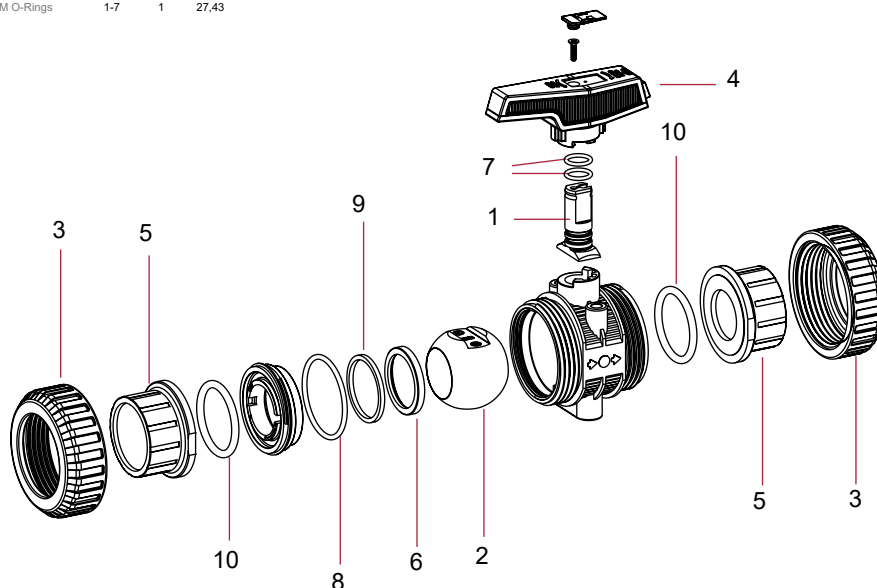

Accessori PVC-U

Valvole PVC-U

Accessori PVC-C

Valvole PVC-C

Valvole Extreme

Evacuazione

Ricambi

**VALVOLE A SFERA IN PVC-U SERIES STANDARD E INDUSTRIAL -
PVC-U BALL VALVES STANDARD & INDUSTRIAL SERIES**

C01 | 007 900

D16 - 3/4" / D20 - 1/2" (PN 16)					
CODE	DESCRIZIONE	DESCRIPTION	Fig.	Q	EUR
02453 R 0121	Perno + O-Ring EPDM	Shaft + EPDM O-Rings	1+7	5	1,38
02453 R 0102	Sfera	Ball	2	5	2,07
02453 R 0104	Ghiera	Union nut	3	10	1,99
02453 R 0124	Kit maniglia	Handle assembly	4	5	1,74
05352 R 0105	Manicotto D16	16 mm connection	5	10	1,24
02453 R 0105	Manicotto D20	20 mm connection	5	10	1,24
05353 R 0105	Manicotto 1/2" BSP	1/2" connection BSP	5	10	1,82
02462 R 0105	Manicotto 1/2" BSP	1/2" connection BSP	5	10	1,82
02453 R 0107	Guarniz. sagomata sfera HDPE	Ball seat HDPE	6	10	0,95
02470 R 0115	Guarniz. sagomata sfera PTFE	Ball seat PTFE	6	10	1,82
723 R 0093018	O-Ring perno EPDM	Shaft O-Ring EPDM	7	10	0,45
723 R 0266026	O-Ring corpo EPDM (Standard)	Body O-Ring EPDM (Standard)	8	10	0,66
723 R 0238026	O-Ring corpo EPDM (Industrial)	Body O-Ring EPDM (Industrial)	8	10	0,66
02453 R 0118	Guarniz. ammortizzatrice EPDM	Seat O-Ring EPDM	9	10	0,66
723 R 0202035	O-Ring manicotto EPDM	Union O-Ring EPDM	10	10	0,76
02453 R 0129	Kit guarniz. EPDM (Standard)	O-Ring kit EPDM (Standard)	7+8+9+10	1	3,85
18435 R 0129	Kit guarniz. EPDM (Industrial)	O-Ring kit EPDM (Industrial)	7+8+9+10	1	4,06
714 R 0093018	O-Ring perno FPM	Shaft O-Ring FPM	7	10	0,95
714 R 0266026	O-Ring corpo FPM (Standard)	Body O-Ring FPM (Standard)	8	10	2,25
714 R 0238026	O-Ring corpo FPM (Industrial)	Body O-Ring FPM (Industrial)	8	10	2,25
02486 R 0118	Guarniz. ammortizzatrice FPM	Seat O-Ring FPM	9	10	1,73
714 R 0202035	O-Ring manicotto FPM	Union O-Ring FPM	10	10	4,32
02486 R 0129	Kit guarniz. FPM (Standard)	O-Ring kit FPM (Standard)	7+8+9+10	1	13,91
18445 R 0129	Kit guarniz. FPM (Industrial)	O-Ring kit FPM (Industrial)	7+8+9+10	1	13,91
18435 R 0108	Chiave di regolazion	Adjusting tool	11	5	4,06

D32 - 1" (PN 16)					
CODE	DESCRIZIONE	DESCRIPTION	Fig.	Q	EUR
02455 R 0121	Perno + O-Ring EPDM	Shaft + EPDM O-Rings	1+7	5	1,53
02455 R 0102	Sfera	Ball	2	5	3,34
02455 R 0104	Ghiera	Union nut	3	10	2,74
02455 R 0124	Kit maniglia	Handle assembly	4	5	2,45
02455 R 0105	Manicotto D32	32 mm connection	5	10	1,99
02464 R 0105	Manicotto 1" BSP	1" connection BSP	5	10	2,74
02455 R 0107	Guarniz. sagomata sfera HDPE	Ball seat HDPE	6	10	0,95
02472 R 0115	Guarniz. sagomata sfera PTFE	Ball seat PTFE	6	10	3,39
723 R 0120025	O-Ring perno EPDM	Shaft O-Ring EPDM	7	10	0,45
723 R 0378026	O-Ring corpo EPDM	Body O-Ring EPDM	8	10	0,66
02455 R 0118	Guarniz. ammortizzatrice EPDM	Seat O-Ring EPDM	9	10	1,26
723 R 0329035	O-Ring manicotto EPDM	Union O-Ring EPDM	10	10	1,14
02455 R 0129	Kit guarniz. EPDM	O-Ring kit EPDM	7+8+9+10	1	4,18
714 R 0120025	O-Ring perno FPM	Shaft O-Ring FPM	7	10	1,79
714 R 0378026	O-Ring corpo FPM	Body O-Ring FPM	8	10	3,11
02488 R 0118	Guarniz. ammortizzatrice FPM	Seat O-Ring FPM	9	10	3,50
714 R 0329035	O-Ring manicotto FPM	Union O-Ring FPM	10	10	5,15
02488 R 0129	Kit guarniz. FPM	O-Ring kit FPM	7+8+9+10	1	22,48
18437 R 0108	Chiave di regolazion	Adjusting tool	11	5	4,24

D50 - 1 1/2" (PN 16)					
CODE	DESCRIZIONE	DESCRIPTION	Fig.	Q	EUR
02457 R 0121	Perno + O-Ring EPDM	Shaft + EPDM O-Rings	1+7	4	2,11
02457 R 0102	Sfera	Ball	2	4	6,18
02457 R 0104	Ghiera	Union nut	3	8	5,87
02457 R 0124	Kit maniglia	Handle assembly	4	4	3,57
02457 R 0105	Manicotto D50	50 mm connection	5	8	3,42
02466 R 0105	Manicotto 1 1/2" BSP	1 1/2" connection BSP	5	8	4,48
02457 R 0107	Guarniz. sagomata sfera HDPE	Ball seat HDPE	6	8	1,30
02474 R 0115	Guarniz. sagomata sfera PTFE	Ball seat PTFE	6	8	6,94
723 R 0155026	O-Ring perno EPDM	Shaft O-Ring EPDM	7	10	0,45
723 R 0619035	O-Ring corpo EPDM	Body O-Ring EPDM	8	5	1,17
02457 R 0118	Guarniz. ammortizzatrice EPDM	Seat O-Ring EPDM	9	8	0,95
723 R 0470053	O-Ring manicotto EPDM	Union O-Ring EPDM	10	10	1,82
02457 R 0129	Kit guarniz. EPDM	O-Ring kit EPDM	7+8+9+10	1	5,50
714 R 0155026	O-Ring perno FPM	Shaft O-Ring FPM	7	10	2,25
714 R 0619035	O-Ring corpo FPM	Body O-Ring FPM	8	5	21,16
02490 R 0118	Guarniz. ammortizzatrice FPM	Seat O-Ring FPM	9	8	5,10
714 R 0470053	O-Ring manicotto FPM	Union O-Ring FPM	10	10	14,82
02490 R 0129	Kit guarniz. FPM	O-Ring kit FPM	7+8+9+10	1	43,22
18439 R 0108	Chiave di regolazion	Adjusting tool	11	4	5,33

D75 - 2 1/2" (PN 10)					
CODE	DESCRIZIONE	DESCRIPTION	Fig.	Q	EUR
02459 R 0121	Perno + O-Ring EPDM	Shaft + EPDM O-Rings	1+7	2	7,62
02459 R 0102	Sfera	Ball	2	2	17,55
02459 R 0104	Ghiera	Union nut	3	4	17,99
02459 R 0124	Kit maniglia	Handle assembly	4	2	10,42
02459 R 0105	Manicotto D75	75 mm connection	5	4	8,08
02468 R 0105	Manicotto 2 1/2" BSP	2 1/2" connection BSP	5	4	14,51
02459 R 0107	Guarniz. sagomata sfera HDPE	Ball seat HDPE	6	4	2,43
02476 R 0115	Guarniz. sagomata sfera PTFE	Ball seat PTFE	6	4	12,88
723 R 0234035	O-Ring perno EPDM	Shaft O-Ring EPDM	7	10	0,66
723 R 0978053	O-Ring corpo EPDM	Body O-Ring EPDM	8	2	2,74
02459 R 0118	Guarniz. ammortizzatrice EPDM	Seat O-Ring EPDM	9	4	1,63
723 R 0756053	O-Ring manicotto EPDM	Union O-Ring EPDM	10	5	4,90
02459 R 0129	Kit guarniz. EPDM	O-Ring kit EPDM	7+8+9+10	1	8,72
714 R 0234035	O-Ring perno FPM	Shaft O-Ring FPM	7	10	3,40
714 R 0978053	O-Ring corpo FPM	Body O-Ring FPM	8	2	25,11
02492 R 0118	Guarniz. ammortizzatrice FPM	Seat O-Ring FPM	9	4	10,00
714 R 0756053	O-Ring manicotto FPM	Union O-Ring FPM	10	5	26,32
02492 R 0129	Kit guarniz. FPM	O-Ring kit FPM	7+8+9+10	1	77,27
18441 R 0108	Chiave di regolazion	Adjusting tool	11	2	6,22

D110 - 4" (PN 10)					
CODE	DESCRIZIONE	DESCRIPTION	Fig.	Q	EUR
22797 R 0121	Perno + O-Ring EPDM	Shaft + EPDM O-Rings	1+7	1	30,48
22797 R 0102	Sfera	Ball	2	1	83,30
22797 R 0104	Ghiera valvola D11C	Union nut 110 mm	3	2	41,22
22797 R 0124	Kit maniglia	Handle assembly	4	1	15,66
22797 R 0105	Manicotto D110	110 mm connection	5	2	30,51
22796 R 0105	Manicotto 4" BSP	4" connection BSP	5	2	43,38
22797 R 0107	Guarniz. sagomata sfera HDPE	Ball seat HDPE	6	2	3,11
22065 R 0115	Guarniz. sagomata sfera PTFE	Ball seat PTFE	6	2	51,49
723 R 0266035	O-Ring perno EPDM	Shaft O-Ring EPDM	7	10	0,66
723 R 1600040	O-Ring corpo EPDM	Body O-Ring EPDM	8	1	4,16
22797 R 0118	Guarniz. ammortizzatrice EPDM	Seat O-Ring EPDM	9	2	2,50
723 R 1092057	O-Ring manicotto EPDM	Union O-Ring EPDM	10	2	8,85
22797 R 0129	Kit guarniz. EPDM	O-Ring kit EPDM	7+8+9+10	1	13,19
714 R 0266035	O-Ring perno FPM	Shaft O-Ring FPM	7	10	3,61
714 R 1600040	O-Ring corpo FPM	Body O-Ring FPM	8	1	21,63
22801 R 0118	Guarniz. ammortizzatrice FPM	Seat O-Ring FPM	9	2	35,73
714 R 1092057	O-Ring manicotto FPM	Union O-Ring FPM	10	2	30,62
22801 R 0129	Kit guarniz. FPM	O-Ring kit FPM	7+8+9+10	1	115,30
22799 R 0108	Chiave di regolazion	Adjusting tool	11	2	36,34

D25 - 3/4" (PN 16)					
CODE	DESCRIZIONE	DESCRIPTION	Fig.	Q	EUR
02454 R 0121	Perno + O-Ring EPDM	Shaft + EPDM O-Rings	1+7	5	1,38
02454 R 0102	Sfera	Ball	2	5	2,50
02454 R 0104	Ghiera	Union nut	3	10	2,38
02454 R 0124	Kit maniglia	Handle assembly	4	5	1,99
02454 R 0105	Manicotto D25	25 mm connection	5	10	1,38
02463 R 0105	Manicotto 3/4" BSP	3/4" connection BSP	5	10	2,11
02454 R 0107	Guarniz. sagomata sfera HDPE	Ball seat HDPE	6	10	0,95
02471 R 0115	Guarniz. sagomata sfera PTFE	Ball seat PTFE	6	10	3,02
723 R 0110118	O-Ring perno EPDM	Shaft O-Ring EPDM	7	10	0,29
723 R 0330026	O-Ring corpo EPDM	Body O-Ring EPDM	8	10	0,66
02454 R 0118	Guarniz. ammortizzatrice EPDM	Seat O-Ring EPDM	9	10	0,73
723 R 0282035	O-Ring manicotto EPDM	Union O-Ring EPDM	10	10	0,94
02454 R 0129	Kit guarniz. EPDM	O-Ring kit EPDM	7+8+9+10	1	4,02
714 R 0110118	O-Ring perno FPM	Shaft O-Ring FPM	7	10	1,30
714 R 0330026	O-Ring corpo FPM	Body O-Ring FPM	8	10	3,39
02487 R 0118	Guarniz. ammortizzatrice FPM	Seat O-Ring FPM	9	10	2,74
714 R 0282035	O-Ring manicotto FPM	Union O-Ring FPM	10	10	4,84
02487 R 0129	Kit guarniz. FPM	O-Ring kit FPM	7+8+9+10	1	18,52
18435 R 0108	Chiave di regolazion	Adjusting tool	11	1	4,06

D40 - 1 1/2" (PN 16)					
CODE	DESCRIZIONE	DESCRIPTION	Fig.	Q	EUR
02456 R 0121	Perno + O-Ring EPDM	Shaft + EPDM O-Rings	1+7	5	1,63
02456 R 0102	Sfera	Ball	2	5	4,06
02456 R 0104	Ghiera	Union nut	3	10	3,78
02456 R 0124	Kit maniglia	Handle assembly	4	5	2,74
02456 R 0105	Manicotto D40	40 mm connection	5	10	2,43
02465 R 0105	Manicotto 1 1/2" BSP	1 1/2" connection BSP	5	10	3,16
02456 R 0107	Guarniz. sagomata sfera HDPE	Ball seat HDPE	6	10	1,08
02473 R 0115	Guarniz. sagomata sfera PTFE	Ball seat PTFE	6	10	6,18
723 R 0139026	O-Ring perno EPDM	Shaft O-Ring EPDM	7	10	0,59
723 R 0505026	O-Ring corpo EPDM	Body O-Ring EPDM	8	5	0,95
02456 R 0118	Guarniz. ammortizzatrice EPDM	Seat O-Ring EPDM	9	10	0,95
723 R 0407053	O-Ring manicotto EPDM	Union O-Ring EPDM	10	10	1,35
02456 R 0129	Kit guarniz. EPDM	O-Ring kit EPDM	7+8+9+10	1	5,40
714 R 0139026	O-Ring perno FPM	Shaft O-Ring FPM	7	10	1,25
714 R 0505026	O-Ring corpo FPM	Body O-Ring FPM	8	5	5,65
02489 R 0118	Guarniz. ammortizzatrice FPM	Seat O-Ring FPM	9	10	4,33
714 R 0407053	O-Ring manicotto FPM	Union O-Ring FPM	10	10	10,52
02489 R 0129	Kit guarniz. FPM	O-Ring kit FPM	7+8+9+10	1	34,57
18437 R 0108	Chiave di regolazion	Adjusting tool	11	1	4,24

D63 - 2" (PN 16)					
CODE	DESCRIZIONE	DESCRIPTION	Fig.	Q	EUR
02458 R 0121	Perno + O-Ring EPDM	Shaft + EPDM O-Rings	1+7	4	2,11
02458 R 0102	Sfera	Ball	2	4	8,72
02458 R 0104	Ghiera	Union nut	3	8	6,39
02458 R 0124	Kit maniglia	Handle assembly	4	4	4,14
02458 R 0105	Manicotto D63	63 mm connection	5	8	4,14
02467 R 0105	Manicotto 2" BSP	2" connection BSP	5	8	5,63
02458 R 0107	Guarniz. sagomata sfera HDPE	Ball seat HDPE	6	8	1,63
02475 R 0115	Guarniz. sagomata sfera PTFE	Ball seat PTFE	6	8	6,94
723 R 0155026	O-Ring perno EPDM	Shaft O-Ring EPDM	7	10	0,45
723 R 0758035	O-Ring corpo EPDM	Body O-Ring EPDM	8	5	1,30
02458 R 0118	Guarniz. ammortizzatrice EPDM	Seat O-Ring EPDM	9	8	1,08
723 R 0597053	O-Ring manicotto EPDM	Union O-Ring EPDM	10	5	2,05
02458 R 0129	Kit guarniz. EPDM	O-Ring kit EPDM	7+8+9+10	1	6,31
714 R 0155026	O-Ring perno FPM	Shaft O-Ring FPM	7	10	2,25
714 R 0758035	O-Ring corpo FPM	Body O-Ring FPM	8	5	10,72
02491 R 0118	Guarniz. ammortizzatrice FPM	Seat O-Ring FPM	9	8	8,95
714 R 0597053	O-Ring manicotto FPM	Union O-Ring FPM	10	5	15,16
02491 R 0129	Kit guarniz. FPM	O-Ring kit FPM	7+8+9+10	1	57,20
18439 R 0108	Chiave di regolazion	Adjusting tool	11	4	5,33

D90 - 3" / D110 - 4" (DN 80) (PN 10)					
CODE	DESCRIZIONE	DESCRIPTION	Fig.	Q	EUR
02460 R 0121	Perno + O-Ring EPDM	Shaft + EPDM O-Rings	1+7	1	11,40
02460 R 0102	Sfera	Ball	2	1	31,86
02460 R 0104	Ghiera valvola D9C	Union nut 90 mm	3	2	25,23
02461 R 0104	Ghiera valvola D110 (DN 80)	Union nut 110 mm (DN 80)	3	2	27,13
02460 R 0124	Kit maniglia	Handle assembly	4	1	15,19
02460 R 0105	Manicotto D90	90 mm connection	5	2	13,41
02461 R 0105	Manicotto D110 (DN 80)	110 mm connection (DN 80)	5	2	11,61
02469 R 0105	Manicotto 3" BSP	3" connection BSP	5	2	19,59
0					

VALVOLE A SFERA IN PVC-U SERIE UNIBLOCK - PVC-U BALL VALVES UNIBLOCK SERIES

C01 | 007 900

D20 - 1/2" (UNIBLOCK)					
CODE	DESCRIZIONE	DESCRIPTION	Fig.	Q	EUR
02453 R 0121	Perno + O-Ring EPDM	Shaft + EPDM O-Rings	1+7	5	1,38
02453 R 0102	Sfera	Ball	2	5	2,07
22773 R 0104	Ghiera	Union nut	3	10	1,53
22773 R 0124	Kit maniglia	Handle assembly	4	5	1,29
22773 R 0105	Manicotto D20	20 mm connection	5	10	0,78
22791 R 0105	Manicotto 1/2" BSF	1/2" connection BSF	5	10	0,95
02453 R 0107	Guarniz. sagomata sfera HDPE	Ball seat HDPE	6	10	0,95
723 R 0093018	O-Ring perno EPDM	Shaft O-Ring EPDM	7	10	0,45
723 R 0266026	O-Ring corpo EPDM	Body O-Ring EPDM	8	5	0,66
02453 R 0118	Guarniz. ammortizzatrice EPDM	Seat O-Ring EPDM	9	10	0,66
723 R 0202035	O-Ring manicotto EPDM	Union O-Ring EPDM	10	10	0,76
02453 R 0129	Kit guarniz. EPDM	O-Ring kit EPDM	7+8+9+10	1	3,85
22785 R 0105	Manicotto macho 1/2" BSF	1/2" male connection BSF	12	10	1,11

D32 - 1" (UNIBLOCK)					
CODE	DESCRIZIONE	DESCRIPTION	Fig.	Q	EUR
02455 R 0121	Perno + O-Ring EPDM	Shaft + EPDM O-Rings	1+7	5	1,53
02455 R 0102	Sfera	Ball	2	5	3,34
22775 R 0104	Ghiera	Union nut	3	10	2,09
22775 R 0124	Kit maniglia	Handle assembly	4	5	2,09
22775 R 0105	Manicotto D32	32 mm connection	5	10	1,17
22793 R 0105	Manicotto 1" BSF	1" connection BSF	5	10	1,31
02455 R 0107	Guarniz. sagomata sfera HDPE	Ball seat HDPE	6	10	0,95
723 R 0120025	O-Ring perno EPDM	Shaft O-Ring EPDM	7	10	0,45
723 R 0378026	O-Ring corpo EPDM	Body O-Ring EPDM	8	5	0,66
02455 R 0118	Guarniz. ammortizzatrice EPDM	Seat O-Ring EPDM	9	10	1,26
723 R 0329035	O-Ring manicotto EPDM	Union O-Ring EPDM	10	10	1,14
02455 R 0129	Kit guarniz. EPDM	O-Ring kit EPDM	7+8+9+10	1	4,18
22787 R 0105	Manicotto macho 1" BSF	1" male connection BSF	12	10	1,54

D50 - 1 1/2" (UNIBLOCK)					
CODE	DESCRIZIONE	DESCRIPTION	Fig.	Q	EUR
02502 R 0121	Perno + O-Ring EPDM	Shaft + EPDM O-Rings	1+7	4	2,07
02502 R 0102	Sfera	Ball	2	4	5,32
11375 R 0104	Ghiera	Union nut	3	4	3,87
11375 R 0124	Kit maniglia	Handle assembly	4	4	3,87
11375 R 0105	Manicotto D50	50 mm connection	5	4	3,34
11377 R 0105	Manicotto 1 1/2" BSF	1 1/2" connection BSF	5	4	3,60
11375 R 0107	Guarniz. sagomata sfera HDPE	Ball seat HDPE	6	8	1,31
723 R 0155026	O-Ring perno EPDM	Shaft O-Ring EPDM	7	10	0,45
723 R 0567035	O-Ring corpo EPDM	Body O-Ring EPDM	8	5	1,08
02457 R 0118	Guarniz. ammortizzatrice EPDM	Seat O-Ring EPDM	9	8	0,95
723 R 0470053	O-Ring manicotto EPDM	Union O-Ring EPDM	10	10	1,82
11375 R 0129	Kit guarniz. EPDM	O-Ring kit EPDM	7+8+9+10	1	4,79
11374 R 0105	Manicotto macho 1 1/2" BSF	1 1/2" male connection BSF	12	4	4,15

D75 - 2" (UNIBLOCK)					
CODE	DESCRIZIONE	DESCRIPTION	Fig.	Q	EUR
02459 R 0121	Perno + O-Ring EPDM	Shaft + EPDM O-Rings	1+7	2	7,62
02459 R 0102	Sfera	Ball	2	2	17,55
22777 R 0104	Ghiera	Union nut	3	4	14,87
22777 R 0124	Kit maniglia	Handle assembly	4	2	8,53
22777 R 0105	Manicotto D75	75 mm connection	5	4	12,22
22795 R 0105	Manicotto 2" BSF	2" connection BSF	5	4	11,19
02459 R 0107	Guarniz. sagomata sfera HDPE	Ball seat HDPE	6	4	2,43
723 R 0234035	O-Ring perno EPDM	Shaft O-Ring EPDM	7	10	0,66
723 R 0978053	O-Ring corpo EPDM	Body O-Ring EPDM	8	2	2,74
02459 R 0118	Guarniz. ammortizzatrice EPDM	Seat O-Ring EPDM	9	4	1,63
723 R 0756053	O-Ring manicotto EPDM	Union O-Ring EPDM	10	5	4,90
02459 R 0129	Kit guarniz. EPDM	O-Ring kit EPDM	7+8+9+10	1	8,72
22789 R 0105	Manicotto macho 2" BSF	2" male connection BSF	12	4	13,12

D110 - 4" (UNIBLOCK)					
CODE	DESCRIZIONE	DESCRIPTION	Fig.	Q	EUR
22797 R 0121	Perno + O-Ring EPDM	Shaft + EPDM O-Rings	1+7	1	30,48
22797 R 0102	Sfera	Ball	2	1	83,30
22797 R 0104	Ghiera	Union nut	3	2	41,22
22797 R 0124	Kit maniglia	Handle assembly	4	1	15,66
22797 R 0105	Manicotto D110	110 mm connector	5	2	30,51
22798 R 0105	Manicotto 4"	4" connection BSF	5	2	43,38
22797 R 0107	Guarniz. sagomata sfera HDPE	Ball seat HDPE	6	2	3,11
723 R 0266035	O-Ring perno EPDM	Shaft O-Ring EPDM	7	10	0,66
723 R 1550053	O-Ring corpo EPDM	Body O-Ring EPDM	8	1	4,39
22797 R 0118	Guarniz. ammortizzatrice EPDM	Seat O-Ring EPDM	9	2	2,50
723 R 1092057	O-Ring manicotto EPDM	Union O-Ring EPDM	10	2	8,85
36728 R 0129	Kit guarniz. EPDM	O-Ring kit EPDM	7+8+9+10	1	11,39
36730 R 0105	Manicotto macho 4"	4" male connection BSF	12	2	39,92

D25 - 3/4" (UNIBLOCK)					
CODE	DESCRIZIONE	DESCRIPTION	Fig.	Q	EUR
02454 R 0121	Perno + O-Ring EPDM	Shaft + EPDM O-Rings	1+7	5	1,38
02454 R 0102	Sfera	Ball	2	5	2,50
22774 R 0104	Ghiera	Union nut	3	10	1,88
22774 R 0124	Kit maniglia	Handle assembly	4	5	1,53
22774 R 0105	Manicotto D25	25 mm connection	5	10	0,78
22792 R 0105	Manicotto 3/4"	3/4" connection BSF	5	10	0,95
02454 R 0107	Guarniz. sagomata sfera HDPE	Ball seat HDPE	6	10	0,95
723 R 0110108	O-Ring perno EPDM	Shaft O-Ring EPDM	7	10	0,29
723 R 0330026	O-Ring corpo EPDM	Body O-Ring EPDM	8	5	0,66
02454 R 0118	Guarniz. ammortizzatrice EPDM	Seat O-Ring EPDM	9	10	0,73
723 R 0282035	O-Ring manicotto EPDM	Union O-Ring EPDM	10	10	0,94
02454 R 0129	Kit guarniz. EPDM	O-Ring kit EPDM	7+8+9+10	1	4,02
22786 R 0105	Manicotto macho 3/4"	3/4" male connection BSF	12	10	1,11

D40 - 1 1/4" (UNIBLOCK)					
CODE	DESCRIZIONE	DESCRIPTION	Fig.	Q	EUR
02456 R 0121	Perno + O-Ring EPDM	Shaft + EPDM O-Rings	1+7	5	1,63
02456 R 0102	Sfera	Ball	2	5	4,06
22776 R 0104	Ghiera	Union nut	3	10	3,12
22776 R 0124	Kit maniglia	Handle assembly	4	5	2,16
22776 R 0105	Manicotto D40	40 mm connection	5	10	1,85
22794 R 0105	Manicotto 1 1/4"	1 1/4" connection BSF	5	10	1,97
02456 R 0107	Guarniz. sagomata sfera HDPE	Ball seat HDPE	6	10	1,08
723 R 0139026	O-Ring perno EPDM	Shaft O-Ring EPDM	7	10	0,59
723 R 0505026	O-Ring corpo EPDM	Body O-Ring EPDM	8	5	0,95
02456 R 0118	Guarniz. ammortizzatrice EPDM	Seat O-Ring EPDM	9	10	0,95
723 R 0407053	O-Ring manicotto EPDM	Union O-Ring EPDM	10	10	1,35
02456 R 0129	Kit guarniz. EPDM	O-Ring kit EPDM	7+8+9+10	1	5,40
22788 R 0105	Manicotto macho 1 1/4"	1 1/4" male connection BSF	12	10	2,39

D63 - 2" (UNIBLOCK)					
CODE	DESCRIZIONE	DESCRIPTION	Fig.	Q	EUR
02457 R 0121	Perno + O-Ring EPDM	Shaft + EPDM O-Rings	1+7	4	2,11
02458 R 0102	Sfera	Ball	2	4	8,72
15826 R 0104	Ghiera	Union nut	3	4	9,02
15826 R 0124	Kit maniglia	Handle assembly	4	4	4,70
15826 R 0105	Manicotto D63	63 mm connection	5	4	5,33
15829 R 0105	Manicotto 2"	2" connection BSF	5	4	5,99
02458 R 0107	Guarniz. sagomata sfera HDPE	Ball seat HDPE	6	8	1,63
723 R 0155026	O-Ring perno EPDM	Shaft O-Ring EPDM	7	10	0,45
723 R 0758035	O-Ring corpo EPDM	Body O-Ring EPDM	8	5	1,30
02458 R 0118	Guarniz. ammortizzatrice EPDM	Seat O-Ring EPDM	9	8	1,08
723 R 0597053	O-Ring manicotto EPDM	Union O-Ring EPDM	10	10	2,05
15826 R 0129	Kit guarniz. EPDM	O-Ring kit EPDM	7+8+9+10	1	5,70
15827 R 0105	Manicotto macho 2"	2" male connection BSF	12	4	7,80

D90 - 3" (UNIBLOCK)					
CODE	DESCRIZIONE	DESCRIPTION	Fig.	Q	EUR
02460 R 0121	Perno + O-Ring EPDM	Shaft + EPDM O-Rings	1+7	1	11,40
02460 R 0102	Sfera	Ball	2	1	31,86
22778 R 0104	Ghiera	Union nut	3	2	20,88
22778 R 0124	Kit maniglia	Handle assembly	4	1	12,11
22796 R 0105	Manicotto D90	90 mm connection	5	2	9,74
22796 R 0105	Manicotto 3"	3" connection BSF	5	2	15,91
02460 R 0107	Guarniz. sagomata sfera HDPE	Ball seat HDPE	6	2	3,78
723 R 0266035	O-Ring perno EPDM	Shaft O-Ring EPDM	7	10	0,66
723 R 1238053	O-Ring corpo EPDM	Body O-Ring EPDM	8	1	5,33
02460 R 0118	Guarniz. ammortizzatrice EPDM	Seat O-Ring EPDM	9	2	2,43
723 R 0914053	O-Ring manicotto EPDM	Union O-Ring EPDM	10	2	6,40
02460 R 0129	Kit guarniz. EPDM	O-Ring kit EPDM	7+8+9+10	1	11,25
22790 R 0105	Manicotto macho 3"	3" male connection BSF	12	2	18,69

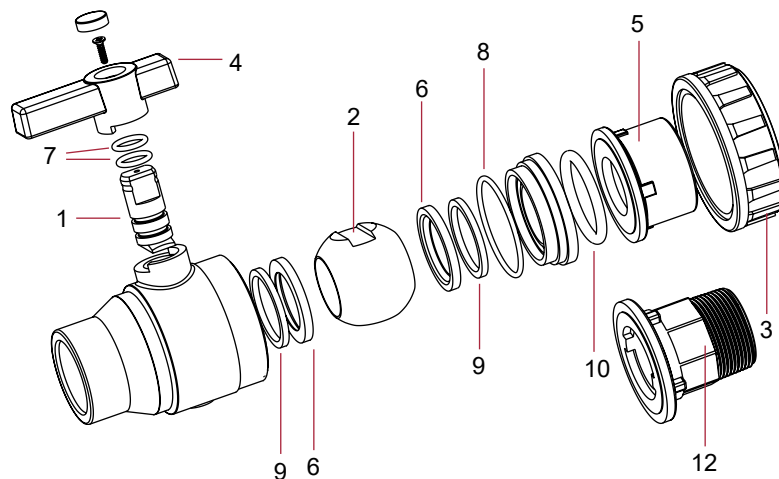

Accessori PVC-U
Valvole PVC-U
Accessori PVC-C
Valvole PVC-C
Valvole Extreme
Evacuazione
Ricambi

VALVOLE A SFERA IN PVC-U SERIE E-QUA - PVC-U BALL VALVES E-QUA SERIES

C01 | 007 900

D50 - 1 1/2" (PN 12) e-QUA					
CODE	DESCRIZIONE	DESCRIPTION	Fig.	Q	EUR
41544 R 0124	Kit maniglia standard	Standard handle assembly	4	4	6,75
41941 R 0104	Ghiera	Union nut	3	8	6,38
36505 R 0105	Manicotto D50	50 mm connection	5	8	4,16
36515 R 0105	Manicotto 1 1/2" BSP	1 1/2" connection BSP	5	8	6,57
723 R 0470053	O-Ring manicotto EPDM	Union O-Ring EPDM	10	8	1,82
36505 R 0102	Sfera	Ball	2	4	7,89
36505 R 0135	Kit guarniz. EPDM/PE	O-Ring kit EPDM/PE	6+7+8+9+10	1	13,55
36505 R 0121	Perno + O-Ring EPDM	Shaft + EPDM O-Rings	1+7	4	4,37

D63 - 2" (PN 12) e-QUA					
CODE	DESCRIZIONE	DESCRIPTION	Fig.	Q	EUR
41545 R 0124	Kit maniglia standard	Standard handle assembly	4	4	7,13
41545 R 0104	Ghiera	Union nut	3	8	10,04
36506 R 0105	Manicotto D63	63 mm connection	5	8	7,00
36516 R 0105	Manicotto 2" BSP	2" connection BSP	5	8	9,32
723 R 0597053	O-Ring manicotto EPDM	Union O-Ring EPDM	10	8	2,05
36506 R 0102	Sfera	Ball	2	4	12,14
36506 R 0135	Kit guarniz. EPDM/PE	O-Ring kit EPDM/PE	6+7+8+9+10	1	14,26
36506 R 0121	Perno + O-Ring EPDM	Shaft + EPDM O-Rings	1+7	4	4,93

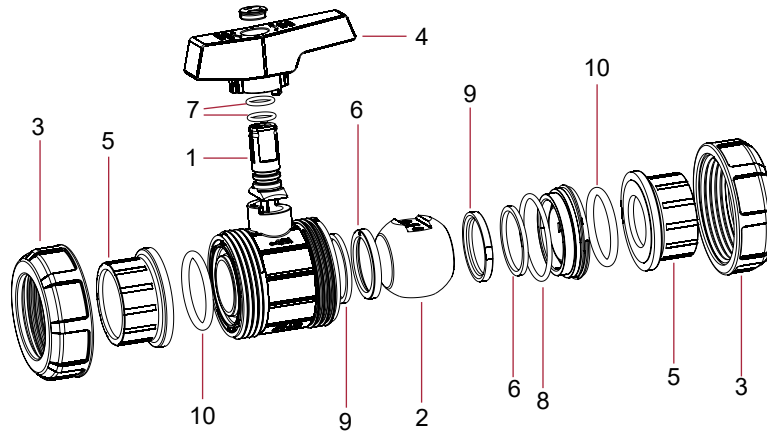

VALVOLE A SFERA IN PVC-U SERIE PN 10 - PVC-U BALL VALVES PN 10 SERIES

C01 | 007 900

D50 - 1 1/2" (PN 10)					
CODE	DESCRIZIONE	DESCRIPTION	Fig.	Q	EUR
02502 R 0121	Perno + O-Ring EPDM	Shaft + EPDM O-Rings	1+7	4	2,07
02502 R 0102	Sfera	Ball	2	4	5,32
02502 R 0104	Ghiera	Union nut	3	8	4,37
02502 R 0124	Kit maniglia	Handle assembly	4	4	4,14
02502 R 0105	Manicotto D50	50 mm connection	5	8	3,67
02504 R 0105	Manicotto 1 1/2" BSP	1 1/2" BSP connector	5	8	6,79
02502 R 0107	Guarniz. sagomata sfera HDPE	Ball seat HDPE	6	8	1,30
723 R 0155026	O-Ring perno EPDM	Shaft O-Ring EPDM	7	10	0,45
723 R 0567035	O-Ring corpo EPDM	Body O-Ring EPDM	8	5	1,08
02457 R 0118	Guarniz. ammortizzatrice EPDM	Seat O-Ring EPDM	9	8	0,95
723 R 0470053	O-Ring manicotto EPDM	Union O-Ring EPDM	10	10	1,82
02502 R 0129	Kit guarniz. EPDM	O-Ring kit EPDM	7+8+9+10	1	5,40

D63 - 2" (PN 10)					
CODE	DESCRIZIONE	DESCRIPTION	Fig.	Q	EUR
02457 R 0121	Perno + O-Ring EPDM	Shaft + EPDM O-Rings	1+7	4	2,11
02458 R 0102	Sfera	Ball	2	4	8,72
02503 R 0104	Ghiera	Union nut	3	8	7,94
02503 R 0124	Kit maniglia	Handle assembly	4	4	5,00
02503 R 0105	Manicotto D63	63 mm connection	5	8	4,50
02505 R 0105	Manicotto 2" BSP	2" connection BSP	5	8	6,47
02458 R 0107	Guarniz. sagomata sfera HDPE	Ball seat HDPE	6	8	1,63
723 R 0155026	O-Ring perno EPDM	Shaft O-Ring EPDM	7	10	0,45
723 R 0758035	O-Ring corpo EPDM	Body O-Ring EPDM	8	5	1,30
02458 R 0118	Guarniz. ammortizzatrice EPDM	Seat O-Ring EPDM	9	8	1,08
723 R 0597053	O-Ring manicotto EPDM	Union O-Ring EPDM	10	5	2,05
02458 R 0129	Kit guarniz. EPDM	O-Ring kit EPDM	7+8+9+10	1	6,31

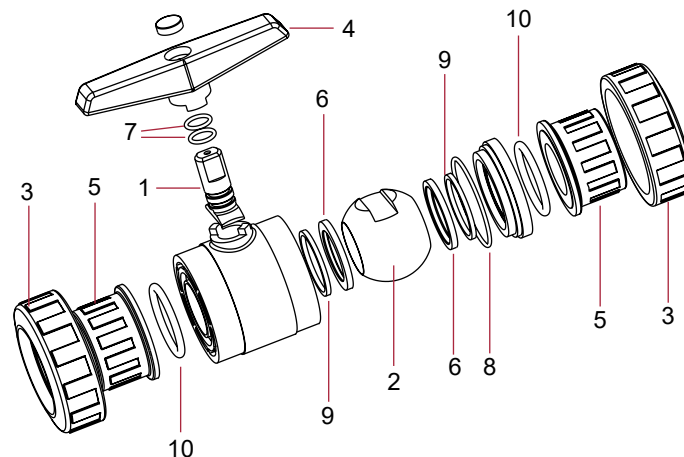

VALVOLE A SFERA IN PVC-C SERIE INDUSTRIAL - PVC-C BALL VALVES INDUSTRIAL SERIES

C01 | 007 900

D16 - 3/8" / D20 - 1/2" (PN 16)					
CODE	DESCRIZIONE	DESCRIPTION	Fig.	Q	EUR
22805 R 0121	Perno + O-Ring EPDM Perox	Shaft + EPDM O-Rings	1+7	5	3,29
22805 R 0102	Sfera	Ball	2	5	6,48
22805 R 0104	Ghiera	Union nut	3	10	3,36
22805 R 0124	Kit maniglia	Handle assembly	4	5	1,85
22804 R 0105	Manicotto D16	16 mm connection	5	10	3,47
22805 R 0105	Manicotto D20	20 mm connection	5	10	3,47
22814 R 0105	Manicotto 3/8" BSP	3/8" connection BSF	5	10	5,42
22815 R 0105	Manicotto 1/2" BSP	1/2" connection BSF	5	10	5,42
22805 R 0115	Guarniz. sagomata sfera PTFE	Ball seat PTFE	6	10	2,06
740 R 0091016	O-Ring perno EPDM Perox	Shaft O-Ring EPDM	7	10	0,80
740 R 0266026	O-Ring corpo EPDM Perox	Body O-Ring EPDM	8	10	1,09
22805 R 0118	Guarniz. ammortizzatrice EPDM Per	Seat O-Ring EPDM	9	10	1,30
740 R 0202035	O-Ring manicotto FPM	Union O-Ring EPDM	10	10	1,80
22805 R 0129	Kit guarniz. EPDM Perox	O-Ring kit EPDM	7-8-9-10	1	9,24
714 R 0091016	O-Ring perno FPM	Shaft O-Ring FPM	7+8+9+10	10	1,16
714 R 0266026	O-Ring corpo FPM	Body O-Ring FPM	8	10	2,25
02486 R 0118	Guarniz. ammortizzatrice FPM	Seat O-Ring FPM	9	10	1,73
714 R 0202035	O-Ring manicotto FPM	Union O-Ring FPM	10	10	4,32
22825 R 0129	Kit guarniz. FPM	O-Ring kit FPM	7-8-9-10	1	16,63
18435 R 0108	Chiave di regolazioni	Adjusting tool	7+8+9+10	5	4,06

D32 - 1" (PN 16)					
CODE	DESCRIZIONE	DESCRIPTION	Fig.	Q	EUR
22807 R 0121	Perno + O-Ring EPDM Perox	Shaft + EPDM O-Rings	1-7	5	3,50
22807 R 0102	Sfera	Ball	2	5	10,26
22807 R 0104	Ghiera	Union nut	3	10	6,30
22807 R 0124	Kit maniglia	Handle assembly	4	5	3,04
22807 R 0105	Manicotto D32	32 mm connection	5	10	5,67
22817 R 0105	Manicotto 1" BSP	1" connection BSF	5	10	8,51
02472 R 0115	Guarniz. sagomata sfera PTFE	Ball seat PTFE	6	10	3,39
740 R 0120025	O-Ring perno EPDM Perox	Shaft O-Ring EPDM	7	10	0,80
740 R 0378026	O-Ring corpo EPDM Perox	Body O-Ring EPDM	8	10	1,30
22807 R 0118	Guarniz. ammortizzatrice EPDM Per	Seat O-Ring EPDM	9	10	1,62
740 R 0329035	O-Ring manicotto EPDM Perox	Union O-Ring EPDM	10	10	3,29
22807 R 0129	Kit guarniz. EPDM Perox	O-Ring kit EPDM	7-8-9-10	1	10,47
714 R 0120025	O-Ring perno FPM	Shaft O-Ring FPM	7	10	1,70
714 R 0378026	O-Ring corpo FPM	Body O-Ring FPM	8	10	3,11
02488 R 0118	Guarniz. ammortizzatrice FPM	Seat O-Ring FPM	7+8+9+10	10	3,50
714 R 0329035	O-Ring manicotto FPM	Union O-Ring FPM	10	10	5,15
02488 R 0129	Kit guarniz. FPM	O-Ring kit FPM	7-8-9-10	1	22,48
18437 R 0108	Chiave di regolazioni	Adjusting tool	11	5	4,24

D50 - 1 1/2" (PN 16)					
CODE	DESCRIZIONE	DESCRIPTION	Fig.	Q	EUR
22809 R 0121	Perno + O-Ring EPDM Perox	Shaft + EPDM O-Rings	1-7	4	5,22
22809 R 0102	Sfera	Ball	2	4	19,47
22809 R 0104	Ghiera	Union nut	3	8	16,45
22809 R 0124	Kit maniglia	Handle assembly	1+7	4	4,20
22809 R 0105	Manicotto D50	50 mm connection	5	8	10,50
22819 R 0105	Manicotto 1 1/2" BSP	1 1/2" connection BSF	5	8	14,75
02474 R 0115	Guarniz. sagomata sfera PTFE	Ball seat PTFE	6	8	6,94
740 R 0155026	O-Ring perno EPDM Perox	Shaft O-Ring EPDM	7	10	0,80
740 R 0619035	O-Ring corpo EPDM Perox	Body O-Ring EPDM	8	5	2,76
22809 R 0118	Guarniz. ammortizzatrice EPDM Per	Seat O-Ring EPDM	9	8	2,27
740 R 0470053	O-Ring manicotto EPDM Perox	Union O-Ring EPDM	10	5	5,35
22809 R 0129	Kit guarniz. EPDM Perox	O-Ring kit EPDM	7-8-9-10	1	13,62
714 R 0155026	O-Ring perno FPM	Shaft O-Ring FPM	7	10	2,25
714 R 0619035	O-Ring corpo FPM	Body O-Ring FPM	8	5	2,16
02490 R 0118	Guarniz. ammortizzatrice FPM	Seat O-Ring FPM	7+8+9+10	8	5,10
714 R 0470053	O-Ring manicotto FPM	Union O-Ring FPM	10	10	14,82
02490 R 0129	Kit guarniz. FPM	O-Ring kit FPM	7-8-9-10	1	43,22
18439 R 0108	Chiave di regolazioni	Adjusting tool	11	4	5,33

D75 - 2 1/2" (PN 10)					
CODE	DESCRIZIONE	DESCRIPTION	Fig.	Q	EUR
22811 R 0121	Perno + O-Ring EPDM Perox	Shaft + EPDM O-Rings	1-7	2	19,12
22811 R 0102	Sfera	Ball	2	2	56,05
22811 R 0104	Ghiera	Union nut	3	4	44,84
22811 R 0124	Kit maniglia	Handle assembly	4	2	12,53
22811 R 0105	Manicotto D75	75 mm connection	1+7	4	25,55
22821 R 0105	Manicotto 2 1/2" BSP	2 1/2" connection BSF	5	4	46,78
02476 R 0115	Guarniz. sagomata sfera PTFE	Ball seat PTFE	6	4	12,88
740 R 0234035	O-Ring perno EPDM Perox	Shaft O-Ring EPDM	7	10	1,30
740 R 0978053	O-Ring corpo EPDM Perox	Body O-Ring EPDM	8	2	6,78
22811 R 0118	Guarniz. ammortizzatrice EPDM Per	Seat O-Ring EPDM	9	4	3,78
740 R 0756053	O-Ring manicotto EPDM Perox	Union O-Ring EPDM	10	5	7,80
22811 R 0129	Kit guarniz. EPDM Perox	O-Ring kit EPDM	7-8-9-10	1	21,91
714 R 0234035	O-Ring perno FPM	Shaft O-Ring FPM	7	10	3,40
714 R 0978053	O-Ring corpo FPM	Body O-Ring FPM	8	2	25,11
02492 R 0118	Guarniz. ammortizzatrice FPM	Seat O-Ring FPM	9	4	10,00
714 R 0756053	O-Ring manicotto FPM	Union O-Ring FPM	10	5	26,32
02492 R 0129	Kit guarniz. FPM	O-Ring kit FPM	7+8+9+10	1	77,27
18441 R 0108	Chiave di regolazioni	Adjusting tool	11	2	6,22

D110 - 4" (PN 10)					
CODE	DESCRIZIONE	DESCRIPTION	Fig.	Q	EUR
26444 R 0121	Perno + O-Ring EPDM Perox	Shaft + EPDM O-Rings	7+8+9+10	1	38,43
26444 R 0102	Sfera	Ball	2	1	222,81
26444 R 0104	Ghiera valvola D110	Union nut 110 mm	3	2	156,35
26444 R 0124	Kit maniglia	Handle assembly	4	1	16,37
26444 R 0105	Manicotto D110	110 mm connection	5	2	86,92
26445 R 0105	Manicotto 4" BSP	4" connection BSF	5	2	123,08
22065 R 0115	Guarniz. sagomata sfera PTFE	Ball seat PTFE	1+7	2	51,49
740 R 0266035	O-Ring perno EPDM Perox	Shaft O-Ring EPDM	7	10	1,30
740 R 1600040	O-Ring corpo EPDM Perox	Body O-Ring EPDM	8	1	9,44
26444 R 0118	Guarniz. ammortizzatrice EPDM Per	Seat O-Ring EPDM	9	2	5,74
740 R 1092057	O-Ring manicotto EPDM Perox	Union O-Ring EPDM	10	2	12,96
26444 R 0129	Kit guarniz. EPDM Perox	O-Ring kit EPDM	7-8-9-10	1	29,73
714 R 0266035	O-Ring perno FPM	Shaft O-Ring FPM	7	10	3,61
714 R 1600040	O-Ring corpo FPM	Body O-Ring FPM	8	1	21,63
22801 R 0118	Guarniz. ammortizzatrice FPM	Seat O-Ring FPM	9	2	35,73
714 R 1092057	O-Ring manicotto FPM	Union O-Ring FPM	10	2	30,62
22801 R 0129	Kit guarniz. FPM	O-Ring kit FPM	7-8-9-10	1	115,30
22799 R 0108	Chiave di regolazioni	Adjusting tool	7+8+9+10	2	36,34

D25 - 3/4" (PN 16)					
CODE	DESCRIZIONE	DESCRIPTION	Fig.	Q	EUR
22806 R 0121	Perno + O-Ring EPDM Perox	Shaft + EPDM O-Rings	1+7	5	3,29
22806 R 0102	Sfera	Ball	2	5	8,20
22806 R 0104	Ghiera	Union nut	3	10	5,02
22806 R 0124	Kit maniglia	Handle assembly	4	5	2,21
22806 R 0105	Manicotto D25	25 mm connection	5	10	4,17
22816 R 0105	Manicotto 3/4" BSP	3/4" connection BSP	5	10	6,69
02471 R 0115	Guarniz. sagomata sfera PTFE	Ball seat PTFE	6	10	3,02
740 R 0111018	O-Ring perno EPDM Perox	Shaft O-Ring EPDM	7	10	0,80
740 R 0330026	O-Ring corpo EPDM Perox	Body O-Ring EPDM	8	10	1,30
22806 R 0118	Guarniz. ammortizzatrice EPDM Per	Seat O-Ring EPDM	9	10	1,62
740 R 0282035	O-Ring manicotto EPDM Perox	Union O-Ring EPDM	10	10	2,31
22806 R 0129	Kit guarniz. EPDM Perox	O-Ring kit EPDM	7-8-9-10	1	9,67
714 R 0111018	O-Ring perno FPM	Shaft O-Ring FPM	7+8+9+10	10	1,30
714 R 0330026	O-Ring corpo FPM	Body O-Ring FPM	8	10	3,39
02487 R 0118	Guarniz. ammortizzatrice FPM	Seat O-Ring FPM	9	10	2,74
714 R 0282035	O-Ring manicotto FPM	Union O-Ring FPM	10	10	4,84
02487 R 0129	Kit guarniz. FPM	O-Ring kit FPM	7-8-9-10	1	18,52
18435 R 0108	Chiave di regolazioni	Adjusting tool	7+8+9+10	1	4,06

D40 - 1 1/4" (PN 16)					
CODE	DESCRIZIONE	DESCRIPTION	Fig.	Q	EUR
22808 R 0121	Perno + O-Ring EPDM Perox	Shaft + EPDM O-Rings	1-7	5	3,78
22808 R 0102	Sfera	Ball	2	5	13,01
22808 R 0104	Ghiera	Union nut	3	10	9,16
22808 R 0124	Kit maniglia	Handle assembly	4	5	3,21
22808 R 0105	Manicotto D40	40 mm connection	5	10	7,71
22818 R 0105	Manicotto 1 1/4" BSP	1 1/4" connection BSF	5	10	10,15
02473 R 0115	Guarniz. sagomata sfera PTFE	Ball seat PTFE	6	10	6,18
740 R 0139026	O-Ring perno EPDM Perox	Shaft O-Ring EPDM	7	10	1,09
740 R 0300026	O-Ring corpo EPDM Perox	Body O-Ring EPDM	8	5	2,27
22808 R 0118	Guarniz. ammortizzatrice EPDM Per	Seat O-Ring EPDM	9	10	2,08
740 R 0407053	O-Ring manicotto EPDM Perox	Union O-Ring EPDM	10	10	4,77
22808 R 0129	Kit guarniz. EPDM Perox	O-Ring kit EPDM	7-8-9-10	1	13,30
714 R 0139026	O-Ring perno FPM	Shaft O-Ring FPM	7	10	2,25
714 R 0505026	O-Ring corpo FPM	Body O-Ring FPM	8	5	6,65
02489 R 0118	Guarniz. ammortizzatrice FPM	Seat O-Ring FPM	7+8+9+10	10	4,33
714 R 0407053	O-Ring manicotto FPM	Union O-Ring FPM	10	10	10,52
02489 R 0129	Kit guarniz. FPM	O-Ring kit FPM	7-8-9-10	1	34,57
18437 R 0108	Chiave di regolazioni	Adjusting tool	11	1	4,24

D63 - 2" (PN 16)					
CODE	DESCRIZIONE	DESCRIPTION	Fig.	Q	EUR
22810 R 0121	Perno + O-Ring EPDM Perox	Shaft + EPDM O-Rings	1-7	4	5,22
22810 R 0102	Sfera	Ball	2	4	28,82
22810 R 0104	Ghiera	Union nut	3	8	23,18
22810 R 0124	Kit maniglia	Handle assembly	1+7	4	6,10
22810 R 0105	Manicotto D63	63 mm connection	5	8	16,45
22820 R 0105	Manicotto 2" BSP	2" connection BSF	5	8	22,48
22810 R 0115	Guarniz. sagomata sfera PTFE	Ball seat PTFE	6	8	9,44
740 R 0155026	O-Ring perno EPDM Perox	Shaft O-Ring EPDM	7	10	0,80
740 R 0756053	O-Ring corpo EPDM Perox	Body O-Ring EPDM	8	5	3,08
22810 R 0118	Guarniz. ammortizzatrice EPDM Per	Seat O-Ring EPDM	9	8	2,44
740 R 0597053	O-Ring manicotto EPDM Perox	Union O-Ring EPDM	10	5	5,39
22810 R 0129	Kit guarniz. EPDM Perox	O-Ring kit EPDM	7-8-9-10	1	15,87
714 R 0155026	O-Ring perno FPM	Shaft O-Ring FPM	7	10	2,25
714 R 0756053	O-Ring corpo FPM	Body O-Ring FPM	8	5	10,72
02491 R 0118	Guarniz. ammortizzatrice FPM	Seat O-Ring FPM	7+8+9+10	8	8,95
714 R 0597053	O-Ring manicotto FPM	Union O-Ring FPM	7+8+9+10	5	15,16
02491 R 0129	Kit guarniz. FPM	O-Ring kit FPM	7-8-9-10	1	57,20
18439 R 0108	Chiave di regolazioni	Adjusting tool	11	4	5,33

D90 - 3"					
CODE	DESCRIZIONE	DESCRIPTION	Fig.	Q	EUR
22812 R 0121	Perno + O-Ring EPDM Perox	Shaft + EPDM O-Rings	7		

VALVOLE A SFERA IN PVC-U SERIE 3 VIE - PVC-U BALL VALVES 3-WAY SERIES

C01 | 007 900

D50 - 1 1/2"					
CODE	DESCRIZIONE	DESCRIPTION	Fig.	Q	EUR
02457 R 0121	Perno + O-Ring EPDM	Shaft + EPDM O-Rings	1+9	4	2,11
20168 R 0102	Sfera	Ball	2	4	9,03
02457 R 0104	Ghiera normale	Union nut	3	8	5,87
20169 R 0104	Ghiera orientabile	Self-align union nut	4	4	8,08
20168 R 0124	Kit maniglia	Handle assembly	12+13	4	19,70
20168 R 0105	Manicotto D50	50 mm connection	4	1	10,18
20170 R 0105	Manicotto 1 1/2" BSP	1 1/2" connection BSP	5	8	12,90
20169 R 0105	Manicotto D50 orientabile	50 mm self-align connection	6	4	4,70
20169 R 0108	Rotante	Ball-socket joint	7	4	3,40
723 R 0550060	Guarnizione per rotante	Ball-socket joint O-Ring	8	5	1,61
20168 R 0107	Guarniz. sagomata sfera HDPE	Ball seat HDPE	10	16	1,31
723 R 0155026	O-Ring perno EPDM	Shaft O-Ring EPDM	9	10	0,45
723 R 0599035	O-Ring corpo EPDM	Body O-Ring EPDM	15	5	1,23
20168 R 0118	Guarniz. ammortizzatrice EPDM	Seat O-Ring EPDM	11	16	0,95
723 R 0597053	O-Ring manicotto EPDM	Union O-Ring EPDM	14	5	2,05
20168 R 0129	Kit guarniz. EPDM (eccetto rotante)	O-Ring kit EPDM (except ball-socket joint)	9+11+14+15	1	12,78

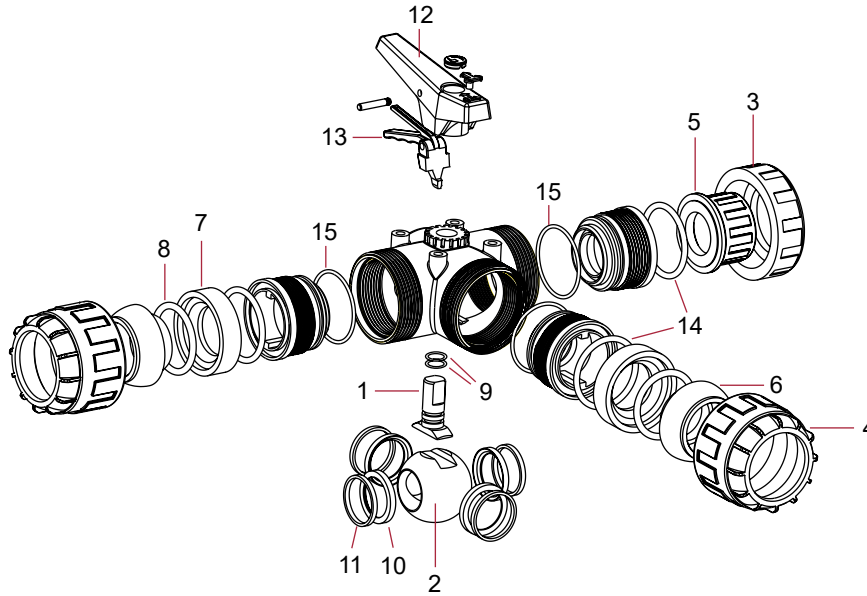

VALVOLE A GHIGLIOTTINA IN PVC-U - PVC-U KNIFE GATE VALVES

C01 | 007 900

GUILLOTINA - KNIFE GATE					
CODE	DESCRIZIONE	DESCRIPTION	Fig.	Q	EUR
28590 R 0124	Kit maniglia + clip	Handle assembly + clip	1+3	1	5,44
43578 R 0124	Kit maniglia + clip D90-110	Handle assembly + clip D90-110	1+3	1	9,26
28590 R 0110	Guarnizione EPDM - D50	EPDM gasket - D50	2	2	3,19
28600 R 0110	Guarnizione EPDM - D63	EPDM gasket - D63	2	2	4,05
43578 R 0110	Guarnizione EPDM - D90-110	EPDM gasket - D90-110	2	2	20,11

**VALVOLE A GHIGLIOTTINA IN PVC-U
D50-D63**

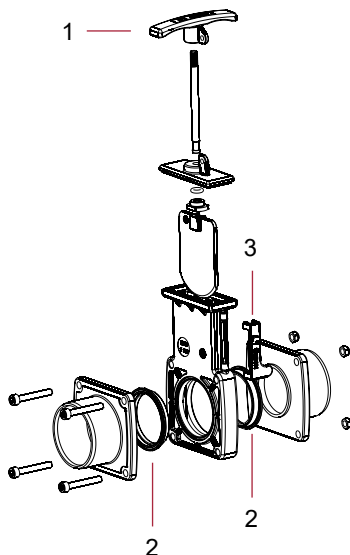

**VALVOLE A GHIGLIOTTINA IN PVC-U
D90-D110**

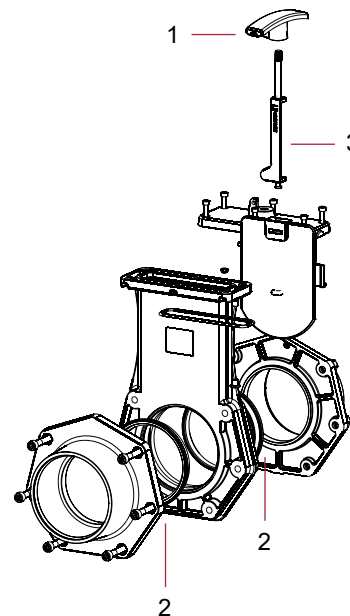

Accessori PVC-U
Valvole PVC-U
Accessori PVC-C
Valvole PVC-C
Valvole Extreme
Evacuazione
Ricambi

VALVOLE DI RITEGNO E DI FONDO IN PVC-U SERIE MOLLA - PVC-U CHECK VALVES SPRING SERIES

C01 | 007 900

D16 - 3/4" / D20 - 1/2"					
CODE	DESCRIZIONE	DESCRIPTION	Fig.	Q	EUR
02543 R 0106	Rete	Screen	3	5	2,74
02543 R 0104	Ghiera	Union nut	4	10	1,74
05352 R 0105	Manicotto D16	16 mm connection	5	10	1,24
02453 R 0105	Manicotto D20	20 mm connection	5	10	1,24
05353 R 0105	Manicotto 3/4" BSP	3/4" connection BSP	5	10	1,82
02462 R 0105	Manicotto 1/2" BSP	1/2" connection BSP	5	10	1,82
723 R 0139035	O-Ring cono EPDM	Cone O-Ring EPDM	6	10	0,66
723 R 0266026	O-Ring corpo EPDM	Body O-Ring EPDM	7	10	0,66
723 R 0202035	O-Ring manicotto EPDM	Union O-Ring EPDM	8	10	0,76
08991 R 0121	Cono + O-Ring EPDM	Cone + O-Ring EPDM	1+6	5	3,57
08991 R 0110	Molla	Spring	2	5	2,86
08991 R 0129	Kit guarniz. EPDM	O-Ring kit EPDM	6+7+8	1	3,11
714 R 0139035	O-Ring cono FPM	Cone O-Ring FPM	6	10	2,07
714 R 0266026	O-Ring corpo FPM	Body O-Ring FPM	7	10	2,25
714 R 0202035	O-Ring manicotto FPM	Union O-Ring FPM	1+6	10	4,32
18732 R 0121	Cono + O-Ring FPM	Cone + O-Ring FPM	1+6	5	4,90
08991 R 0130	Kit guarniz. FPM	O-Ring kit FPM	6+7+8	1	11,09

D32 - 1"					
CODE	DESCRIZIONE	DESCRIPTION	Fig.	Q	EUR
02545 R 0106	Rete	Screen	3	5	3,82
02455 R 0104	Ghiera	Union nut	4	10	2,74
02455 R 0105	Manicotto D32	32 mm connection	5	10	1,99
02464 R 0105	Manicotto 1" BSP	1" connection BSP	5	10	2,74
723 R 0250035	O-Ring cono EPDM	Cone O-Ring EPDM	6	10	0,66
723 R 0378026	O-Ring corpo EPDM	Body O-Ring EPDM	7	10	0,66
723 R 0329035	O-Ring manicotto EPDM	Union O-Ring EPDM	8	10	1,14
08993 R 0121	Cono + O-Ring EPDM	Cone + O-Ring EPDM	1+6	5	4,76
08993 R 0110	Molla	Spring	2	5	3,61
08993 R 0129	Kit guarniz. EPDM	O-Ring kit EPDM	6+7+8	1	3,40
714 R 0250035	O-ring cono FPM	Cone O-Ring FPM	6	10	3,15
714 R 0378026	O-Ring corpo FPM	Body O-Ring FPM	7	10	3,11
714 R 0329035	O-Ring manicotto FPM	Union O-Ring FPM	1+6	10	5,15
18734 R 0121	Cono + O-Ring FPM	Cone + O-Ring FPM	1+6	5	6,90
08993 R 0130	Kit guarniz. FPM	O-Ring kit FPM	6+7+8	1	17,85

D50 - 1 1/2"					
CODE	DESCRIZIONE	DESCRIPTION	Fig.	Q	EUR
02547 R 0106	Rete	Screen	3	4	6,80
02502 R 0104	Ghiera	Union nut	4	8	4,37
02502 R 0105	Manicotto D50	50 mm connection	5	8	3,67
02504 R 0105	Manicotto 1 1/2" BSP	1 1/2" connection BSP	5	8	6,79
723 R 0387035	O-ring cono EPDM	Cone O-Ring EPDM	6	10	0,46
723 R 0567035	O-Ring corpo EPDM	Body O-Ring EPDM	7	5	1,08
723 R 0470053	O-Ring manicotto EPDM	Union O-Ring EPDM	8	10	1,82
08995 R 0121	Cono + O-Ring EPDM	Cone + O-Ring EPDM	1+6	4	5,99
08995 R 0110	Molla	Spring	2	4	5,99
08995 R 0129	Kit guarniz. EPDM	O-Ring kit EPDM	6+7+8	1	4,48
714 R 0387035	O-ring cono FPM	Cone O-Ring FPM	6	10	3,10
714 R 0567035	O-Ring corpo FPM	Body O-Ring FPM	1+6	5	12,12
714 R 0470053	O-Ring manicotto FPM	Union O-Ring FPM	8	10	14,82
18736 R 0121	Cono + O-Ring FPM	Cone + O-Ring FPM	1+6	4	8,05
08995 R 0130	Kit guarniz. FPM	O-Ring kit FPM	6+7+8	1	33,17

D75 - 2 1/2"					
CODE	DESCRIZIONE	DESCRIPTION	Fig.	Q	EUR
02549 R 0106	Rete	Screen	3	2	9,89
02459 R 0104	Ghiera	Union nut	4	4	17,99
02459 R 0105	Manicotto D75	75 mm connection	5	4	8,08
02468 R 0105	Manicotto 2 1/2" BSP	2 1/2" connection BSP	5	4	14,51
723 R 0660053	O-ring cono EPDM	Cone O-Ring EPDM	6	5	1,83
723 R 0978053	O-Ring corpo EPDM	Body O-Ring EPDM	7	2	2,74
723 R 0756053	O-Ring manicotto EPDM	Union O-Ring EPDM	8	5	4,90
08997 R 0121	Cono + O-Ring EPDM	Cone + O-Ring EPDM	1+6	2	13,65
08997 R 0110	Molla	Spring	2	2	12,40
08997 R 0129	Kit guarniz. EPDM	O-Ring kit EPDM	6+7+8	1	7,62
714 R 0660053	O-ring cono FPM	Cone O-Ring FPM	1+6	5	8,79
714 R 0978053	O-Ring corpo FPM	Body O-Ring FPM	7	2	25,11
714 R 0756053	O-Ring manicotto FPM	Union O-Ring FPM	8	5	26,32
18738 R 0121	Cono + O-Ring FPM	Cone + O-Ring FPM	1+6	2	18,19
08997 R 0130	Kit guarniz. FPM	O-Ring kit FPM	6+7+8	1	80,36

D25 - 3/4"					
CODE	DESCRIZIONE	DESCRIPTION	Fig.	Q	EUR
02544 R 0106	Rete	Screen	3	5	3,35
02454 R 0104	Ghiera	Union nut	4	10	2,38
02454 R 0105	Manicotto D25	25 mm connection	5	10	1,38
02463 R 0105	Manicotto 3/4" BSP	3/4" connection BSP	5	10	2,11
723 R 0202035	O-ring cono EPDM	Cone O-Ring EPDM	6	10	0,76
723 R 0330026	O-Ring corpo EPDM	Body O-Ring EPDM	7	10	0,66
723 R 0282035	O-Ring manicotto EPDM	Union O-Ring EPDM	8	10	0,94
08992 R 0121	Cono + O-Ring EPDM	Cone + O-Ring EPDM	1+6	5	3,89
08992 R 0110	Molla	Spring	2	5	3,02
08992 R 0129	Kit guarniz. EPDM	O-Ring kit EPDM	6+7+8	1	3,34
714 R 0202035	O-ring cono FPM	Cone O-Ring FPM	6	10	4,32
714 R 0330026	O-Ring corpo FPM	Body O-Ring FPM	7	10	3,39
714 R 0282035	O-Ring manicotto FPM	Union O-Ring FPM	1+6	10	4,84
18733 R 0121	Cono + O-Ring FPM	Cone + O-Ring FPM	1+6	5	5,69
08992 R 0130	Kit guarniz. FPM	O-Ring kit FPM	6+7+8	1	14,22

D40 - 1 1/4"					
CODE	DESCRIZIONE	DESCRIPTION	Fig.	Q	EUR
02546 R 0106	Rete	Screen	3	5	4,51
02456 R 0104	Ghiera	Union nut	4	10	3,78
02456 R 0105	Manicotto D40	40 mm connection	5	10	2,43
02465 R 0105	Manicotto 1 1/4" BSP	1 1/4" connection BSP	5	10	3,16
723 R 0329035	O-ring cono EPDM	Cone O-Ring EPDM	6	10	1,14
723 R 0505026	O-Ring corpo EPDM	Body O-Ring EPDM	7	5	0,95
723 R 0407053	O-Ring manicotto EPDM	Union O-Ring EPDM	8	10	1,35
08994 R 0121	Cono + O-Ring EPDM	Cone + O-Ring EPDM	1+6	5	5,19
08994 R 0110	Molla	Spring	2	5	5,19
08994 R 0129	Kit guarniz. EPDM	O-Ring kit EPDM	6+7+8	1	4,48
714 R 0329035	O-ring cono FPM	Cone O-Ring FPM	6	10	5,15
714 R 0505026	O-Ring corpo FPM	Body O-Ring FPM	7	5	5,65
714 R 0407053	O-Ring manicotto FPM	Union O-Ring FPM	1+6	10	10,52
18735 R 0121	Cono + O-Ring FPM	Cone + O-Ring FPM	1+6	5	8,54
08994 R 0130	Kit guarniz. FPM	O-Ring kit FPM	6+7+8	1	17,62

D63 - 2"					
CODE	DESCRIZIONE	DESCRIPTION	Fig.	Q	EUR
02548 R 0106	Rete	Screen	3	4	8,08
02503 R 0104	Ghiera	Union nut	4	8	7,04
02503 R 0105	Manicotto D63	63 mm connection	5	8	4,50
02505 R 0105	Manicotto 2"	2" connection BSP	5	8	6,47
723 R 0504035	O-ring cono EPDM	Cone O-Ring EPDM	6	5	0,95
723 R 0694035	O-Ring corpo EPDM	Body O-Ring EPDM	7	5	1,30
723 R 0597053	O-Ring manicotto EPDM	Union O-Ring EPDM	8	5	2,05
08996 R 0121	Cono + O-Ring EPDM	Cone + O-Ring EPDM	1+6	4	6,72
08996 R 0110	Molla	Spring	2	4	8,72
08996 R 0129	Kit guarniz. EPDM	O-Ring kit EPDM	6+7+8	1	5,33
714 R 0504035	O-ring cono FPM	Cone O-Ring FPM	6	5	5,36
714 R 0694035	O-Ring corpo FPM	Body O-Ring FPM	1+6	5	12,76
714 R 0597053	O-Ring manicotto FPM	Union O-Ring FPM	8	5	15,16
18737 R 0121	Cono + O-Ring FPM	Cone + O-Ring FPM	1+6	4	11,25
08996 R 0130	Kit guarniz. FPM	O-Ring kit FPM	6+7+8	1	43,67

D90 - 3" / D110 - 4" (DN80)					
CODE	DESCRIZIONE	DESCRIPTION	Fig.	Q	EUR
02550 R 0106	Rete	Screen	3	1	12,43
02460 R 0104	Ghiera válvula D90	Union nut 90 mm	4	2	25,23
02461 R 0104	Ghiera válvula D110	Union nut 110 mm	4	2	27,13
02460 R 0105	Manicotto D90	90 mm connection	5	2	13,41
02461 R 0105	Manicotto D110	110 mm connection	5	2	21,16
02469 R 0105	Manicotto 3"	3" connection BSP	5	2	19,59
05354 R 0105	Manicotto 4"	4" connection BSP	5	2	25,97
723 R 0840053	O-ring cono EPDM	Cone O-Ring EPDM	6	5	2,16
723 R 1238053	O-Ring corpo EPDM	Body O-Ring EPDM	7	1	5,33
723 R 0914053	O-Ring manicotto EPDM	Union O-Ring EPDM	8	2	6,40
08998 R 0121	Cono + O-Ring EPDM	Cone + O-Ring EPDM	1+6	1	15,81
08998 R 0110	Molla	Spring	2	1	16,49
08998 R 0129	Kit guarniz. EPDM	O-Ring kit EPDM	6+7+8	1	10,00
714 R 0840053	O-ring cono FPM	Cone O-Ring FPM	1+6	5	13,83
714 R 1238053	O-Ring corpo FPM	Body O-Ring FPM	7	1	33,00
714 R 0914053	O-Ring manicotto FPM	Union O-Ring FPM	8	2	27,67
18739 R 0121	Cono + O-Ring FPM	Cone + O-Ring FPM	1+6	1	25,79
08998 R 0130	Kit guarniz. FPM	O-Ring kit FPM	6+7+8	1	95,70

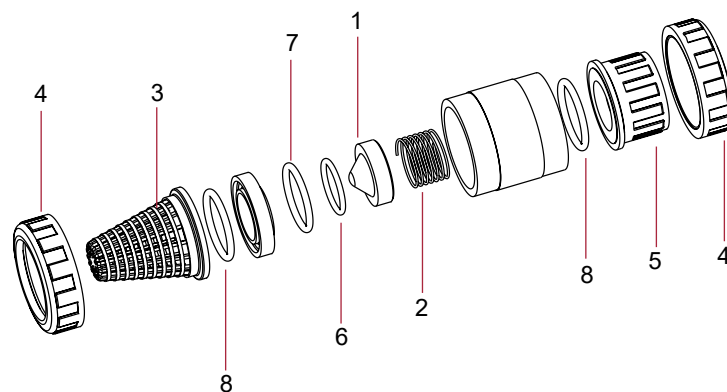

Accessori PVC-U

Valvole PVC-U

Accessori PVC-C

Valvole PVC-C

Valvole Extreme

Evacuazione

Ricambi

VALVOLE DI RITEGNO E DI FONDO IN PVC-U SERIE SFERA - PVC-U CHECK VALVES BALL SERIES

C01 | 007 900

D16 - 3/8" / D20 - 1/2"					
CODE	DESCRIZIONE	DESCRIPTION	Fig.	Q	EUR
22078 R 0102	Sfera	Ball	1	1	20,40
02543 R 0106	Rete	Screen	3	5	2,74
02543 R 0104	Ghiera	Union nut	4	10	1,74
05352 R 0105	Manicotto D16	16 mm connection	5	10	1,24
02453 R 0105	Manicotto D20	20 mm connection	5	10	1,24
05353 R 0105	Manicotto 3/8" BSP	3/8" connection BSP	5	10	1,82
02462 R 0105	Manicotto 1/2" BSP	1/2" connection BSP	5	10	1,82
22078 R 0107	O-Ring EPDM	O-Ring EPDM	2	5	2,21
22090 R 0107	O-Ring FPM	O-Ring FPM	2	5	5,39
723 R 0202035	O-Ring manicotto EPDM	Union O-Ring EPDM	8	10	0,76
714 R 0202035	O-Ring manicotto FPM	Union O-Ring FPM	8	10	4,32

D32 - 1"					
CODE	DESCRIZIONE	DESCRIPTION	Fig.	Q	EUR
22080 R 0102	Sfera	Ball	1	1	23,81
02545 R 0106	Rete	Screen	3	5	3,82
02455 R 0104	Ghiera	Union nut	4	10	2,74
02455 R 0105	Manicotto D32	32 mm connection	5	10	1,99
02464 R 0105	Manicotto 1" BSP	1" connection BSP	5	10	2,74
22080 R 0107	O-Ring EPDM	O-Ring EPDM	2	5	3,59
22092 R 0107	O-Ring FPM	O-Ring FPM	2	5	8,94
723 R 0329035	O-Ring manicotto EPDM	Union O-Ring EPDM	8	10	1,14
714 R 0329035	O-Ring manicotto FPM	Union O-Ring FPM	8	10	5,15

D50 - 1 1/2"					
CODE	DESCRIZIONE	DESCRIPTION	Fig.	Q	EUR
25697 R 0102	Sfera	Ball	1	1	34,26
02547 R 0106	Rete	Screen	3	4	6,80
02502 R 0104	Ghiera	Union nut	4	8	4,37
02457 R 0105	Manicotto D50	50 mm connection	5	8	3,42
02466 R 0105	Manicotto 1 1/2" BSP	1 1/2" connection BSP	5	8	4,48
25697 R 0107	O-Ring EPDM	O-Ring EPDM	2	4	7,10
25701 R 0107	O-Ring FPM	O-Ring FPM	2	4	18,60
723 R 0470053	O-Ring manicotto EPDM	Union O-Ring EPDM	8	10	1,82
714 R 0470053	O-Ring manicotto FPM	Union O-Ring FPM	8	10	14,82

D75 - 2 1/2"					
CODE	DESCRIZIONE	DESCRIPTION	Fig.	Q	EUR
22175 R 0102	Sfera	Ball	1	1	83,28
02549 R 0106	Rete	Screen	3	2	9,89
02459 R 0104	Ghiera	Union nut	4	4	17,99
02459 R 0105	Manicotto D75	75 mm connection	5	4	8,08
02468 R 0105	Manicotto 2 1/2" BSP	2 1/2" connection BSP	5	4	14,51
22175 R 0107	O-Ring EPDM	O-Ring EPDM	2	2	11,19
22240 R 0107	O-Ring FPM	O-Ring FPM	2	2	50,35
723 R 0756053	O-Ring manicotto EPDM	Union O-Ring EPDM	8	5	4,90
714 R 0756053	O-Ring manicotto FPM	Union O-Ring FPM	8	5	26,32

D25 - 3/4"					
CODE	DESCRIZIONE	DESCRIPTION	Fig.	Q	EUR
22079 R 0102	Sfera	Ball	1	1	22,04
02544 R 0106	Rete	Screen	3	5	3,35
02454 R 0104	Ghiera	Union nut	4	10	2,38
02454 R 0105	Manicotto D25	25 mm connection	5	10	1,38
02463 R 0105	Manicotto 3/4" BSP	3/4" connection BSP	5	10	2,11
22079 R 0107	O-Ring EPDM	O-Ring EPDM	2	5	2,69
22091 R 0107	O-Ring FPM	O-Ring FPM	2	5	7,44
723 R 0282035	O-Ring manicotto EPDM	Union O-Ring EPDM	8	10	0,94
714 R 0282035	O-Ring manicotto FPM	Union O-Ring FPM	8	10	4,84

D40 - 1 1/4"					
CODE	DESCRIZIONE	DESCRIPTION	Fig.	Q	EUR
22174 R 0102	Sfera	Ball	1	1	32,65
02546 R 0106	Rete	Screen	3	5	4,51
02456 R 0104	Ghiera	Union nut	4	10	3,78
02456 R 0105	Manicotto D40	40 mm connection	5	10	2,43
02465 R 0105	Manicotto 1 1/4" BSP	1 1/4" connection BSP	5	10	3,16
22174 R 0107	O-Ring EPDM	O-Ring EPDM	2	5	4,75
22239 R 0107	O-Ring FPM	O-Ring FPM	2	5	14,18
723 R 0407053	O-Ring manicotto EPDM	Union O-Ring EPDM	8	10	1,35
714 R 0407053	O-Ring manicotto FPM	Union O-Ring FPM	8	10	10,52

D63 - 2"					
CODE	DESCRIZIONE	DESCRIPTION	Fig.	Q	EUR
25698 R 0102	Sfera	Ball	1	1	37,08
02548 R 0106	Rete	Screen	3	4	8,08
02503 R 0104	Ghiera	Union nut	4	8	7,04
02503 R 0105	Manicotto D63	63 mm connection	5	8	4,50
02505 R 0105	Manicotto 2"	2" connection BSP	5	8	6,47
25698 R 0107	O-Ring EPDM	O-Ring EPDM	2	4	8,31
25702 R 0107	O-Ring FPM	O-Ring FPM	2	4	26,76
723 R 0597053	O-Ring manicotto EPDM	Union O-Ring EPDM	8	5	2,05
714 R 0597053	O-Ring manicotto FPM	Union O-Ring FPM	8	5	15,16

D90 - 3" / D110 - 4" (DN80)					
CODE	DESCRIZIONE	DESCRIPTION	Fig.	Q	EUR
22176 R 0102	Sfera	Ball	1	1	148,25
02550 R 0106	Rete	Screen	3	1	12,43
02460 R 0104	Ghiera válvula D90	Union nut 90 mm	4	2	25,23
02461 R 0104	Ghiera válvula D110	Union nut 110 mm	4	2	27,13
02460 R 0105	Manicotto D90	90 mm connection	5	2	13,41
02461 R 0105	Manicotto D110	110 mm connection	5	2	21,16
02469 R 0105	Manicotto 3"	3" connection BSP	5	2	19,59
05354 R 0105	Manicotto 4"	4" connection BSP	5	2	25,97
22176 R 0107	O-Ring EPDM	O-Ring EPDM	2	1	18,82
22241 R 0107	O-Ring FPM	O-Ring FPM	2	1	78,82
723 R 0914053	O-Ring manicotto EPDM	Union O-Ring EPDM	8	2	6,40
714 R 0914053	O-Ring manicotto FPM	Union O-Ring FPM	8	2	27,67

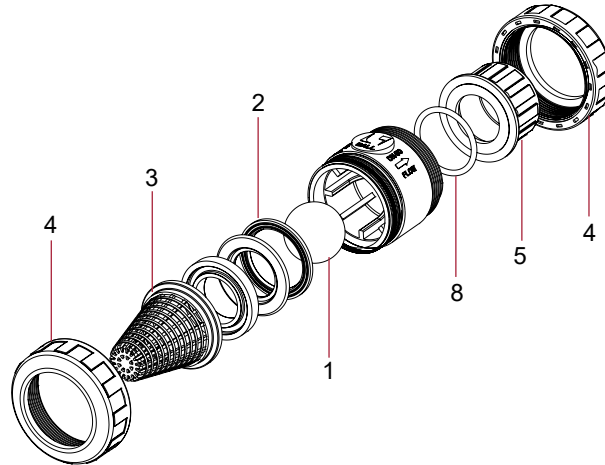

VALVOLE DI RITEGNO E DI FONDO IN PVC-C SERIE SFERA - PVC-C CHECK VALVES BALL SERIES

C01 | 007 900

D16 - 3/8" / D20 - 1/2"					
CODE	DESCRIZIONE	DESCRIPTION	Fig.	Q	EUR
27501 R 0102	Sfera	Ball	1	1	57,05
02543 R 0106	Rete	Screen	3	5	2,74
22805 R 0104	Ghiera	Union nut	4	10	3,36
22805 R 0105	Manicotto D20	20 mm connection	5	10	3,47
22815 R 0105	Manicotto 1/2" BSP	1/2" connection BSP	5	10	5,42
22078 R 0107	O-Ring EPDM	O-Ring EPDM	2	5	2,21
22090 R 0107	O-Ring FPM	O-Ring FPM	2	5	5,39
723 R 0202035	O-Ring manico EPDM	Union O-Ring EPDM	8	10	0,76
714 R 0202035	O-Ring manico FPM	Union O-Ring FPM	8	10	4,32

D25 - 3/4"					
CODE	DESCRIZIONE	DESCRIPTION	Fig.	Q	EUR
27502 R 0102	Sfera	Ball	1	1	71,98
02544 R 0106	Rete	Screen	3	5	3,35
22806 R 0104	Ghiera	Union nut	4	10	5,02
22806 R 0105	Manicotto D25	25 mm connection	5	10	4,17
22816 R 0105	Manicotto 3/4" BSP	3/4" connection BSP	5	10	6,69
22079 R 0107	O-Ring EPDM	O-Ring EPDM	2	5	2,69
22091 R 0107	O-Ring FPM	O-Ring FPM	2	5	7,44
723 R 0262035	O-Ring manico EPDM	Union O-Ring EPDM	8	10	0,94
714 R 0262035	O-Ring manico FPM	Union O-Ring FPM	8	10	4,84

D32 - 1"					
CODE	DESCRIZIONE	DESCRIPTION	Fig.	Q	EUR
27503 R 0102	Sfera	Ball	1	1	87,97
02545 R 0106	Rete	Screen	3	5	3,82
22807 R 0104	Ghiera	Union nut	4	10	6,30
22807 R 0105	Manicotto D32	32 mm connection	5	10	5,67
22817 R 0105	Manicotto 1" BSP	1" connection BSP	5	10	8,51
22080 R 0107	O-Ring EPDM	O-Ring EPDM	2	5	3,59
22092 R 0107	O-Ring FPM	O-Ring FPM	2	5	8,94
723 R 0329035	O-Ring manico EPDM	Union O-Ring EPDM	8	10	1,14
714 R 0329035	O-Ring manico FPM	Union O-Ring FPM	8	10	5,15

D40 - 1 1/4"					
CODE	DESCRIZIONE	DESCRIPTION	Fig.	Q	EUR
27504 R 0102	Sfera	Ball	1	1	100,94
02546 R 0106	Rete	Screen	3	5	4,51
22808 R 0104	Ghiera	Union nut	4	10	9,16
22808 R 0105	Manicotto D40	40 mm connection	5	10	7,71
22818 R 0105	Manicotto 1 1/4" BSP	1 1/4" connection BSP	5	10	10,15
22174 R 0107	O-Ring EPDM	O-Ring EPDM	2	5	4,75
22239 R 0107	O-Ring FPM	O-Ring FPM	2	5	14,18
723 R 0407053	O-Ring manico EPDM	Union O-Ring EPDM	8	10	1,35
714 R 0407053	O-Ring manico FPM	Union O-Ring FPM	8	10	10,52

D50 - 1 1/2"					
CODE	DESCRIZIONE	DESCRIPTION	Fig.	Q	EUR
27505 R 0102	Sfera	Ball	1	1	104,51
02547 R 0106	Rete	Screen	3	4	6,80
22849 R 0104	Ghiera	Union nut	4	8	12,45
22849 R 0105	Manicotto D50	50 mm connection	5	8	6,79
22859 R 0105	Manicotto 1 1/2" BSP	1 1/2" connection BSP	5	8	11,32
25697 R 0107	O-Ring EPDM	O-Ring EPDM	2	4	7,10
25701 R 0107	O-Ring FPM	O-Ring FPM	2	4	18,60
723 R 0470053	O-Ring manico EPDM	Union O-Ring EPDM	8	10	1,82
714 R 0470053	O-Ring manico FPM	Union O-Ring FPM	8	10	14,82

D63 - 2"					
CODE	DESCRIZIONE	DESCRIPTION	Fig.	Q	EUR
27506 R 0102	Sfera	Ball	1	1	157,54
02548 R 0106	Rete	Screen	3	4	8,08
22850 R 0104	Ghiera	Union nut	4	8	19,43
22850 R 0105	Manicotto D63	63 mm connection	5	8	13,47
22860 R 0105	Manicotto 2"	2" connection BSP	5	8	18,99
25698 R 0107	O-Ring EPDM	O-Ring EPDM	2	4	8,31
25702 R 0107	O-Ring FPM	O-Ring FPM	2	4	26,76
723 R 0597053	O-Ring manico EPDM	Union O-Ring EPDM	8	5	2,05
714 R 0597053	O-Ring manico FPM	Union O-Ring FPM	8	5	15,16

D75 - 2 1/2"					
CODE	DESCRIZIONE	DESCRIPTION	Fig.	Q	EUR
27507 R 0102	Sfera	Ball	1	1	566,56
02549 R 0106	Rete	Screen	3	2	9,89
22811 R 0104	Ghiera	Union nut	4	4	44,84
22811 R 0105	Manicotto D75	75 mm connection	5	4	25,55
22821 R 0105	Manicotto 2 1/2" BSP	2 1/2" connection BSP	5	4	46,78
22175 R 0107	O-Ring EPDM	O-Ring EPDM	2	2	11,19
22240 R 0107	O-Ring FPM	O-Ring FPM	2	2	50,35
723 R 0756053	O-Ring manico EPDM	Union O-Ring EPDM	8	5	4,90
714 R 0756053	O-Ring manico FPM	Union O-Ring FPM	8	5	26,32

D90 - 3" / D110 - 4"					
CODE	DESCRIZIONE	DESCRIPTION	Fig.	Q	EUR
27508 R 0102	Sfera	Ball	1	1	1.216,73
02550 R 0106	Rete	Screen	3	1	12,43
22812 R 0104	Ghiera	Union nut 90 mm	4	2	65,67
22853 R 0104	Ghiera	Union nut 110 mm	4	2	75,08
22812 R 0105	Manicotto D90	90 mm connection	5	2	43,03
22853 R 0105	Manicotto D110	110 mm connection	5	2	59,55
22822 R 0105	Manicotto 3"	3" connection BSP	5	2	75,63
22863 R 0105	Manicotto 4"	4" connection BSP	5	2	125,22
22176 R 0107	O-Ring EPDM	O-Ring EPDM	2	1	18,82
22241 R 0107	O-Ring FPM	O-Ring FPM	2	1	78,82
723 R 0914053	O-Ring manico EPDM	Union O-Ring EPDM	8	2	6,40
714 R 0914053	O-Ring manico FPM	Union O-Ring FPM	8	2	27,67

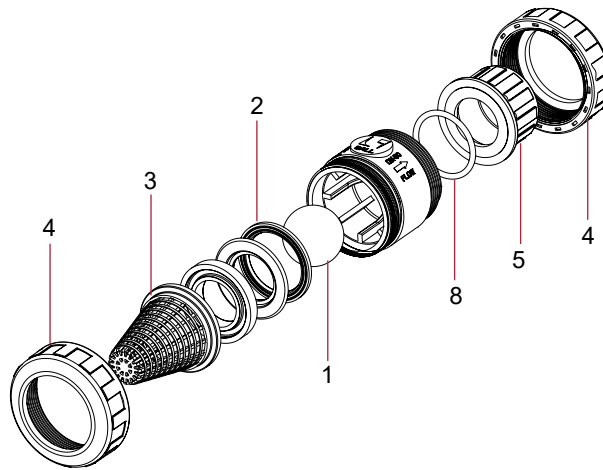

Accessori PVC-U
 Valvole PVC-U
 Accessori PVC-C
 Valvole PVC-C
 Valvole Extreme
 Evacuazione
 Ricambi

VALVOLE A CLAPET IN PVC-U - PVC-U SWING CHECK VALVES

C01 | 007 900

O-Ring corpo EPDM - BODY O-RING EPDM					
CODE	DESCRIZIONE	DESCRIPTION	Fig.	Q	EUR
37055 R 0400	O-Ring corpo EPDM D63	Body O-Ring EPDM D63	2	1	2,42
723 R 0914053	O-Ring corpo EPDM D75	Body O-Ring EPDM D75	2	2	6,40
723 R 1105053	O-Ring corpo EPDM D90	Body O-Ring EPDM D90	2	1	2,49
723 R 1359053	O-Ring corpo EPDM D110	Body O-Ring EPDM D110	2	1	2,80
723 R 1486053	O-Ring corpo EPDM D125	Body O-Ring EPDM D125	2	1	4,36
723 R 1600070	O-Ring corpo EPDM D90-D110	Body O-Ring EPDM D90-D110	2	1	6,10
723 R 1899070	O-Ring corpo EPDM D160	Body O-Ring EPDM D160	2	1	8,02
723 R 2216070	O-Ring corpo EPDM D200	Body O-Ring EPDM D200	2	1	8,46
723 R 2470070	O-Ring corpo EPDM D225	Body O-Ring EPDM D225	2	1	17,19
723 R 2530070	O-Ring corpo EPDM D250	Body O-Ring EPDM D250	2	1	9,72
37057 R 0400	O-Ring corpo EPDM D315	Body O-Ring EPDM D315	2	1	43,27

O-Ring clapet EPDM - FLAP O-RING EPDM					
CODE	DESCRIZIONE	DESCRIPTION	Fig.	Q	EUR
37055 R 0401	O-Ring clapet EPDM D63	Flap O-Ring EPDM D63	1	1	1,13
723 R 0407053	O-Ring clapet EPDM D75	Flap O-Ring EPDM D75	1	10	1,35
723 R 0565053	O-Ring clapet EPDM D90	Flap O-Ring EPDM D90	1	5	1,59
723 R 0724053	O-Ring clapet EPDM D110	Flap O-Ring EPDM D110	1	5	1,63
723 R 0819053	O-Ring clapet EPDM D125	Flap O-Ring EPDM D125	1	2	1,73
723 R 0914053	O-Ring clapet EPDM D140	Flap O-Ring EPDM D140	1	2	6,40
723 R 1137053	O-Ring clapet EPDM D160	Flap O-Ring EPDM D160	1	1	3,04
723 R 1359053	O-Ring clapet EPDM D200	Flap O-Ring EPDM D200	1	1	2,80
723 R 1486053	O-Ring clapet EPDM D225	Flap O-Ring EPDM D225	1	1	4,36
723 R 1645053	O-Ring clapet EPDM D250	Flap O-Ring EPDM D250	1	1	23,70
37057 R 0401	O-Ring clapet EPDM D315	Flap O-Ring EPDM D315	1	1	35,34

CONJUNTO Lente - FLAP KIT					
CODE	DESCRIZIONE	DESCRIPTION	Fig.	Q	EUR
08984 R 0120	Clapet, O-Ring clapet e tappi D75	Flap, flap O-Ring & caps D75	1+3+4	1	9,68
08985 R 0120	Clapet, O-Ring clapet e tappi D90	Flap, flap O-Ring & caps D90	1+3+4	1	9,91
08986 R 0120	Clapet, O-Ring clapet e tappi D110	Flap, flap O-Ring & caps D110	1+3+4	1	11,43
09040 R 0120	Clapet, O-Ring clapet e tappi D125	Flap, flap O-Ring & caps D125	1+3+4	1	12,52
08987 R 0120	Clapet, O-Ring clapet e tappi D140	Flap, flap O-Ring & caps D140	1+3+4	1	14,60
08988 R 0120	Clapet, O-Ring clapet e tappi D160	Flap, flap O-Ring & caps D160	1+3+4	1	22,48
09041 R 0120	Clapet, O-Ring clapet e tappi D200	Flap, flap O-Ring & caps D200	1+3+4	1	26,17
08989 R 0120	Clapet, O-Ring clapet e tappi D225	Flap, flap O-Ring & caps D225	1+3+4	1	31,41
37056 R 0120	Clapet, O-Ring clapet e tappi D250	Flap, flap O-Ring & caps D250	1+3+4	1	49,66

O-Ring corpo FPM - BODY O-RING FPM					
CODE	DESCRIZIONE	DESCRIPTION	Fig.	Q	EUR
714 R 0914053	O-Ring corpo FPM D75	Body O-Ring FPM D75	2	2	27,67
714 R 1105053	O-Ring corpo FPM D90	Body O-Ring FPM D90	2	1	20,30
714 R 1359053	O-Ring corpo FPM D110	Body O-Ring FPM D110	2	1	22,92
714 R 1486053	O-Ring corpo FPM D125	Body O-Ring FPM D125	2	1	29,66
714 R 1600070	O-Ring corpo FPM D140	Body O-Ring FPM D140	2	1	50,55
714 R 1915070	O-Ring corpo FPM D160	Body O-Ring FPM D160	2	1	95,81
714 R 2216070	O-Ring corpo FPM D200	Body O-Ring FPM D200	2	1	70,56
714 R 2485070	O-Ring corpo FPM D225	Body O-Ring FPM D225	2	1	123,43

O-Ring clapet FPM - FLAP O-RING FPM					
CODE	DESCRIZIONE	DESCRIPTION	Fig.	Q	EUR
714 R 0407053	O-Ring clapet FPM D75	Flap O-Ring FPM D75	1	10	10,52
714 R 0565053	O-Ring clapet FPM D90	Flap O-Ring FPM D90	1	5	10,79
714 R 0724053	O-Ring clapet FPM D110	Flap O-Ring FPM D110	1	5	11,40
714 R 0819053	O-Ring clapet FPM D125	Flap O-Ring FPM D125	1	2	13,88
714 R 0914053	O-Ring clapet FPM D140	Flap O-Ring FPM D140	1	2	27,67
714 R 1137053	O-Ring clapet FPM D160	Flap O-Ring FPM D160	1	1	20,78
714 R 1359053	O-Ring clapet FPM D200	Flap O-Ring FPM D200	1	1	22,92
714 R 1486053	O-Ring clapet FPM D225	Flap O-Ring FPM D225	1	1	29,66

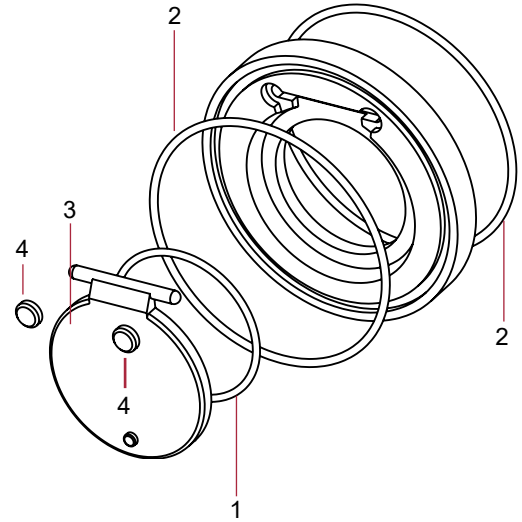

VALVOLA IDRAULICA IN PVC-U - PVC-U HYDRAULIC VALVE

C01 | 007 900

D63					
CODE	DESCRIZIONE	DESCRIPTION	Fig.	Q	EUR
11462 R 041	Membrana valvola idraulica	Hydraulic valve diaphragm	4	1	213,93
11462 R 0104	Ghiera valvola idraulica	Hydraulic valve nut	1	4	14,96

D90					
CODE	DESCRIZIONE	DESCRIPTION	Fig.	Q	EUR
27500 R 041	Membrana valvola idraulica	Hydraulic valve diaphragm	4	1	265,39

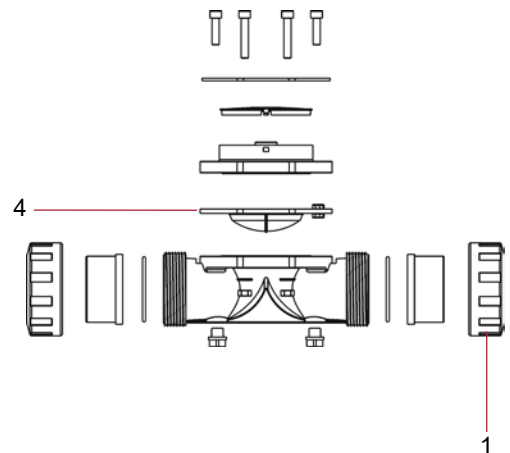

VALVOLE A FARFALLA SERIE STANDARD - STANDARD SERIES BUTTERFLY VALVES

C01 | 007 900

D63 / D75					
CODE	DESCRIZIONE	DESCRIPTION	Fig.	Q	EUR
32614 R 0124	Kit maniglia EPDM	Handle assembly EPDM	1+2+3+4+5	1	31,01
34532 R 0124	Kit maniglia FPM	Handle assembly FPM	1+2+3+4+5	1	31,01
32614 R 0130	Kit divisore	Dial plate assembly	6+7+8	1	16,03
32614 R 0129	Kit O-Ring perno EPDM	Shaft O-ring kit EPDM	9	1	10,20
34532 R 0129	Kit O-Ring perno FPM	Shaft O-ring kit FPM	9	1	15,00
32614 R 0121	Lente PVC-U	Disc PVC-U	10	1	18,34
32614 R 0118	O-Ring corpo EPDM	Body gasket EPDM	11	1	29,95
34532 R 0118	O-Ring corpo FPM	Body gasket FPM	11	1	135,86

D90					
CODE	DESCRIZIONE	DESCRIPTION	Fig.	Q	EUR
32616 R 0124	Kit maniglia EPDM	Handle assembly EPDM	1+2+3+4+5	1	31,73
34533 R 0124	Kit maniglia FPM	Handle assembly FPM	1+2+3+4+5	1	31,73
32614 R 0130	Kit divisore	Dial plate assembly	6+7+8	1	16,03
32615 R 0129	Kit O-Ring perno EPDM	Shaft O-ring kit EPDM	9	1	10,20
34533 R 0129	Kit O-Ring perno FPM	Shaft O-ring kit FPM	9	1	15,00
32615 R 0121	Lente PVC-U	Disc PVC-U	10	1	19,91
32615 R 0118	O-Ring corpo EPDM	Body gasket EPDM	11	1	31,60
34533 R 0118	O-Ring corpo FPM	Body gasket FPM	11	1	198,72

D110					
CODE	DESCRIZIONE	DESCRIPTION	Fig.	Q	EUR
32616 R 0124	Kit maniglia EPDM	Handle assembly EPDM	1+2+3+4+5	1	31,73
34534 R 0124	Kit maniglia FPM	Handle assembly FPM	1+2+3+4+5	1	31,73
32616 R 0130	Kit divisore	Dial plate assembly	6+7+8	1	16,25
32616 R 0129	Kit O-Ring perno EPDM	Shaft O-ring kit EPDM	9	1	10,63
34534 R 0129	Kit O-Ring perno FPM	Shaft O-ring kit FPM	9	1	20,95
32616 R 0121	Lente PVC-U	Disc PVC-U	10	1	26,59
32616 R 0118	O-Ring corpo EPDM	Body gasket EPDM	11	1	37,08
34534 R 0118	O-Ring corpo FPM	Body gasket FPM	11	1	289,61

D125 / D140					
CODE	DESCRIZIONE	DESCRIPTION	Fig.	Q	EUR
32617 R 0124	Kit maniglia EPDM	Handle assembly EPDM	1+2+3+4+5	1	35,60
34535 R 0124	Kit maniglia FPM	Handle assembly FPM	1+2+3+4+5	1	35,60
32616 R 0130	Kit divisore	Dial plate assembly	6+7+8	1	16,25
32617 R 0129	Kit O-Ring perno EPDM	Shaft O-ring kit EPDM	9	1	10,63
34535 R 0129	Kit O-Ring perno FPM	Shaft O-ring kit FPM	9	1	20,95
32617 R 0121	Lente PVC-U	Disc PVC-U	10	1	36,26
32617 R 0118	O-Ring corpo EPDM	Body gasket EPDM	11	1	43,42
34535 R 0118	O-Ring corpo FPM	Body gasket FPM	11	1	304,58

D160					
CODE	DESCRIZIONE	DESCRIPTION	Fig.	Q	EUR
32617 R 0124	Kit maniglia EPDM	Handle assembly EPDM	1+2+3+4+5	1	35,60
34535 R 0124	Kit maniglia FPM	Handle assembly FPM	1+2+3+4+5	1	35,60
32616 R 0130	Kit divisore	Dial plate assembly	6+7+8	1	16,25
32617 R 0129	Kit O-Ring perno EPDM	Shaft O-ring kit EPDM	9	1	10,63
34535 R 0129	Kit O-Ring perno FPM	Shaft O-ring kit FPM	9	1	20,95
32618 R 0121	Lente PVC-U	Disc PVC-U	10	1	42,59
32618 R 0118	O-Ring corpo EPDM	Body gasket EPDM	11	1	60,13
34536 R 0118	O-Ring corpo FPM	Body gasket FPM	11	1	481,15

D200 / D225					
CODE	DESCRIZIONE	DESCRIPTION	Fig.	Q	EUR
32619 R 0124	Kit maniglia EPDM	Handle assembly EPDM	1+2+3+4+5	1	47,67
34537 R 0124	Kit maniglia FPM	Handle assembly FPM	1+2+3+4+5	1	47,67
32619 R 0130	Kit divisore	Dial plate assembly	6+7+8	1	28,40
32619 R 0129	Kit O-Ring perno EPDM	Shaft O-ring kit EPDM	9	1	11,16
34537 R 0129	Kit O-Ring perno FPM	Shaft O-ring kit FPM	9	1	25,72
32619 R 0121	Lente PVC-U	Disc PVC-U	10	1	98,09
32619 R 0118	O-Ring corpo EPDM	Body gasket EPDM	11	1	97,83
34537 R 0118	O-Ring corpo FPM	Body gasket FPM	11	1	778,97

D250					
CODE	DESCRIZIONE	DESCRIPTION	Fig.	Q	EUR
10086 R 0124	Kit maniglia EPDM	Handle assembly EPDM	1+2+3+4+5	1	541,39
46647 R 0130	Kit divisore	Dial plate assembly	6+7+8	1	32,81
46647 R 0129	Kit O-Ring perno EPDM	Shaft O-ring kit EPDM	9	1	11,92
34472 R 0121	Lente PVC-U	Disc PVC-U	10	1	153,74
46647 R 0118	O-Ring corpo EPDM	Body gasket EPDM	11	1	166,10

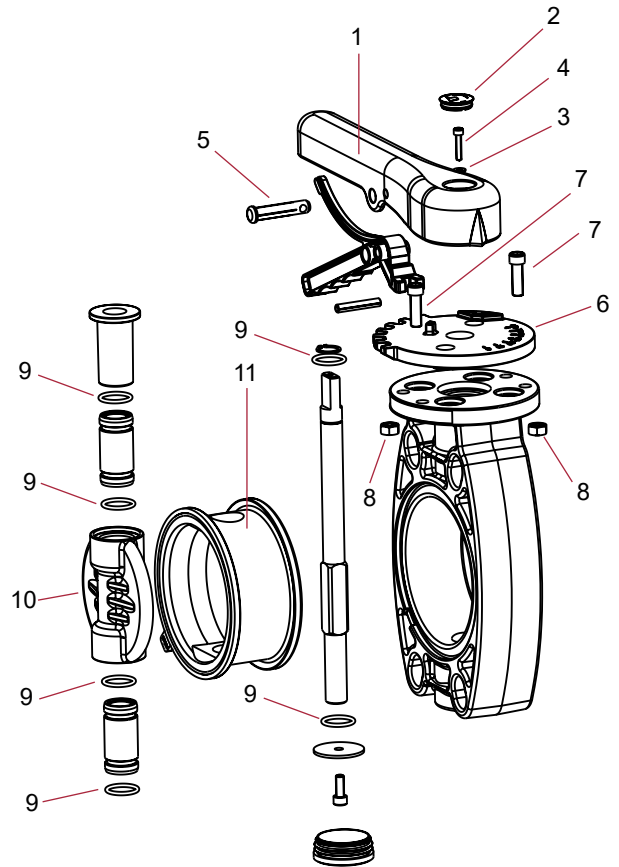

Accessori PVC-U
 Valvole PVC-U
 Accessori PVC-C
 Valvole PVC-C
 Valvole Extreme
 Evacuazione
 Ricambi

VALVOLE A FARFALLA SERIE INDUSTRIAL - INDUSTRIAL SERIES BUTTERFLY VALVES

C01 | 007 900

D63 / D75		Fig.	Q	EUR	
32614 R 0124	Kit maniglia EPDM	Handle assembly EPDM	1+2+3+4+5	1	31,01
34532 R 0124	Kit maniglia FPM	Handle assembly FPM	1+2+3+4+5	1	31,01
32614 R 0130	Kit divisore	Dial plate assembly	6+7+8	1	16,03
32620 R 0129	Kit O-Ring perno EPDM Perox.	Shaft O-ring kit Perox. EPDM	9	1	0,63
34532 R 0129	Kit O-Ring perno FPM	Shaft O-ring kit FPM	9	1	15,00
32614 R 0121	Lente PVC-U	Disc PVC-U	10	1	18,34
34480 R 0121	Lente PVC-C	Disc PVC-C	10	1	20,61
34506 R 0121	Lente PP-H	Disc PP-H	10	1	29,21
32620 R 0118	O-Ring corpo EPDM Perox.	Body gasket Perox. EPDM	11	1	56,12
34532 R 0118	O-Ring corpo FPM	Body gasket FPM	11	1	135,86

D90		Fig.	Q	EUR	
32615 R 0124	Kit maniglia EPDM	Handle assembly EPDM	1+2+3+4+5	1	31,73
34533 R 0124	Kit maniglia FPM	Handle assembly FPM	1+2+3+4+5	1	31,73
32616 R 0130	Kit divisore	Dial plate assembly	6+7+8	1	16,03
32621 R 0129	Kit O-Ring perno EPDM Perox.	Shaft O-ring kit Perox. EPDM	9	1	11,10
34533 R 0129	Kit O-Ring perno FPM	Shaft O-ring kit FPM	9	1	15,00
32615 R 0121	Lente PVC-U	Disc PVC-U	10	1	19,91
34481 R 0121	Lente PVC-C	Disc PVC-C	10	1	23,04
34507 R 0121	Lente PP-H	Disc PP-H	10	1	29,51
32621 R 0118	O-Ring corpo EPDM Perox.	Body gasket Perox. EPDM	11	1	58,39
34533 R 0118	O-Ring corpo FPM	Body gasket FPM	11	1	198,72

D110		Fig.	Q	EUR	
32616 R 0124	Kit maniglia EPDM	Handle assembly EPDM	1+2+3+4+5	1	31,73
34534 R 0124	Kit maniglia FPM	Handle assembly FPM	1+2+3+4+5	1	31,73
32616 R 0130	Kit divisore	Dial plate assembly	6+7+8	1	16,25
32622 R 0129	Kit O-Ring perno EPDM Perox.	Shaft O-ring kit Perox. EPDM	9	1	13,49
34534 R 0129	Kit O-Ring perno FPM	Shaft O-ring kit FPM	9	1	20,95
32616 R 0121	Lente PVC-U	Disc PVC-U	10	1	26,59
33961 R 0121	Lente PVC-C	Disc PVC-C	10	1	31,14
33963 R 0121	Lente PP-H	Disc PP-H	10	1	33,57
32622 R 0118	O-Ring corpo EPDM Perox.	Body gasket Perox. EPDM	11	1	65,34
34534 R 0118	O-Ring corpo FPM	Body gasket FPM	11	1	289,61

D125 / D140		Fig.	Q	EUR	
32617 R 0124	Kit maniglia EPDM	Handle assembly EPDM	1+2+3+4+5	1	35,60
34535 R 0124	Kit maniglia FPM	Handle assembly FPM	1+2+3+4+5	1	35,60
32616 R 0130	Kit divisore	Dial plate assembly	6+7+8	1	16,25
32623 R 0129	Kit O-Ring perno EPDM Perox.	Shaft O-ring kit Perox. EPDM	9	1	13,49
34535 R 0129	Kit O-Ring perno FPM	Shaft O-ring kit FPM	9	1	20,95
32617 R 0121	Lente PVC-U	Disc PVC-U	10	1	36,26
34482 R 0121	Lente PVC-C	Disc PVC-C	10	1	46,54
34508 R 0121	Lente PP-H	Disc PP-H	10	1	43,96
32623 R 0118	O-Ring corpo EPDM Perox.	Body gasket Perox. EPDM	11	1	73,31
34535 R 0118	O-Ring corpo FPM	Body gasket FPM	11	1	304,58

D160		Fig.	Q	EUR	
32617 R 0124	Kit maniglia EPDM	Handle assembly EPDM	1+2+3+4+5	1	35,60
34535 R 0124	Kit maniglia FPM	Handle assembly FPM	1+2+3+4+5	1	35,60
32616 R 0130	Kit divisore	Dial plate assembly	6+7+8	1	16,25
32623 R 0129	Kit O-Ring perno EPDM Perox.	Shaft O-ring kit Perox. EPDM	9	1	13,49
34535 R 0129	Kit O-Ring perno FPM	Shaft O-ring kit FPM	9	1	20,95
32618 R 0121	Lente PVC-U	Disc PVC-U	10	1	42,59
34483 R 0121	Lente PVC-C	Disc PVC-C	10	1	60,16
34509 R 0121	Lente PP-H	Disc PP-H	10	1	48,00
32624 R 0118	O-Ring corpo EPDM Perox.	Body gasket Perox. EPDM	11	1	92,58
34536 R 0118	O-Ring corpo FPM	Body gasket FPM	11	1	481,15

D200 / D225		Fig.	Q	EUR	
32619 R 0124	Kit maniglia EPDM	Handle assembly EPDM	1+2+3+4+5	1	47,67
34537 R 0124	Kit maniglia FPM	Handle assembly FPM	1+2+3+4+5	1	47,67
32619 R 0130	Kit divisore	Dial plate assembly	6+7+8	1	28,40
32625 R 0129	Kit O-Ring perno EPDM Perox.	Shaft O-ring kit Perox. EPDM	9	1	16,32
34537 R 0129	Kit O-Ring perno FPM	Shaft O-ring kit FPM	9	1	25,72
32619 R 0121	Lente PVC-U	Disc PVC-U	10	1	98,09
34484 R 0121	Lente PVC-C	Disc PVC-C	10	1	141,26
34510 R 0121	Lente PP-H	Disc PP-H	10	1	77,84
32625 R 0118	O-Ring corpo EPDM Perox.	Body gasket Perox. EPDM	11	1	159,90
34537 R 0118	O-Ring corpo FPM	Body gasket FPM	11	1	778,97

D250 / D280		Fig.	Q	EUR	
34472 R 0129	Kit O-Ring perno EPDM Perox.	Shaft O-ring kit Perox. EPDM	9	1	18,39
34479 R 0129	Kit O-Ring perno FPM	Shaft O-ring kit FPM	9	1	56,12
34472 R 0121	Lente PVC-U	Disc PVC-U	10	1	153,74
34496 R 0121	Lente PVC-C	Disc PVC-C	10	1	213,72
34522 R 0121	Lente PP-H	Disc PP-H	10	1	121,63
34472 R 0118	O-Ring corpo EPDM Perox.	Body gasket Perox. EPDM	11	1	327,40
34479 R 0118	O-Ring corpo FPM	Body gasket FPM	11	1	1.695,17

D315		Fig.	Q	EUR	
34472 R 0129	Kit O-Ring perno EPDM Perox.	Shaft O-ring kit Perox. EPDM	9	1	18,39
34479 R 0129	Kit O-Ring perno FPM	Shaft O-ring kit FPM	9	1	56,12
32738 R 0121	Lente PVC-U	Disc PVC-U	10	1	223,46
34497 R 0121	Lente PVC-C	Disc PVC-C	10	1	299,17
34523 R 0121	Lente PP-H	Disc PP-H	10	1	151,78
32738 R 0118	O-Ring corpo EPDM Perox.	Body gasket Perox. EPDM	11	1	410,08
32739 R 0118	O-Ring corpo FPM	Body gasket FPM	11	1	1.906,93

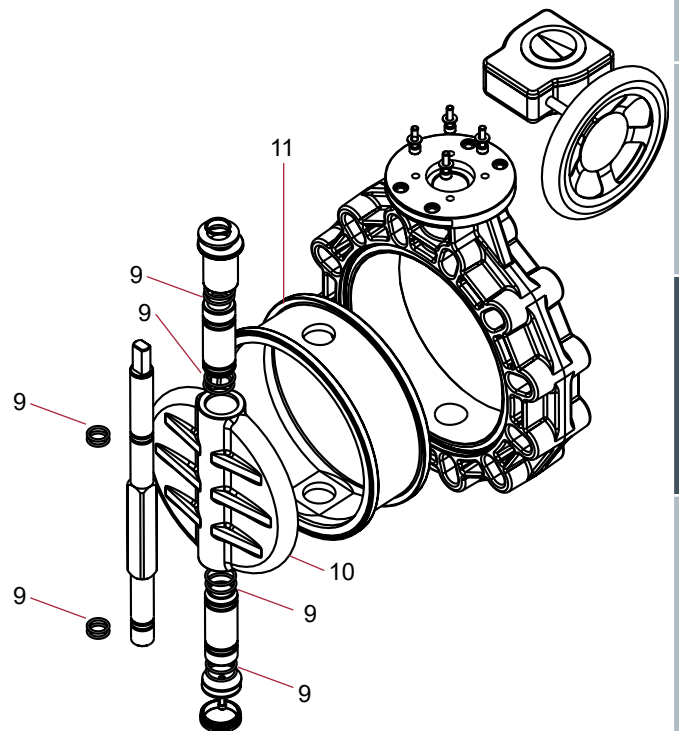
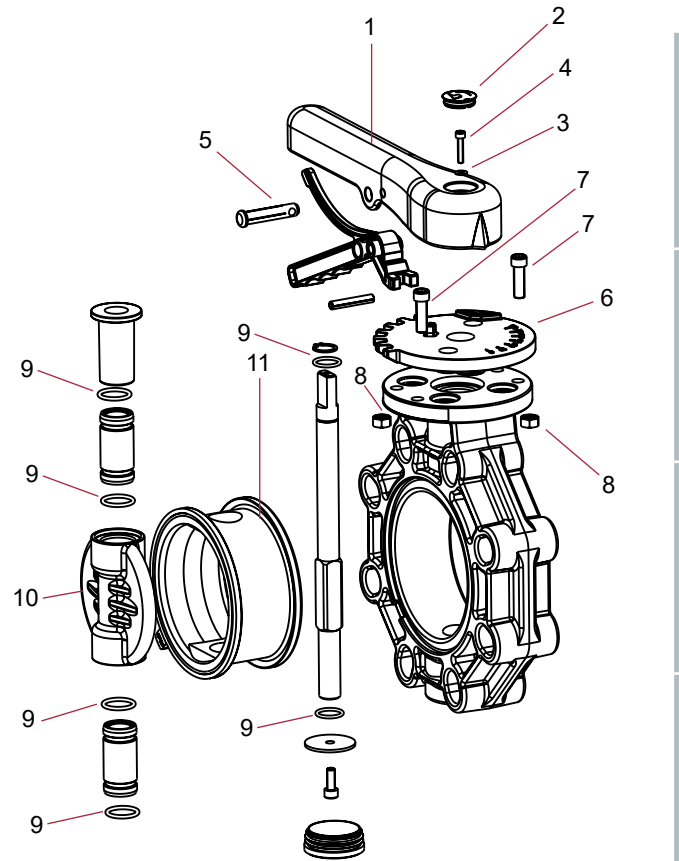

Accessori PVC-U

Valvole PVC-U

Accessori PVC-C

Valvole PVC-C

Valvole Extreme

Evacuazione

Ricambi

VALVOLE A FARFALLA IN PVC-U SERIE CLASSIC - PVC-U BUTTERFLY VALVES CLASSIC SERIES

C01 | 007 900

Accessori PVC-U

Valvole PVC-U

Accessori PVC-C

Valvole PVC-C

Valvole Extreme

Evacuazione

Ricambi

		D63 / D75				
CODE	DESCRIZIONE	DESCRIPTION	Fig.	Q	EUR	
02581 R 0124	Kit maniglia	Handle assembly	1	1	52,67	
02581 R 0130	Kit divisore	Dial plate assembly	2	1	23,79	
02581 R 0121	Lente + perno a. zincato + O-Ring EPDM	Disc, zinc plated shaft + EPDM O-Rings	3+5	1	20,66	
16707 R 0121	Lente + perno a. inox + O-Ring EPDM	Disc, stainless shaft + EPDM O-Rings	3+5	1	103,23	
02581 R 0118	O-Ring corpo EPDM	Body gasket EPDM	4	1	49,63	
723 R 0124018	O-Ring perno EPDM	Shaft O-Ring EPDM	5	10	0,45	
02590 R 0118	O-Ring corpo FPM	Body gasket FPM	4	1	225,78	
714 R 0124018	O-Ring perno FPM	Shaft O-Ring FPM	5	10	1,38	

		D90				
CODE	DESCRIZIONE	DESCRIPTION	Fig.	Q	EUR	
02582 R 0124	Kit maniglia	Handle assembly	1	1	58,67	
02581 R 0130	Kit divisore	Dial plate assembly	2	1	23,79	
02582 R 0121	Lente + perno a. zincato + O-Ring EPDM	Disc, zinc plated shaft + EPDM O-Rings	3+5	1	28,52	
16708 R 0121	Lente + perno a. inox + O-Ring EPDM	Disc, stainless shaft + EPDM O-Rings	3+5	1	118,84	
02582 R 0118	O-Ring corpo EPDM	Body gasket EPDM	4	1	56,51	
723 R 0139026	O-Ring perno EPDM	Shaft O-Ring EPDM	5	10	0,59	
02591 R 0118	O-Ring corpo FPM	Body gasket FPM	4	1	322,53	
714 R 0139026	O-Ring perno FPM	Shaft O-Ring FPM	5	10	2,25	

		D110				
CODE	DESCRIZIONE	DESCRIPTION	Fig.	Q	EUR	
02583 R 0124	Kit maniglia	Handle assembly	1	1	51,95	
02581 R 0130	Kit divisore	Dial plate assembly	2	1	23,79	
02583 R 0121	Lente + perno a. zincato + O-Ring EPDM	Disc, zinc plated shaft + EPDM O-Rings	3+5	1	37,67	
16709 R 0121	Lente + perno a. inox + O-Ring EPDM	Disc, stainless shaft + EPDM O-Rings	3+5	1	174,58	
02583 R 0118	O-Ring corpo EPDM	Body gasket EPDM	4	1	63,00	
723 R 0188018	O-Ring perno EPDM	Shaft O-Ring EPDM	5	10	0,45	
02592 R 0118	O-Ring corpo FPM	Body gasket FPM	4	1	458,39	
714 R 0188018	O-Ring perno FPM	Shaft O-Ring FPM	5	10	1,82	

		D125 / D140				
CODE	DESCRIZIONE	DESCRIPTION	Fig.	Q	EUR	
02585 R 0124	Kit maniglia	Handle assembly	1	1	72,66	
02581 R 0130	Kit divisore	Dial plate assembly	2	1	23,79	
02585 R 0121	Lente + perno a. zincato + O-Ring EPDM	Disc, zinc plated shaft + EPDM O-Rings	3+5	1	48,90	
16710 R 0121	Lente + perno a. inox + O-Ring EPDM	Disc, stainless shaft + EPDM O-Rings	3+5	1	233,82	
02585 R 0118	O-Ring corpo EPDM	Body gasket EPDM	4	1	79,92	
723 R 0219026	O-Ring perno EPDM	Shaft O-Ring EPDM	5	10	0,59	
02594 R 0118	O-Ring corpo FPM	Body gasket FPM	4	1	543,79	
714 R 0219026	O-Ring perno FPM	Shaft O-Ring FPM	5	10	2,50	

		D160				
CODE	DESCRIZIONE	DESCRIPTION	Fig.	Q	EUR	
02586 R 0124	Kit maniglia	Handle assembly	1	1	72,66	
02581 R 0130	Kit divisore	Dial plate assembly	2	1	23,79	
02586 R 0121	Lente + perno a. zincato + O-Ring EPDM	Disc, zinc plated shaft + EPDM O-Rings	3+5	1	63,00	
16711 R 0121	Lente + perno a. inox + O-Ring EPDM	Disc, stainless shaft + EPDM O-Rings	3+5	1	271,00	
02586 R 0118	O-Ring corpo EPDM	Body gasket EPDM	4	1	95,70	
723 R 0234035	O-Ring perno EPDM	Shaft O-Ring EPDM	5	10	0,66	
02595 R 0118	O-Ring corpo FPM	Body gasket FPM	4	1	791,26	
714 R 0234035	O-Ring perno FPM	Shaft O-Ring FPM	5	10	3,40	

		D200 / D225				
CODE	DESCRIZIONE	DESCRIPTION	Fig.	Q	EUR	
02587 R 0124	Kit maniglia	Handle assembly	1	1	102,81	
02587 R 0130	Kit divisore	Dial plate assembly	2	1	33,64	
02587 R 0121	Lente + perno a. zincato + O-Ring EPDM	Disc, zinc plated shaft + EPDM O-Rings	3+5	1	112,05	
16712 R 0121	Lente + perno a. inox + O-Ring EPDM	Disc, stainless shaft + EPDM O-Rings	3+5	1	336,32	
02587 R 0118	O-Ring corpo EPDM	Body gasket EPDM	4	1	145,29	
723 R 0300040	O-Ring perno EPDM	Shaft O-Ring EPDM	5	10	1,20	
02596 R 0118	O-Ring corpo FPM	Body gasket FPM	4	1	1.056,43	
714 R 0300040	O-Ring perno FPM	Shaft O-Ring FPM	5	10	4,48	

		D250				
CODE	DESCRIZIONE	DESCRIPTION	Fig.	Q	EUR	
15846 R 0124	Kit maniglia	Handle assembly	4	1	103,49	
02587 R 0130	Kit divisore	Dial plate assembly	5	1	33,64	
15846 R 0101	Lente	Disc	3	1	115,15	
15846 R 0110	Giunta Lente EPDM	Disc gasket EPDM	2	1	65,99	
723 R 0380035	Giunta Lente EPDM	Shaft O-Rings EPDM	1	8	0,83	
16868 R 0118	Giunta Lente FPM	Disc gaskets FPM	2	1	494,29	
714 R 0380035	O-ring lente EPDM	Shaft O-Rings FPM	1	8	6,22	
	O-ring perno EPDM					
	O-ring lente FPM					
	O-ring perno FPM					

**VALVOLE A FARFALLA IN PVC-U
D63-D225**

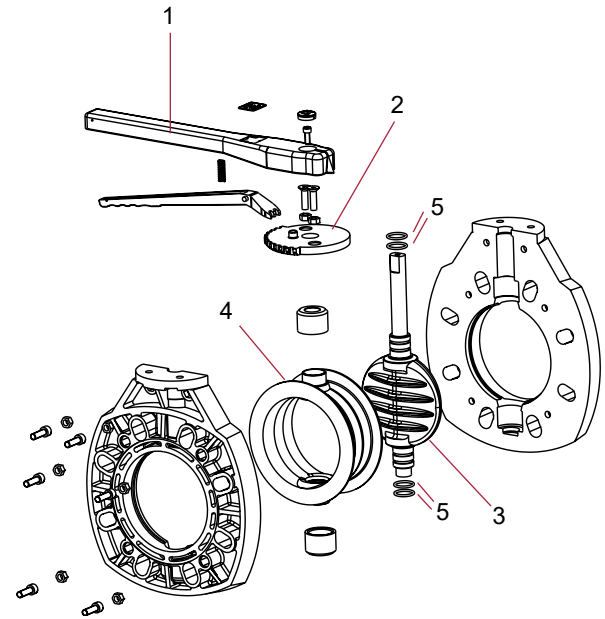

**VALVOLE A FARFALLA IN PVC-U
D250**

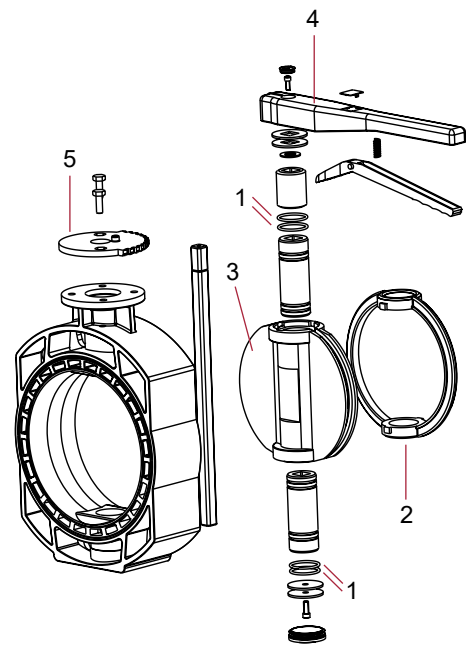

VALVOLA A SEDE INCLINATA REGOLATRICE - ANGLE SEAT REGULATOR VALVE

C01 | 007 900

D20 - 1/2" (REGOLATRICE - REGULATOR)					
CODE	DESCRIZIONE	DESCRIPTION	Fig.	Q	EUR
22885 R 0124	Volantino	Handwheel assembly	1+2+3	4	4,63
22885 R 0102	Ghiera superiore	Bonnetnut	4	10	2,79
22885 R 0125	Kit di tenuta	Sealing assembly	6+7	10	2,50
22885 R 0129	Kit conico	Conical assembly	8+9+10	5	7,73
723 R 0202035	O-Ring EPDM (3 pezzi)	EPDM o-ring (union)	15	10	0,76
02172 R 0101	Manicotto 3 pezzi D20	20 mm connection (Union)	13	10	1,05
02188 R 0103	Ghiera 3 pezzi 1"	Union nut 1"	14	10	2,55

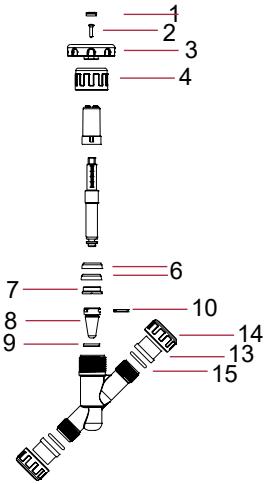

VALVOLA A SEDE INCLINATA ANTIRITORNO - ANGLE SEAT CHECK VALVE

C01 | 007 900

D20 - 1/2" (ANTI-RITORNO - CHECK)					
CODE	DESCRIZIONE	DESCRIPTION	Fig.	Q	EUR
22889 R 0112	Anello di sicurezza	Safety ring	1	10	0,94
22889 R 0107	Kit tappo + Guarnizione	Cap + O-ring assembly	3+4	5	3,26
22889 R 0101	Kit perno antiritorno	Disc bonnet assembly	5+6	5	9,79
22889 R 0136	Guarnizione piatta perno	Disc assembly	6	5	0,36
22885 R 0102	Ghiera superiore	Bonnetnut	2	10	2,79
723 R 0202035	O-Ring EPDM (3 pezzi)	EPDM o-ring (union)	15	10	0,76
02172 R 0101	Manicotto 3 pezzi D20	20 mm connection (union)	13	10	1,05
02188 R 0103	Ghiera 3 pezzi 1"	Union nut 1"	14	10	2,55

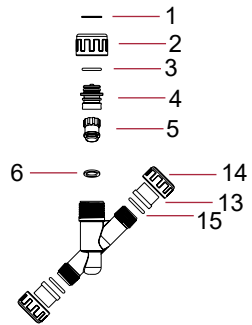

RACCOGLITORE DI IMPURITÀ - LINE STRAINER

C01 | 007 900

D20 - 1/2" (FILTRO - LINE STRAINER)					
CODE	DESCRIZIONE	DESCRIPTION	Fig.	Q	EUR
25713 R 0106	Rete	Screen	5	5	1,25
22885 R 0102	Ghiera superiore	Bonnetnut	2	10	2,79
22889 R 0112	Anello di sicurezza	Safety ring	1	10	0,94
22889 R 0107	Kit tappo + Guarnizione	Cap + O-ring assembly	3+4	5	3,26
723 R 0202035	O-Ring EPDM (3 pezzi)	EPDM o-ring (union)	15	10	0,76
02172 R 0101	Manicotto 3 pezzi D20	20 mm connection (union)	13	10	1,05
02188 R 0103	Ghiera 3 pezzi 1"	Union nut 1"	14	10	2,55

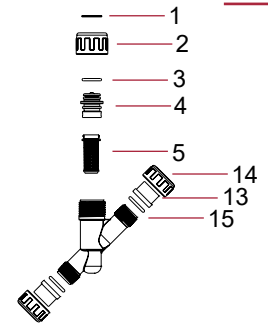

VALVOLE SELETRICI CON LENTE ROTANTE - ROTARY DISC VALVES

C01 | 007 900

D50 - D63					
CODE	DESCRIZIONE	DESCRIPTION	Fig.	Q	EUR
16059 R 0124	Kit maniglia valv. 2 e 3 vie	Handle assembly 2-3 way valve	1+2+3	4	7,72
16059 R 0121	Kit perno valv. 2 e 3 vie	Shaft assembly 2-3 way valve	9+10+11+12	4	32,10
16059 R 0129	Kit O-Ring perno	Shaft O-Rings kit	7+8	4	2,50
723 R 0758035	Guarnizione corpo	Body O-Ring	6	5	1,30
16059 R 0013	Coperchio + Kit guarniz.	Cover + O-rings kit	6+7+8+13	1	14,69

D63 - D75					
CODE	DESCRIZIONE	DESCRIPTION	Fig.	Q	EUR
41862 R 0124	Kit maniglia valv. 2 e 3 vie	Handle assembly 3-way valve	1+2+3	4	8,84
41862 R 0121	Kit perno valv. 2 e 3 vie	Shaft assembly 3-way valve	9+10+11+12	4	26,97
41862 R 0129	Kit O-Ring perno	Shaft O-Rings kit	7+8	4	2,44
723 R 0853035	Guarnizione corpo	Body O-Ring	6	5	4,00

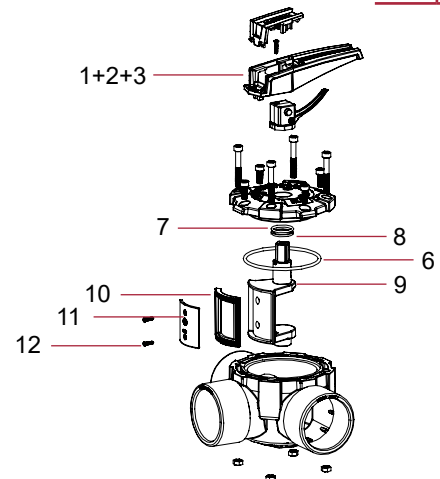

Accessori PVC-U
 Valvole PVC-U
 Accessori PVC-C
 Valvole PVC-C
 Valvole Extreme
 Evacuazione
 Ricambi

Condizioni generali di vendita

1. AMBITO DI APPLICAZIONE

Le presenti condizioni di vendita si applicheranno a tutti gli ordini ricevuti da Fluidra. Qualunque variazione alle condizioni di vendita dovrà essere espressamente accettata per iscritto da parte di Fluidra. I prezzi e condizioni commerciali di vendita potranno essere da noi rivisti in qualunque momento per tutte o parte delle attività in corso alla data della modifica.

2. ORDINI

Al fine di evitare errori e per una migliore gestione dell'ordine stesso, ivi compresa la consegna delle merci, gli ordini dovranno rimettersi per iscritto concordemente ai riferimenti ed alle descrizioni del listino prezzi in vigore, adeguando le quantità agli standard fissati nello stesso.

3. CONSEGNE

L'evasione degli ordini avrà luogo nei quattro (4) giorni lavorativi successivi al loro ricevimento, sempre e quando si disponga delle esistenze sufficienti a farvi fronte. Il mancato rispetto della data di consegna non autorizza l'acquirente ad annullare l'ordine, né ad esigere indennizzo o compenso alcuno.

L'acquirente rinuncia espressamente all'esercizio delle azioni che possano competergli per ritardi, quando questi siano dovuti a circostanze involontarie e/o di forza maggiore o quando egli stesso non abbia adempiuto a tutti o parte dei suoi obblighi. Per data di consegna si intenderà sempre quella di uscita dai nostri depositi.

4. PREZZI

I prezzi si intendono sempre IVA esclusa "Franco magazzino di partenza", imballaggi esclusi, ad eccezione dei prezzi speciali (netti o raccomandati al pubblico iva inclusa, debitamente segnalati), essendo a carico dell'acquirente tutte le imposte ed ogni altra spesa. Le consegne degli ordini verranno fatturate in base al listino in vigore al momento dell'ordine.

5. TRASPORTO

Per quanto riguarda il prezzo di listino per la consegna delle merci si specifica che qualunque spesa supplementare non rientrante nelle tariffe standard Fluidra (imballaggi marittimi, trasporto aereo, trasporti eccezionali ecc.) sarà considerata sempre come sostenuta a carico ed a rischio del compratore.

6. GARANZIA

Tutti i nostri prodotti sono garantiti per vizi di fabbricazione per il periodo di 2 anni, a partire dalla data del documento di trasporto, tranne che per prodotti specifici e/o soggetti ad usura, per i quali la garanzia è ridotta ad 1 anno o assente. L'acquirente è tenuto ad informarsi relativamente al periodo di garanzia del prodotto acquistato.

La nostra garanzia comprende unicamente ed esclusivamente la riparazione o sostituzione dei pezzi difettosi presso la nostra sede. Non sono inclusi indennizzi o altre spese accessorie.

La garanzia perde validità se i difetti derivano da un trattamento scorretto della merce, oppure quando i prodotti siano stati manipolati, riparati o modificati al di fuori dai nostri impianti produttivi, oppure installati con materiali o procedimenti non a norma di Legge.

La parte che adduca l'esistenza di un difetto di fabbricazione dovrà fornire prova dell'adeguato impiego del prodotto e, in tal caso, della corretta installazione dello stesso. Le spese di restituzione e rinvio dei materiali difettosi saranno a carico dell'acquirente.

7. PAGAMENTI

Salvo patto contrario redatto per iscritto e concordato con Fluidra, tutti i pagamenti dovranno essere effettuati tramite Ri.ba. Tutte le spese, tasse ed imposte applicabili al momento dell'invio dell'ordine, o posteriormente allo stesso, sono a carico dell'acquirente.

L'importo minimo di acquisto è fissato in € 80,00. Acquisti di importo inferiore non saranno accettati.

Qualsiasi ritardo nei pagamenti o nell'accettazione di effetti per lo stesso, darà luogo ad un interesse mensile secondo i tassi ufficiali, applicato a partire dalla data di scadenza e senza necessità di notificazioni od intimazioni all'acquirente.

Qualunque modifica relativa alla forma ed alla data di scadenza del pagamento dovrà essere autorizzata per iscritto da Fluidra.

Ugualmente l'acquirente rimborserà a Fluidra, in qualità di danni e pregiudizi, le spese bancarie e giudiziarie determinatesi a causa della restituzione di effetti insoluti.

8. RECLAMI E RESTITUZIONI

Non si ammetteranno restituzioni o reclami trascorsi otto (8) giorni dal ricevimento della merce. Nel caso in cui dessimo il nostro consenso alla restituzione, la merce dovrà essere rinviata ai nostri magazzini perfettamente imballata e libera da spese di trasporto.

Le restituzioni non conformi saranno respinte ed i rischi e le spese saranno considerate a carico dell'acquirente.

In caso di rescissione o annullamento di prodotti speciali, la cui realizzazione è eseguita in conformità a caratteristiche e disegni richiesti dall'acquirente.

A norma di Legge, il diritto di recesso non può essere esercitato da clienti con partita Iva.

Gli accrediti corrispondenti alle restituzioni accettate verranno annotati nel conto dell'acquirente e portati in deduzione dalle successive fatture.

9. ANNULLAMENTI

Senza pregiudizio di altri reclami che potrebbero corrisponderci, ci riserviamo il diritto di annullare qualsiasi ordine in caso di inadempimento di una qualunque delle presenti condizioni, così come nei casi di insolvenza parziale o totale di un ordine o ritardo nel pagamento di forniture anteriori.

Verranno inoltre intrapresi contro l'acquirente procedimenti esecutivi, se questi dichiarerà lo stato di insolvenza o fallimento.

In caso di rescissione o annullamento da parte del compratore dell'intero ordine o di parte di esso, attuata senza previo accordo, l'indennizzo spettante a Fluidra sarà equivalente al 10% del valore delle merci a cui si riferisce tale rescissione o annullamento, senza impedimento del fatto che Fluidra possa esigere il risarcimento dei danni o pregiudizi determinati dall'annullamento dell'ordine.

10. RISERVATEZZA

L'acquirente ha l'obbligo di mantenere riservate tutte le informazioni fornite da Fluidra e si impegna ad impedire la divulgazione delle stesse.

11. RISERVA DI DOMINIO

Fluidra mantiene la proprietà della merce venduta fino a quando l'acquirente non abbia effettuato tutti i pagamenti. Fluidra si riserva inoltre il diritto di ritirare le merci dal domicilio del compratore in misura parziale o totale.

12. DIRITTO DI PROPRIETÀ INTELLETTUALE O INDUSTRIALE

Tutte le grafiche, disegni, progetti, loghi, fotografie e testi contenuti nel presente catalogo e in tutti i cataloghi e siti web di proprietà di Fluidra sono protetti dal diritto d'autore e ne è vietata la riproduzione, anche parziale, senza espresso consenso di Fluidra. È fatto divieto dell'uso dei loghi, dei disegni, dei progetti, delle fotografie e grafiche, nonché degli altri diritti di proprietà industriale ed intellettuale di Fluidra, inclusa la riproduzione su siti internet, cataloghi, volantini o qualunque altro supporto da parte di soggetti non specificamente autorizzati. L'acquirente riconosce espressamente la proprietà di questi diritti e accetta che non acquisirà alcun diritto di proprietà intellettuale o industriale derivato dal rapporto contrattuale tra le parti, rimanendo obbligato a rispettare tali diritti, nonché a non rivendicare in alcun modo, contraddire, limitare, registrare i diritti suddetti.

Tutte le informazioni divulgate ai fini del rapporto contrattuale da una delle parti saranno di proprietà di ciascuna di esse e nessuna licenza, patente, brevetto o similari può essere considerata derivata dallo scambio di informazioni tra le parti. La proprietà dei diritti di proprietà intellettuale o industriale deve corrispondere alla parte che li ha originati. Nessuna delle parti può in alcun caso avviare una domanda di registrazione per proteggere i diritti di proprietà intellettuale o industriale che potrebbero derivare dalle informazioni fornite dall'altra parte.

Allo stesso modo, attraverso queste condizioni generali di vendita l'acquirente acquisisce l'impegno e accetta di non richiedere la registrazione di qualsiasi nome di dominio che includa, in tutto o in parte, il riferimento ai marchi di proprietà di Fluidra e / o del Gruppo Fluidra. Questo impegno viene acquisito per tutti i Paesi in cui Fluidra e / o il Gruppo Fluidra detengono marchi ai sensi della normativa vigente. Allo stesso modo, l'acquirente rinuncia espressamente a tutti i diritti che possono derivare dall'uso dei marchi della Società e / o del Gruppo Fluidra. Nel caso in cui l'acquirente violi questa clausola, Fluidra si riserva il diritto di risolvere unilateralmente le presenti condizioni generali di vendita, oltre al diritto di avviare tutte le azioni legali che potrebbero essere pertinenti.

13. GIURISDIZIONE E COMPETENZA

Qualunque controversia tra le parti sarà sottomessa alla giurisdizione e competenza esclusiva del tribunale della giurisdizione in cui ha sede Fluidra.

CI RISERVIAMO IL DIRITTO DI MODIFICARE SENZA PREVIO AVVISO, TOTALMENTE O PARZIALMENTE, IL CONTENUTO DI QUESTO DOCUMENTO.



 **CEPEX**[®]

FLUIDRA

FLUIDRA COMMERCIALE ITALIA S.p.A.

via Tre Bocche 7/G

25081 Bedizzole (BS) Italia

Tel. Centralino: + 39 030 6870441

Tel. Ufficio Tecnico e Post Vendita: +39 030 6348999

Tel. Assistenza Commerciale: +39 030 674099

www.cepex.com/it